

PRODUCT SPECIFICATIONS

Elkay Crosstown® 18 Gauge Stainless Steel, 25" x 22" x 9" Single Bowl Dual Mount Sink Kit with Filtered Beverage Faucet. Sink is manufactured from 18 gauge 304 Stainless Steel with a Stainless Steel finish, Rear Center drain placement, and Full spray sides and bottom with Sides and Bottom pads.

Installation Type:	Undermount, Drop-in, Sink Kits
Material:	304 Stainless Steel
Special Features:	Slim Rim
Finish:	Stainless Steel
Gauge:	18
Sound Deadening:	Full spray sides and bottom with Sides and Bottom pads
Number of Bowls:	1
Sink Dimensions:	25" x 22" x 9"
Bowl 1 Dimensions:	22-1/2" x 16-3/4" x 9"
Drain Size:	3-1/2" (89mm)
Drain Location:	Rear Center
Minimum Cabinet Size:	30"
Mounting Hardware:	Included
Template Included:	Yes
Cutout Template #:	1000001179

Template is available for download at elkay.com. CAD software will be required to open the template.

Cutout Dimensions for Drop-in Installation:

24-3/8" x 21-3/8" (619mm x 543mm) with 1/2" (12mm) corner radius

Special Note: Kitchen faucet sold separately



Included with Product: LKAV71FLS Beverage Faucet and Filter with ECTSR25229T Sink, CTXBG2115 Bottom Grid

A Century of Tradition and Quality.

For more than 100 years, Elkay has been making innovative products and providing exceptional customer care. We take pride in offering plumbing products that make life easier, inspire change and leave the world a better place.

Product Compliance: ASME A112.19.3/CSA B45.4
 Faucet: ASME A112.18.1/CSA B125.1
 NSF 61
 NSF 372 (lead free)
 Accessory: NSF 42
 NSF 53

[Clean and Care Manual \(PDF\)](#)
[Installation Instructions \(PDF\) - 1000005237](#)
[Warranty \(PDF\)](#)

PART: _____ QTY: _____

PROJECT: _____

CONTACT: _____

DATE: _____



NOTES: _____

APPROVAL: _____

In keeping with our policy of continuing product improvement, Elkay reserves the right to change product specifications without notice. Please visit elkay.com for the most current version of Elkay product specification sheets. This specification describes an Elkay product with design, quality, and functional benefits to the user. When making a comparison of other producers' offerings, be certain these features are not overlooked.

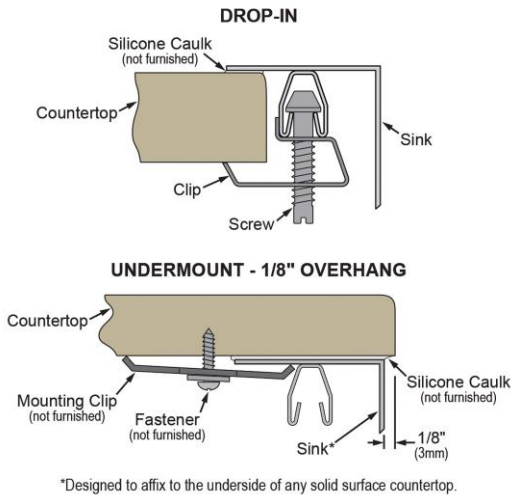

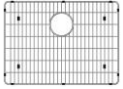

Installation Profile:

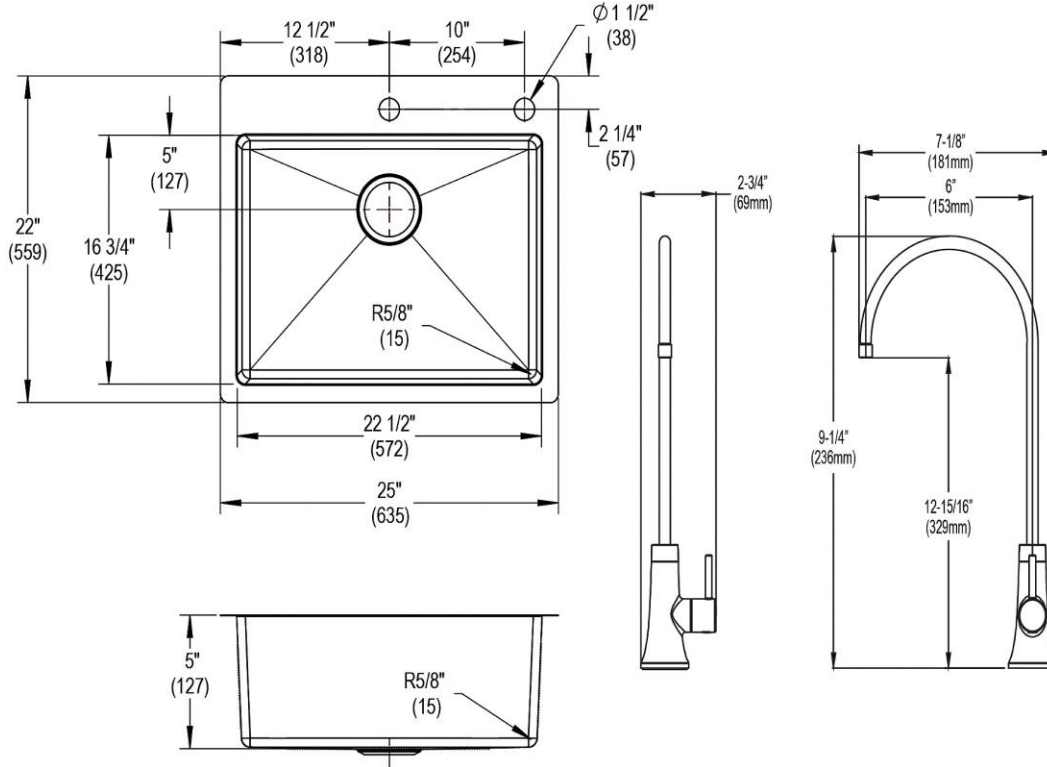

Included Accessories		
CTXBG2115	Elkay Crosstown Stainless Steel 21" x 15-1/4" x 1-1/4" Bottom Grid Spec Sheet (PDF)	
LKAV71FLS	Elkay Avado Single Lever Filtered Beverage Faucet Lustrous Steel Spec Sheet (PDF)	

In keeping with our policy of continuing product improvement, Elkay reserves the right to change product specifications without notice. Please visit elkay.com for the most current version of Elkay product specification sheets. This specification describes an Elkay product with design, quality, and functional benefits to the user. When making a comparison of other producers' offerings, be certain these features are not overlooked.



Optional Accessories		
LK99	Elkay Deluxe 3-1/2" Drain Type 304 Stainless Steel Body Strainer Basket Rubber Seal and Tailpiece Spec Sheet (PDF)	
LKAV3031LS	Elkay Avado Single Hole Kitchen Faucet with Pull-down Spray and Forward Only Lever Handle Lustrous Steel Spec Sheet (PDF)	
LKAV4061LS	Elkay Avado Single Hole Kitchen Faucet with Semi-professional Spout Forward Only Lever Handle Lustrous Steel Spec Sheet (PDF)	
LKEC2041LS	Elkay Explore Single Hole Kitchen Faucet with Pull-down Spray and Forward Only Lever Handle Lustrous Steel Spec Sheet (PDF)	
ERF750	Elkay 750-gallon Residential Replacement Filter Spec Sheet (PDF)	

In keeping with our policy of continuing product improvement, Elkay reserves the right to change product specifications without notice. Please visit elkay.com for the most current version of Elkay product specification sheets. This specification describes an Elkay product with design, quality, and functional benefits to the user. When making a comparison of other producers' offerings, be certain these features are not overlooked.