

WARNING

- * Switch off the main electrical supply from the main fuse box / circuit breaker before installation.
- * Inspect item carefully before attempting to install.
- * If there is any damages or obvious defects, do not install.
- * Item may not be returned once it has been installed.















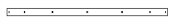

CARE AND MAINTENANCE

- * To clean the outside of the fixture, use a dry or slightly dampened clean cloth (use clean water, never a solvent) to wipe the surface of the fixture.
- * To clean the inside of the fixture, first disconnect power to the fixture by turning off the circuit breaker or by removing the fuse at the fuse box. Next, use a dry or slightly dampened clean cloth (use clean water, never a solvent) to wipe the interior surface of the fixture.
- * Do not use any cleaners with chemical, solvents or harsh abrasives. Use only a dry soft cloth to dust or wipe carefully.

NOTICE& IMPORTANT SAFETY INSTRUCTIONS

- ** WE RECOMMEND INSTALLATION OF THIS LIGHTING FIXTURE BE DONE BY A LICENSED ELECTRICIAN **
- * Please make sure that you have all parts indicated before you begin assembly of this item
- * This item should be assembled on a soft surface to prevent scratching the finish during assembly
- * To reduce the risk of fire, electrical shock or injury to persons or property, please follow the guideline below for safe use and installation
- *The external flexible cable or cord of this lamp cannot be replaced
If the cord is damaged, the lamp shall be destroyed

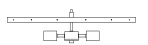
Part List and Hardware List

| PIECE | DESCRIPTION | PICTURE | QUANTITY | PIECE | DESCRIPTION | PICTURE | QUANTITY |
|-------|----------------|---|----------|-------|------------------|---|----------|
| A | Wire Connector |  | 3X | J | Nut |  | 4X |
| B | Mounting Plate |  | 1X | K | Bracket |  | 4X |
| C | Ground Screw |  | 1X | L | Ball Screw |  | 32X |
| D | Mounting Screw |  | 2X | M | Bottom Frame |  | 1X |
| E | Canopy |  | 1X | N | Bulb |  | 4X |
| F | Canopy Nut |  | 2X | O | Big Glass Dish |  | 14X |
| G | Short Stem |  | 2X | P | Small Glass Dish |  | 14X |
| H | Long Stem |  | 2X | Q | Rubber Washer |  | 28X |
| I | Lamp Body |  | 1X | | |  | |



Model#: CHA4064

Product Dimensions: 24"D X 15.5-45.5"H

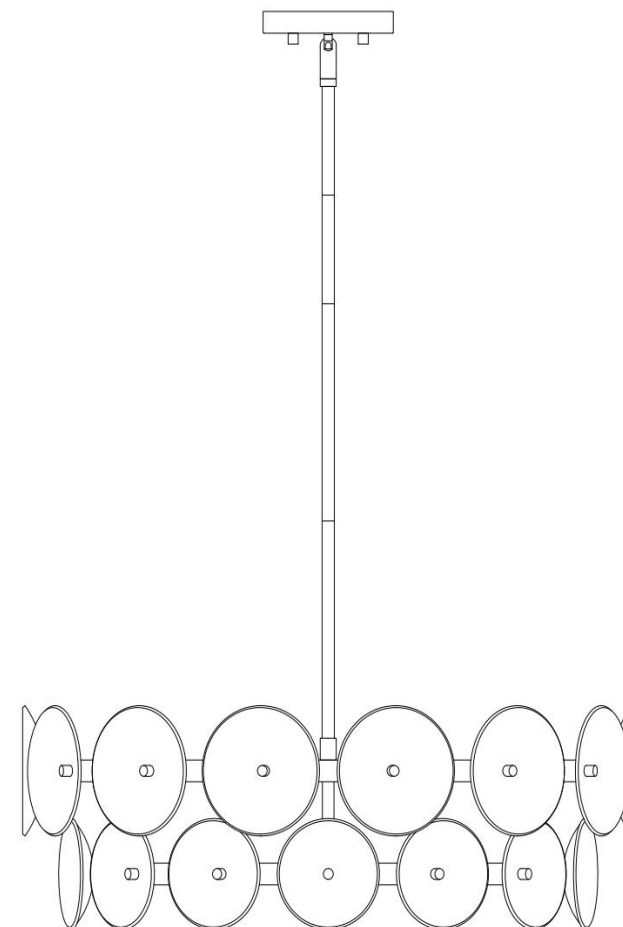

PREPARATION

- * Before beginning assembly of product, make sure all parts are present. Compare parts with package contents list and hardware contents list.
- * If any part is missing or damaged, do not attempt to assemble the product.
- * Estimated Assembly Time: 20 minutes.
- * If you are having difficulty, our friendly Customer Care team is always here to help. Please email customersupport@safavieh.com

NOTE: PLEASE USE TYPE "A" BULB MAX 40-WATT LED BULB MAX 9-WATT, THERE ARE 4PCS LED 4-WATT BULB IN THE BOX

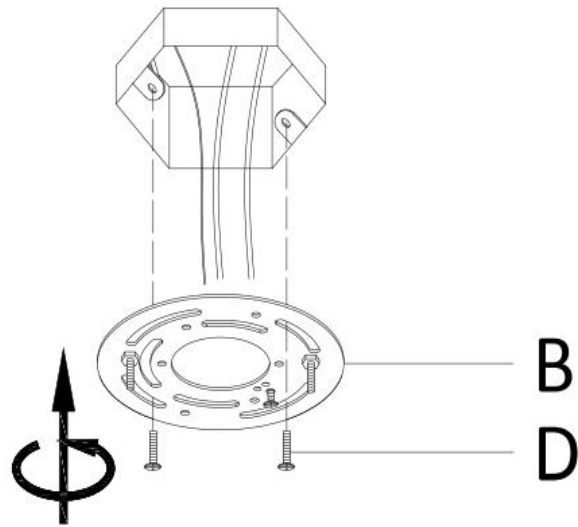

Step 1: Unpack all parts from cartons carefully. Separate the Mounting Plate (B) from the Canopy (E) by removing the Canopy Nut (F) anti-clockwise. Fix the Mounting Plate(B) to the junction box with Mounting Screw (D).

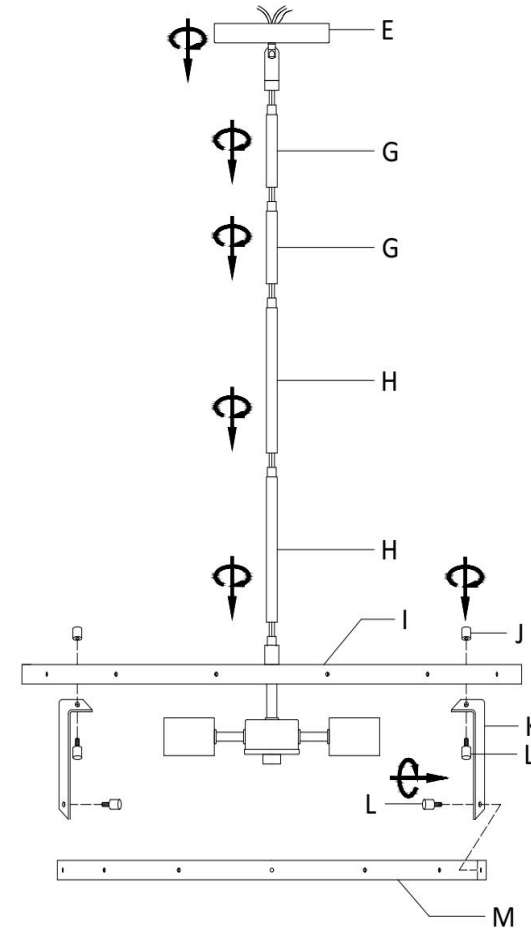

Step 2: Attach the Ball screws (L) to the Bracket (K) and Lamp Body (I), then secure with the Nut (J). Secure the the Bracket (K) to the Bottom Frame (M) with the Ball screws (L). Screw the Long Stem (H) and Short Stem (G) to the Lamp Body (I). Make sure to feed the branchwires of the fixture through the stems during assembly. Remove or add stems to adjust the height. Then screw the canopy (E) to the stem.

PREPARATION

- * Before beginning assembly of product, make sure all parts are present. Compare parts with package contents list and hardware contents list.
- * If any part is missing or damaged, do not attempt to assemble the product.
- * Estimated Assembly Time: 20 minutes.
- * If you are having difficulty, our friendly Customer Care team is always here to help. Please email customersupport@safavieh.com

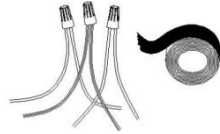
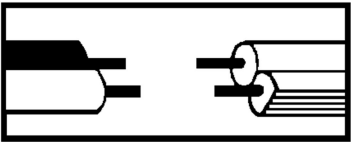

Step 3: Wire connection

Connect fixture neutral wire (ribbed) to the outlet box neutral wire (usually white) using a wire connector (A).

Connect fixture hot wire (smooth with markings) to the outlet box hot wire (usually black) using a wire connector (A).

CAUTION: Do not reverse the hot and neutral connections

Grounding Instructions:

Wrap ground wire from outlet box around green ground screw (C) on mounting bracket, no less than 2" from wire end. Tighten ground screw. If fixture is supplied with a ground wire, connect to outlet ground wire with a wire connector (A).

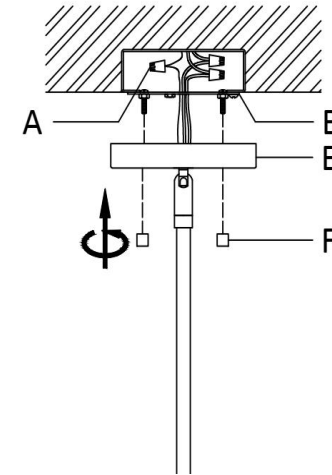

Step 4: Tuck wires inside junction box. Attach the Canopy (E) to the Mounting Plate (B), and secure with the Canopy Nut (F).

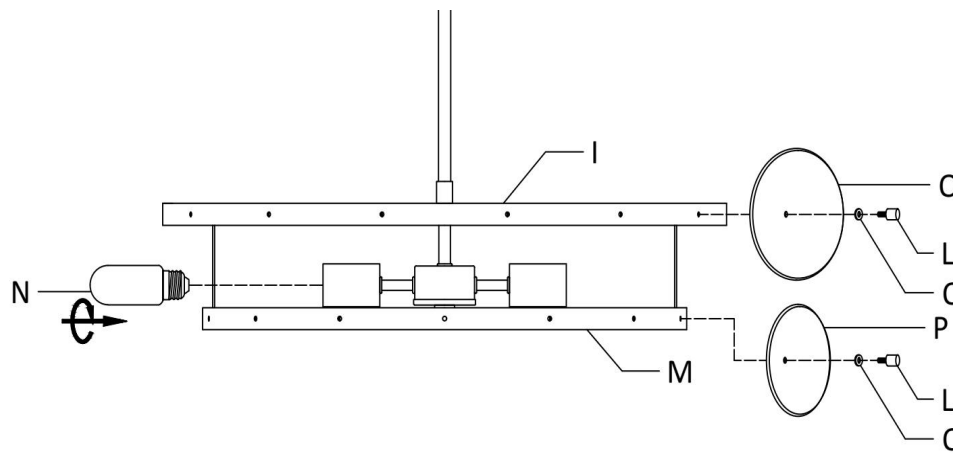

Step 5: Attach the Rubber Washed (Q) and Big Glass Dish (O) to the Lamp Body (I), then secure with the Ball Screws (L). Attach the Rubber Washed (Q) and Small Glass Dish (P) to the Bottom Frame (M), then secure with the Ball Screws (L). Insert the Bulbs (N) into the Socket.