

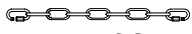







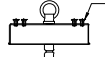

| | | | |
|---|--|---|--|
| ① | canopy 1PCS  | ⑩ | glass lampshade 4PCS |
| ③ | chain 1PCS  | ⑪ | hanging tube 1PCS  |
| ④ | ⑤ bolt screw 24PCS upper connected box 1PCS  | | X 1PCS  |
| ⑥ | down connected box 1PCS  | | X 3PCS  |
| ⑦ | metal profile 6PCS  | | X 3PCS  |
| ⑧ | lighting fixture 1PCS  | | X 3PCS  |
| | | | X 2PCS  |

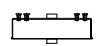

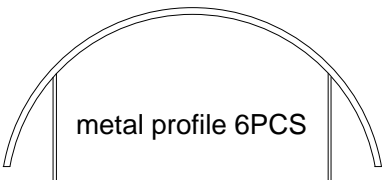
1. Install the metal profile ⑦ to up and down box with bolt screw ⑤.
2. Upward the light arm 90 degree and adjust the light arms to suitable position like picture shown,
3. Let the wire of the fixture go through the hanging tube ⑪, rotate to install the tube ⑪ to the fixture, let the wire go through the box ④, rotate to fix both parts together.

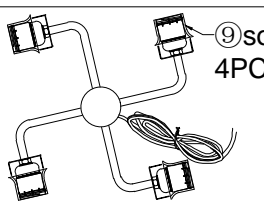

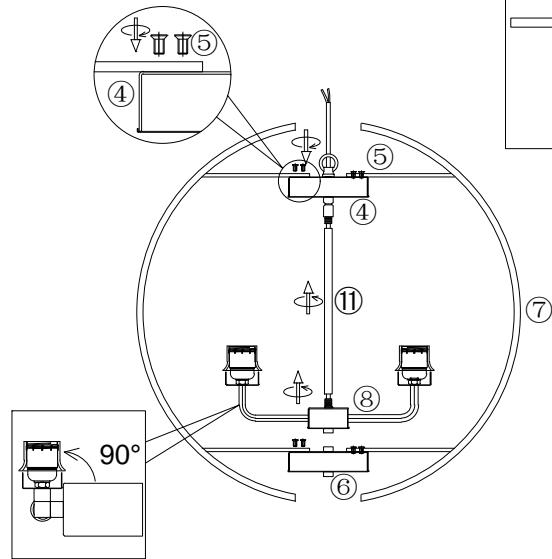
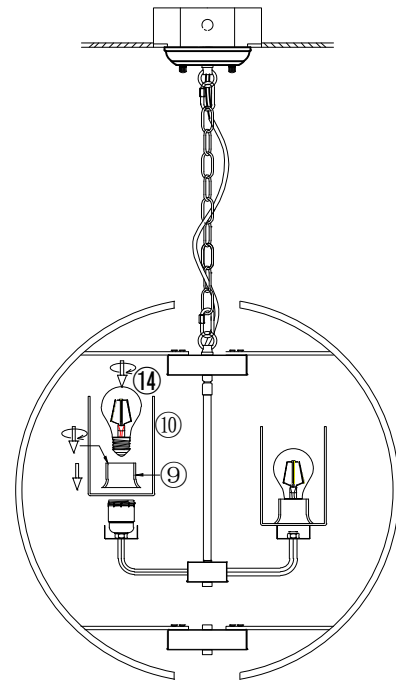
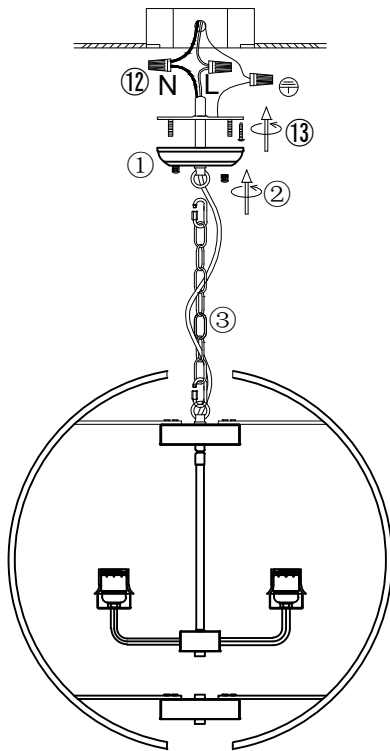
Please operate with gloves to avoid leaving stains on the lampshade.

4. Hang the fixture to the canopy ① with chain ③, let the wire go through the chain ③ and canopy ①.
5. Install the bracket to the ceiling junction box with screws ⑬.
6. Connect the wire to the home line with cap connectors ⑫.
7. Install the fixture to the bracket with cap nuts ②.

8. Rotate to remove out the socket ring ⑨ from the bulb holder, install the lampshade ⑩ to the bulb holder with socket ring ⑨.
9. Install the bulb ⑭.

Please read carefully before installation!!!

Note : Please make sure that the electricity is powered off during installation !

Only a professional electrician should install this kind of product !