

USER MANUAL

Electric Fireplace

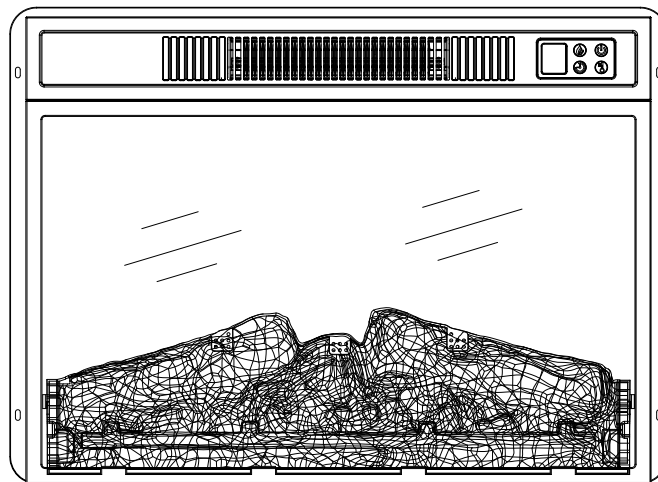

THIS INSTRUCTION BOOKLET CONTAINS IMPORTANT SAFETY INFORMATION.
PLEASE READ AND KEEP FOR FUTURE REFERENCE.

Table of Contents

Safety Information.....	3
Pre-installation.....	6
Assembly.....	7
Operation.....	8
Using the Remote Control.....	11
Care and Maintenance.....	12
Troubleshooting.....	13

Safety Information

IMPORTANT SAFETY INFORMATION

PLEASE READ ALL OF THE INFORMATION IN THIS OPERATING MANUAL, INCLUDING ALL SAFETY, OPERATING, AND MAINTENANCE INFORMATION. TO AVOID THE POTENTIAL RISK OF FIRE, ELECTRIC SHOCK, OR INJURY TO PERSONS, USERS SHOULD FOLLOW THE DIRECTIONS AND WARNINGS IN THIS MANUAL

1. Read all instructions before using this heater.
2. Do not use this heater outdoors.
3. This heater is not intended for use in bathrooms, laundry areas and similar indoor locations. Never locate the heater where it may fall into a bathtub or other water container.
4. Do not run the power cord under carpeting. Do not cover the power cord with throw rugs, runners, or the like. Arrange the power cord away from traffic areas and where it will not be tripped over.
5. To disconnect the heater, turn controls to off, then remove the plug from the outlet.
6. Connect to properly grounded outlets only. Always plug heaters directly into a wall outlet/receptacle. Never use with an extension cord or relocatable power tap (outlet/power strip).
7. To prevent a possible fire, do not block firebox air intakes or the exhaust in any manner. Do not operate the firebox on soft surfaces, like a bed, where openings may become blocked.
8. There is a thermostat limiter inside the heater. When the inner temperature over heats or abnormal heating occurs, the thermostat protective device cuts off the power supply to avoid fireplace damaged or risk of fire.
9. Use this heater only as described in this manual. Any other use not recommended by the manufacturer may cause fire, electrical shock, or injury to persons.

SAVE THESE INSTRUCTIONS



WARNING

There are no user serviceable parts inside the fireplace/heater. If the unit appears to malfunction, turn the unit off and unplug the unit from the wall immediately, and contact Customer.



WARNING

This heater is hot when in use. To avoid burns, do not let bare skin touch hot surfaces. If provided, use handles when moving this heater. Keep combustible material, such as furniture, pillows, bedding, papers, clothes and curtains at least 3 f.t.(0.9 meters) from the front of the heater and keep them away from the sides and rear.



WARNING

Extreme caution is necessary when any heater is used by or near children or invalids and whenever the heater is left operating and unattended.



WARNING

Always unplug the heater when not in use.



WARNING

Do not operate any heater with a damaged cord or plug or after the heater malfunctions, has been dropped or damaged in any manner. Return the heater to an authorized service facility for examination, electrical or mechanical adjustment, or repair.



WARNING

Do not insert or allow foreign objects to enter any ventilation or exhaust openings as this may cause an electric shock or fire, or damage the heater.



WARNING

A heater has hot and arching or sparking parts inside. Do not use in areas where gasoline, paint, or flammable liquids are used or stored.



CAUTION

While the heater is in use, the top center of the fireplace can get hot to the touch, and may cause serious injury or burns. Always supervise small children around the fireplace/heater. Do not place any cloth or decorations over the heater outlet of the fireplace, or otherwise obstruct the heater outlet of the fireplace, as this may cause a fire and serious injury may result,

Safety Information (continued)

GROUNDING INSTRUCTIONS



DANGER

Improper connection of the equipment-grounding conductor can result in a risk of electric shock. Check with a qualified electrician or serviceman if you are in doubt as to whether the product is properly grounded. Do not modify the plug provided with the product. If it will not fit the outlet, have a proper outlet installed by a qualified electrician.

This product must be grounded. If it should malfunction or breakdown, grounding provides a path of least resistance for electric current to reduce the risk of electric shock. This product is equipped with a cord having an equipment-grounding conductor and a grounding plug. The plug must be plugged into an appropriate outlet that is properly installed and grounded in accordance with all local codes and ordinances.

This heater is for use on 120-volt circuits and has a grounded plug. An adapter is available from your local electronics store or online supplier for connecting three-blade grounding-type plugs to two-slot receptacles. The green grounding lug extending from the adapter must be connected to a permanent ground such as a properly grounded outlet box. The adapter should not be used if a three-slot grounded receptacle is available.

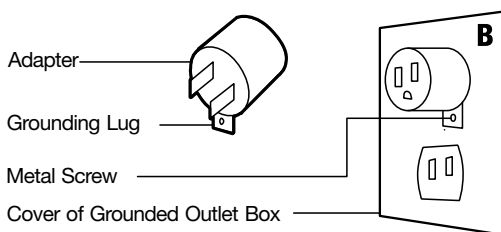
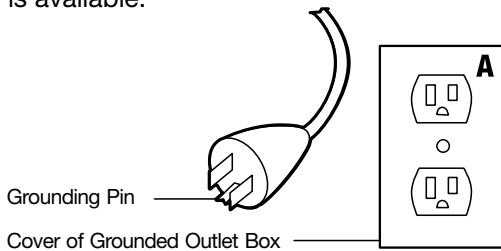

Pre-installation

TECHNICAL SPECIFICATION

Model Number	Description
Dimensions(WxDxH)	24.2"x5.1"x17.5"
Net Weight	12.6 lb
Gross Weight	14.8 lb
Power Rating	1400W
Voltage	120V
Frequency	60Hz

PACKAGE CONTENT

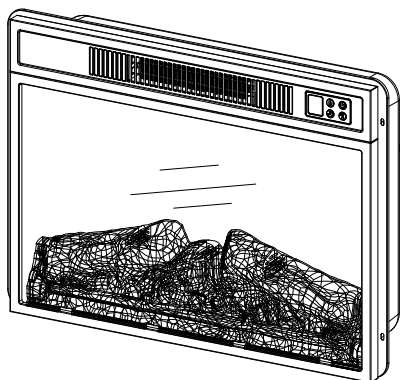

Fireplace Unit

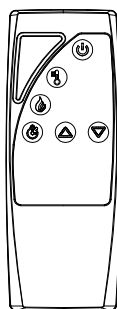

Remote Control

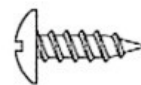

Screw x5

Assembly

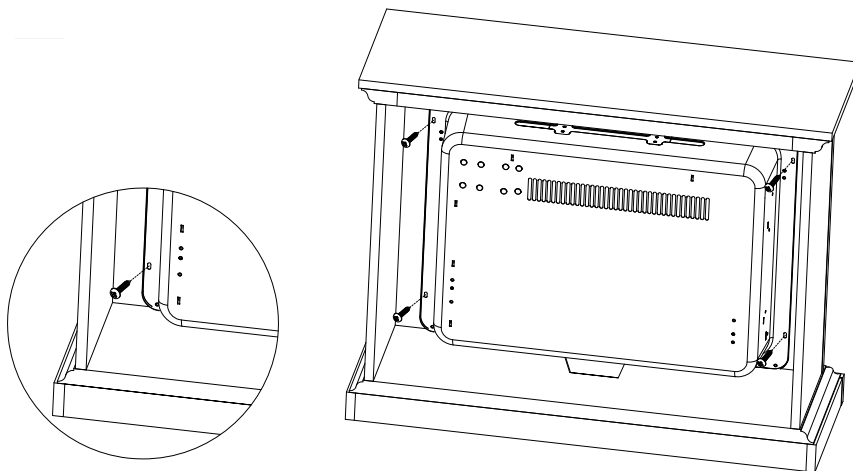

● STEP 1

Take out the unit from the box and layout all the spare parts for easy assembly. Make sure all small items are not left in packaging materials.

● STEP 2

Carefully set the unit from the back of the mantel and center it in the opening. Check the alignment and attach the unit of the mantel by inserting screws through the drilled holes on the trim of the mantel.

NOTE:

Do not attempt to install the unit from the front of the mantel. It will not fit.

Operation

● Identifying the control panel

- The control panel is located on the top right corner of the fireplace/heater unit.
- The control panel contains the display unit (1), function indicator (2), timer function (3), heater control (4), flames control (5), and main power(6).
- The display unit (1) displays information about the flame level,timer, and current temperature.

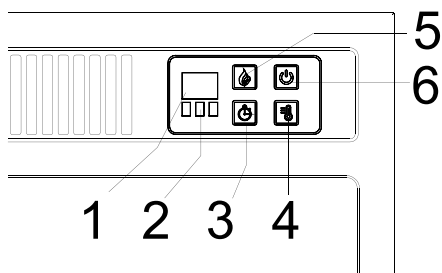

● Understanding the function indicator

- The function indicator (2) has three square LEDs -red, green,and blue.The red LED indicates that the Fahrenheit temperature heating function is running, the green LED indicates that the Celsius temperature heating function is running, and the blue LED indicates that the timer function is engaged.
- To the bottom of the three LEDs, is the infrared receiver module which communicates with the remote control to control the heater.

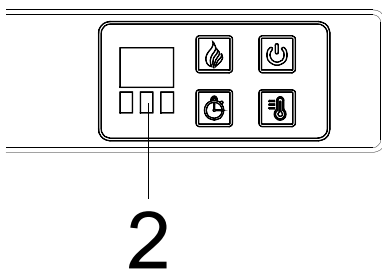

Operation

● Using the timer function

The timer button (3) allows you to set the amount of time you want the fireplace/heater to run. The timer button (3) operates both the flames and the heater function. If the heater is operating when the timer is set, then the heater is on the timer. If the flames are operating, then the timer will control the flames. If both the heater and flames are operating with the timer set, then the timer controls both the flames and the heater. Pressing the button in sequence will set the timer for a set interval. This interval period is shown in the display (1), in blue. The set intervals are displayed in this table. The timer interval is set from the time the interval is selected. There is no clock function for turning the heater or flames on or off at a specific time.

Button Press	Timer Interval	Display
1st press	30 Minutes	30
2nd press	1 Hour	1h
3rd press	2 Hours	2h
4th press	3 Hours	3h
5th press	4 Hours	4h
6th press	5 Hours	5h
7th press	6 Hours	6h
8th press	OFF	None

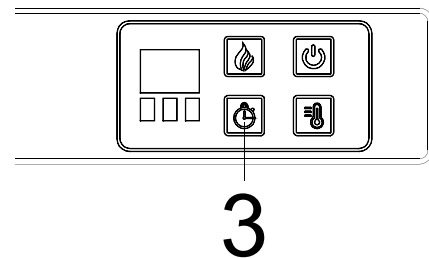

● Using the heater control

- The heater button (4) turns the heater on or off. There is no speed setting for the heater blower. If you put the heater in a standby mode (turn off by the main power button 6), the unit will hold the settings in the memory. When the power is turned back on, the heater will turn on at the same settings.
- When the heating function turns on, press and hold the heater button (4) for five seconds to enter temperature adjustment mode. The LED indicator is red. In adjustment mode, the display unit (1) flashes (interval is 0.5 second). There are 22 levels to change Fahrenheit temperature 72°F – 73°F...82°F – ON – 62F – 63F ...71 F. After this is set, the display (1) will flash five times and exit from setting status. If idle, the display turns off after 10 seconds.
- With the heater on, gently press and hold the main power button for five seconds to enter temperature converting mode. The LED indicator flashes five times in red color then changes to green. In this converting mode, the display (1) flashes (interval is 0.5 second). Press and hold the heater button (4) for five seconds to enter temperature adjustment mode. There are 12 levels to change Celsius temperature 22C – 23°C ...27°C – ON – 17C – 18..21C. After it is set, the display (1) flashes five times. If idle, the display turns off after 10 seconds. Repeat the same process to convert Celsius temperature into Fahrenheit temperature.

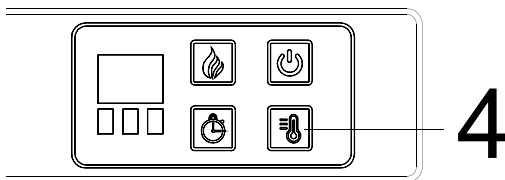

Operation

● Using the flame control

•Press the flame button (5) to set the flames for different levels of flame height. These flame levels are shown in the display (1).The flame settings are as follows:

Button Press	Flame Level	Display value	Fireplace Appearance
1st press	High	L3	Flames Highest, Logs Glow Highest
2nd press	Medium	L2	Flames Medium, Logs Glow Medium
3rd press	Low	L1	Flames Low, Logs Glow Low
4th press	All Off	None	Flames Off, Logs off

•Regardless of the previous flame setting, when powered off by the main power button(6), the flames will come on in L3 mode(High)when you turn the heater on.

•When the heater function turns on, the flame level will cycle through the 3 different level settings continuously.

Button Press	Flame Level	Display value	Fireplace Appearance
1st press	High	L3	Flames Highest, Logs Glow Highest
2nd press	Medium	L2	Flames Medium, Logs Glow Medium
3rd press	Low	L1	Flames Low, Logs Glow Low

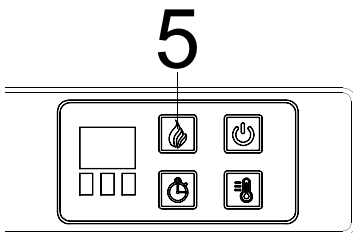

● Using the main power button

•Press the power button(6) to turn the fireplace/heater unit on and off. Press the power button (6) once to turn the unit on.Press again to turn the unit off.

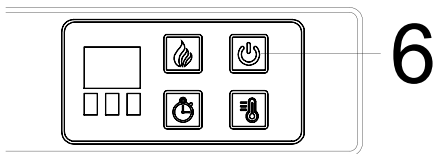

Using the Remote Control

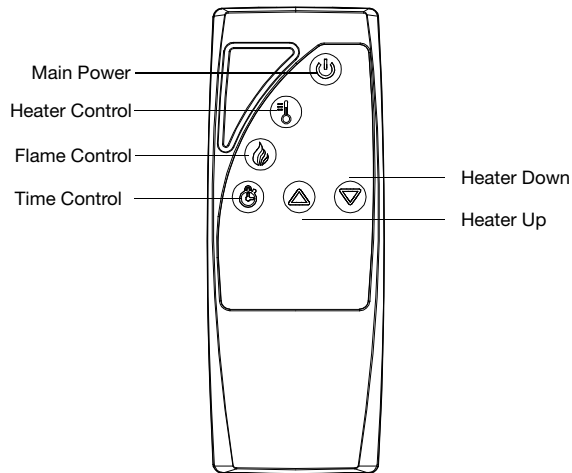

● Using the Remote control

The operation of the remote control buttons work the same as button on the control panel.

NOTE:

The remote control cannot be used to switch between degree Fahrenheit and degree Celsius.

● Install the battery

For replacement batteries, use AAA batteries.

Press down and slide back cover off the battery compartment.

Insert two provided AAA batteries into the battery compartment making sure that the ends of the batteries with the negative(-) symbols are against the springs in the battery compartment.

Replace the battery compartment cover, making sure it snaps into position.



WARNING

Do not ingest batteries.

1. Non-rechargeable batteries are not to be recharged.
2. Batteries are to be inserted with the correct polarity.
3. Exhausted batteries are to be removed from the product.
4. Always purchase the correct size and grade of battery most suitable for the intended use.
5. Replace all batteries of a set at the same time. .
6. Clean the battery contacts and also those of the device prior to battery installation.
7. Remove batteries from equipment when not used for an extended period of time.



NOTE:

Battery disposal
Please always dispose
of batteries at a suitable
recycling point.



Care and Maintenance

WARNING

Always disconnect from the power supply before cleaning the heater.
First turn off the main power.
Then remove the electrical plug from the wall outlet.

WARNING

Do not use this fireplace insert if any part of it has been under water.
Immediately call a qualified service technician to inspect the firebox and
replace any part of the electrical system which has been underwater.

The blower motor and flame motor are pre-lubricated for a durable using time and need no further lubrication or maintenance. To remove any accumulation of dust or debris, the soft brush attachment of a vacuum cleaner should occasionally be used to clean the outlet grille of the fan heater.

- Use a soft, clean cloth that will not scratch the surface when dusting.
- Use a clean soft cloth dampened with warm water to clean the fireplace surface.
DO NOT use household or abrasive cleaners, as these products may damage the surface.
- When cleaning the glass viewing screen use a non-abrasive damp cloth with liquid cleaner or soft soap if necessary; Don NOT use cleaning powders or any other substance with abrasives since these substances will scratch glass.
- Under no circumstances should this product be operated with a broken or chipped glass panel.
- Do not strike or slam the glass.
- In the event that your appliance is stained or otherwise damaged during use, we recommend that you call a professional to it.
- When not in use please unplug the cord from the outlet to prevent any damage or accidents.

Troubleshooting

Problem	Solution
The unit does not turn on.	Check that the unit is fully plugged into a standard 120 V outlet. Press the power button on the control panel.
The unit is on, but there is no flame effect.	Open the back panels to check if the flame spindle has fallen off from the spindle motor.
There is a visible flame effect, but the heater does not continue to blow warm air after repeatedly turning on the heater.	Turn on/off the heater button several times to make sure it is in the "ON" position.
The heater does not work, but the power and heater switches are in the "ON" position.	Turn all switches to the "OFF" position and unplug the unit from the wall outlet for 5 minutes. After 5 minutes plug the unit back into the wall outlet, and operate as normal. Make sure that no objects are blocking the air vents on the top and on the front of your fireplace .
Remote control is not working.	Change the remote battery. Operate remote transmitter at a slow measured pace. Press the remote control buttons with an even motion and gentle pressure. Repeatedly pressing buttons in rapid succession may cause the transmitter to malfunction. Stand closer to your fireplace. Remove objects that may block your remote control's ability to communicate with your fireplace.