

CROSS

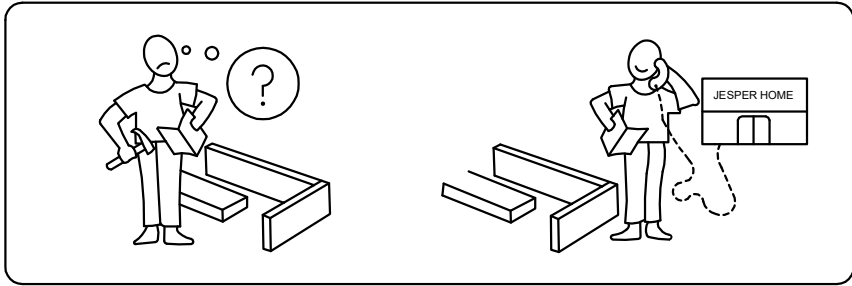

PLEASE MAKE SURE ALL PARTS ARE INCLUDED

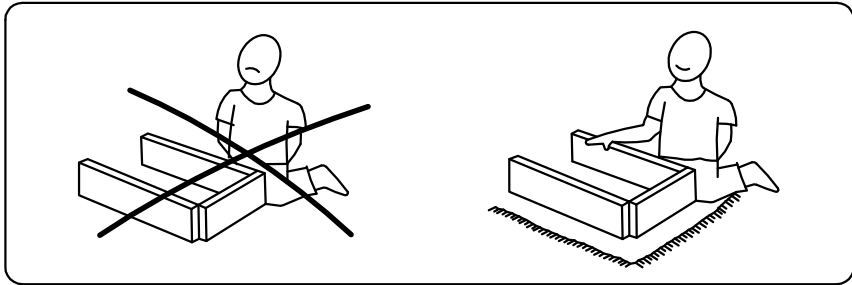
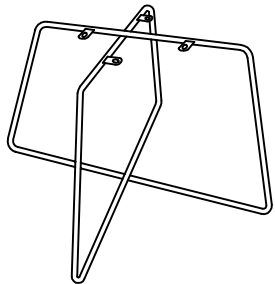

Leg x1

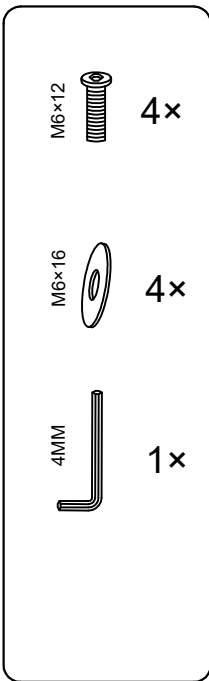

STEP-1

A POSITION

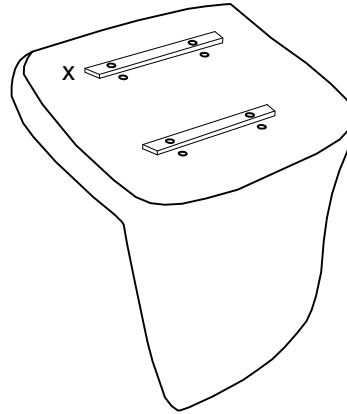

B POSITION

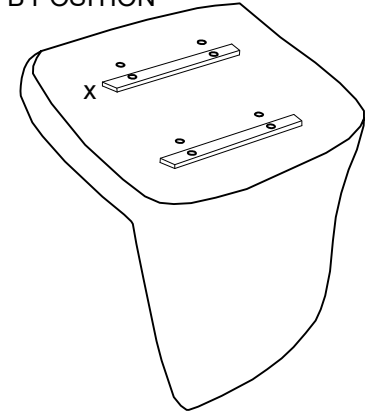

LEG WITH A POSITION

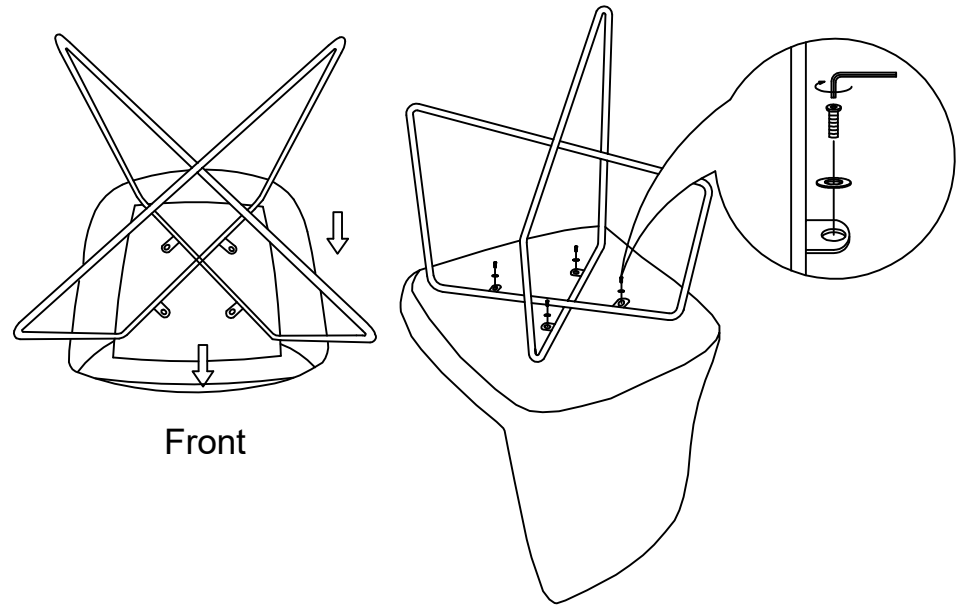

Front