

---

# ASSEMBLY MANUAL

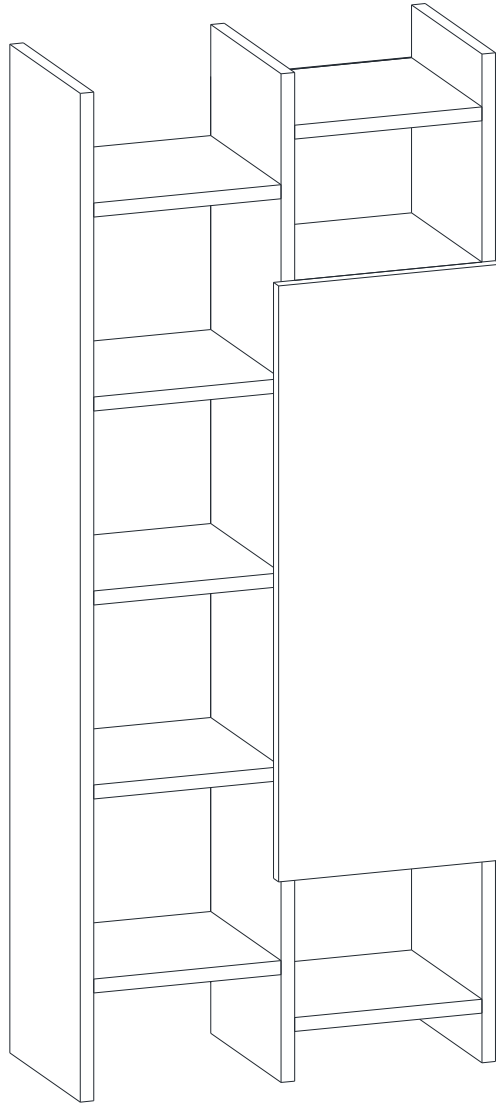

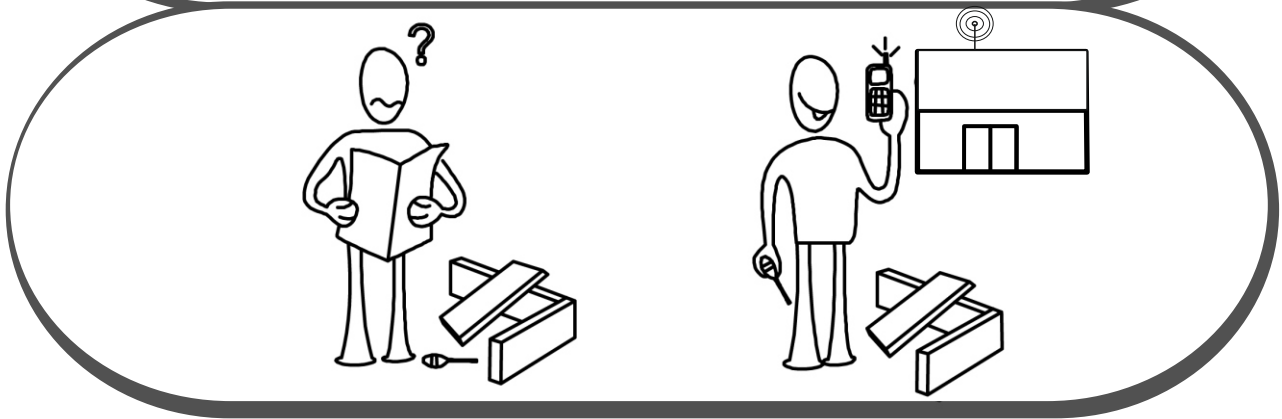
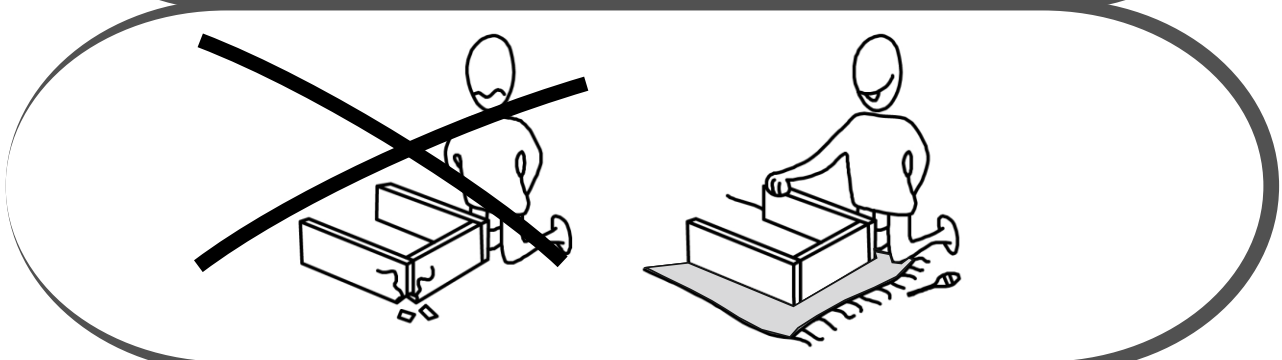
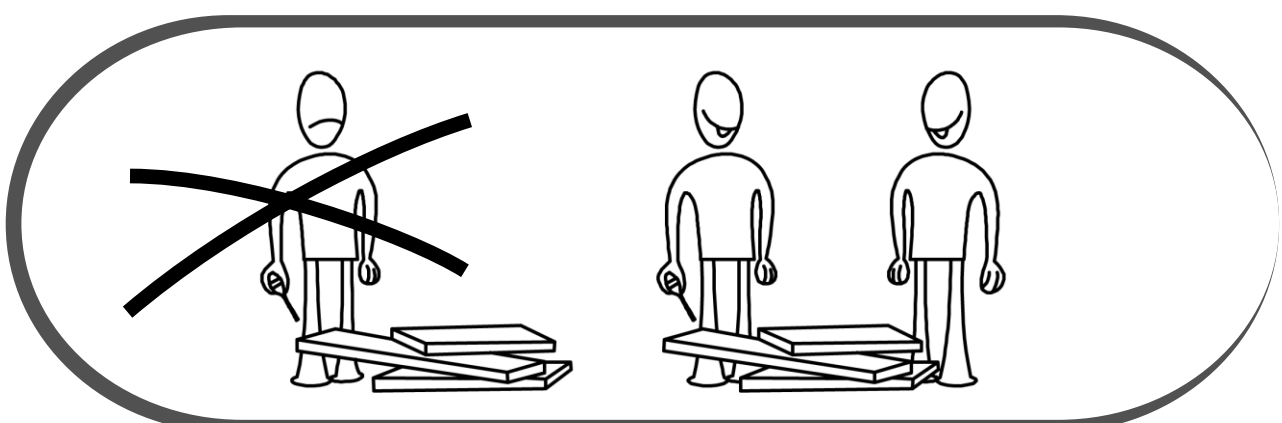

Dear Customer,

The product you bought was subjected to all sorts of tests and control before sending out to you. Even in this situation, sometimes happen that some component is damaged during the transportation. In such case please do not send the whole article back to us. Just request/order the damaged part. While requesting the required part, describe it exactly by looking to service card. Missing part will be sent to you as soon as possible. Before start assembling, please check the whole components and accessories according to the lists. After being sure that every part and accessory are okay and right, start assembling. Before start assembling, please clean all the components with a damp cloth. If you bought more than one product, to prevent confusion be sure that you completed the first product. Then start the other product's assembling. Never draw the products. While carrying, disassociate and lift the product and carry with minimum 2 people. For long distances carry the product with the package.

It is very easy to clean the surfaces of your product. It is enough to wipe with a damp and soapy cloth or other household cleaners. Do not directly contact your furniture with excessive heat, cold and humidity because the product can be affected.

# ATTENTION!!

Minifix is the main connection material used in our products. Before starting assembly, please check the drawings below...

Minifix Body

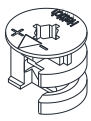

Minifix





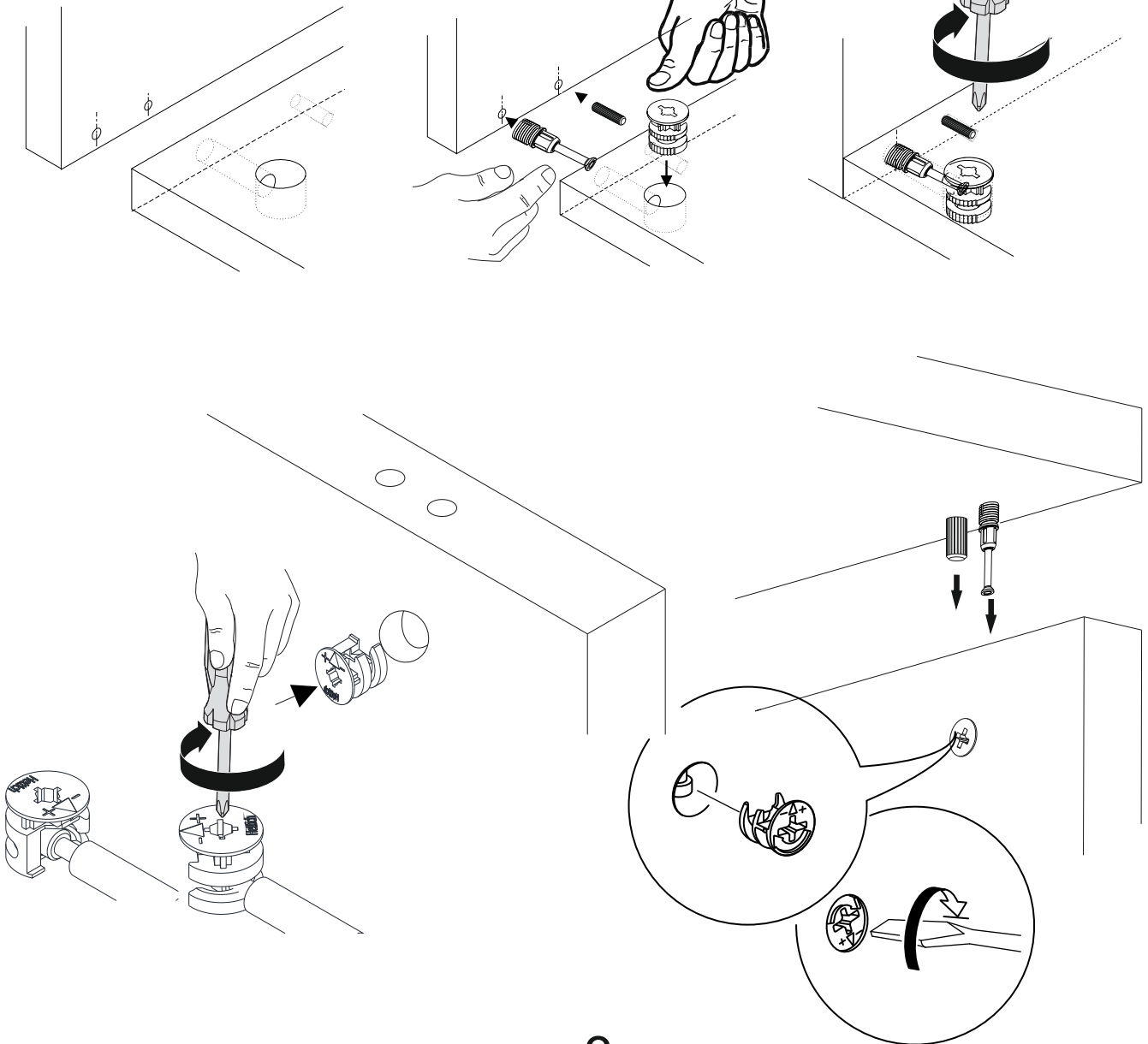
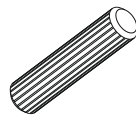

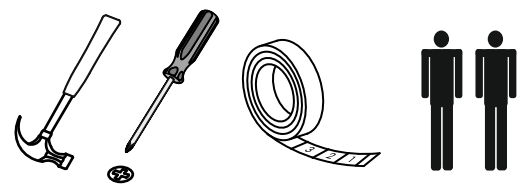
Dowel



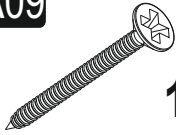

The necessary tools (not included)

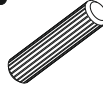
## ACCESSORY LIST

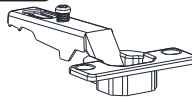
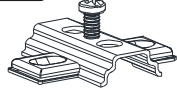
<b>A09</b>  4x50 <b>16x</b>	<b>A10</b>  3,5x18 <b>8x</b>	<b>A03</b>  <b>28x</b>	<b>A16</b>  <b>A 16x</b>	<b>A28</b>  <b>30x</b>
<b>A12</b>  <b>2x</b>	<b>A13</b>  <b>2x</b>			

## GENERAL VIEW

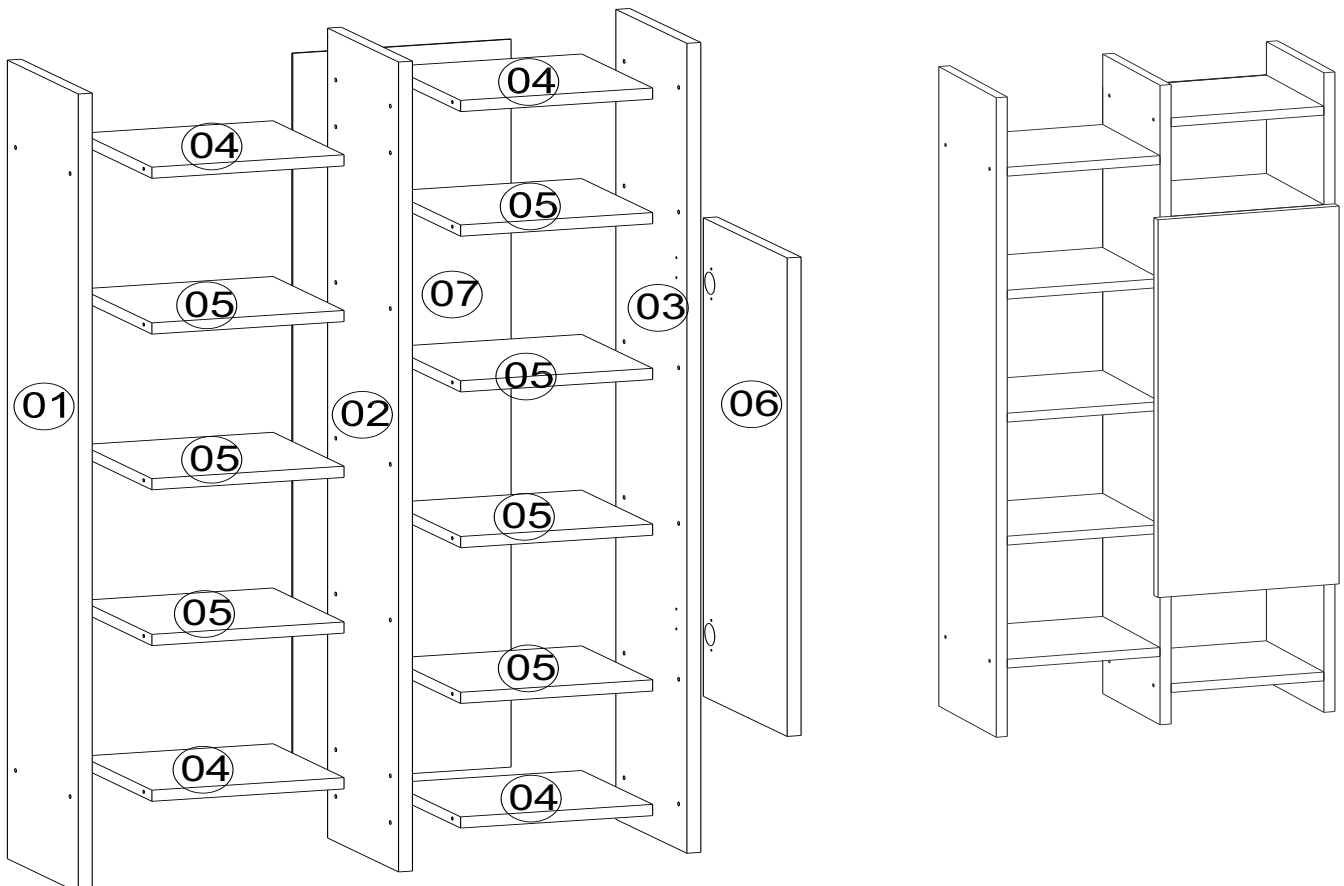

# ASSEMBLY MANUAL

# 1

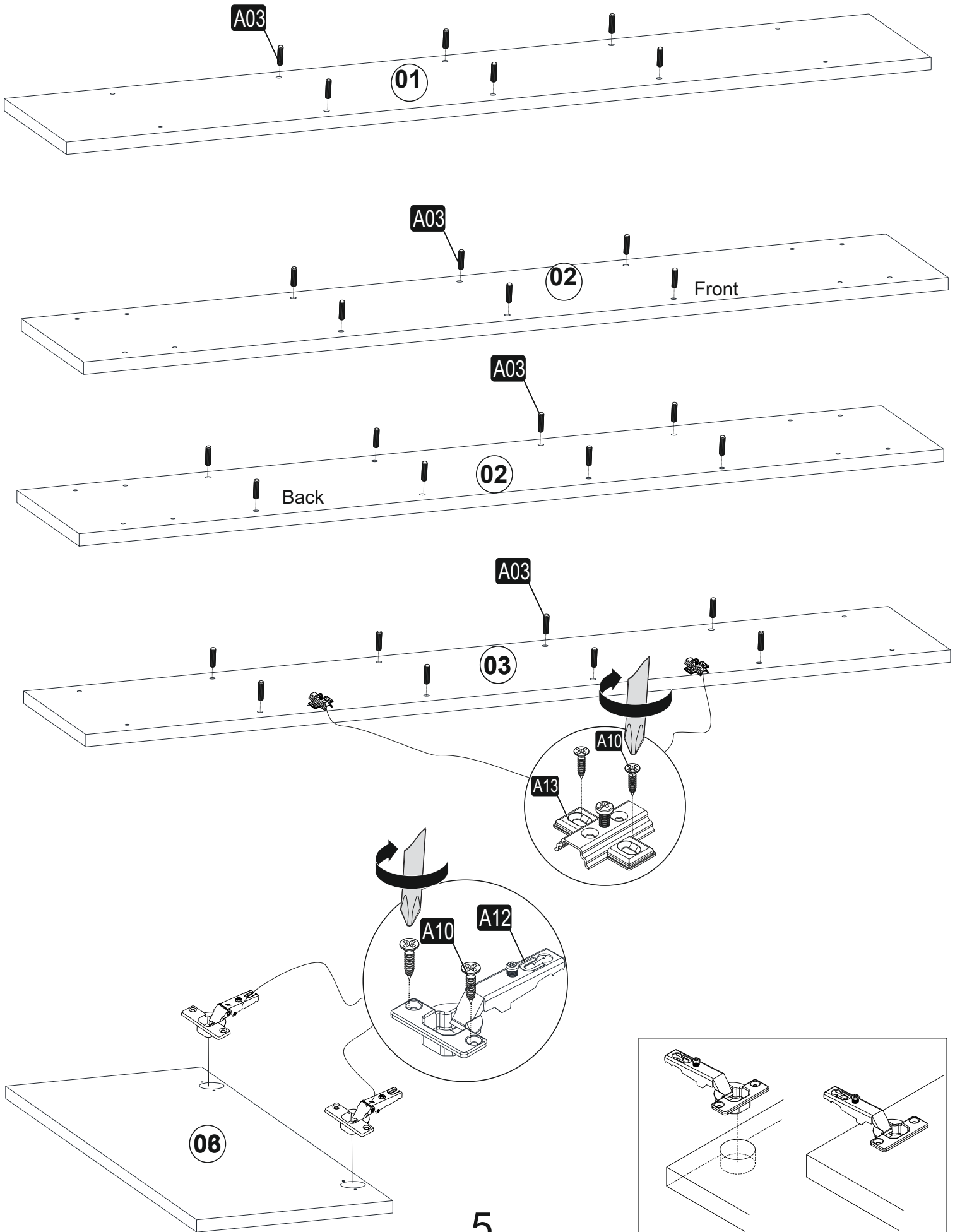

2

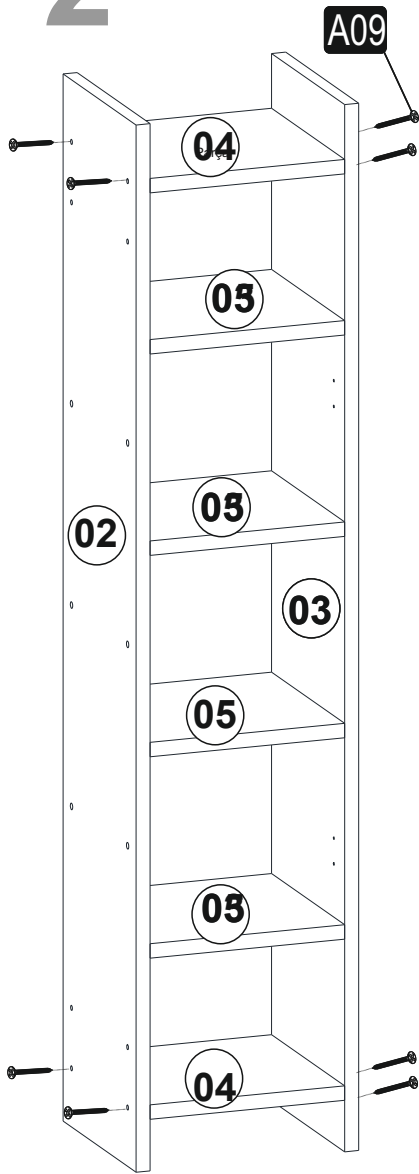

3

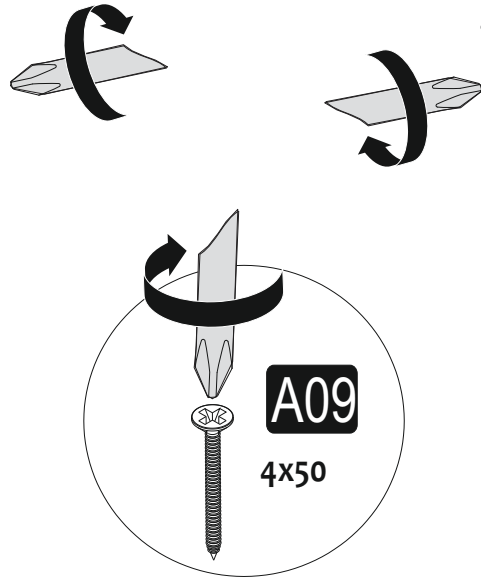
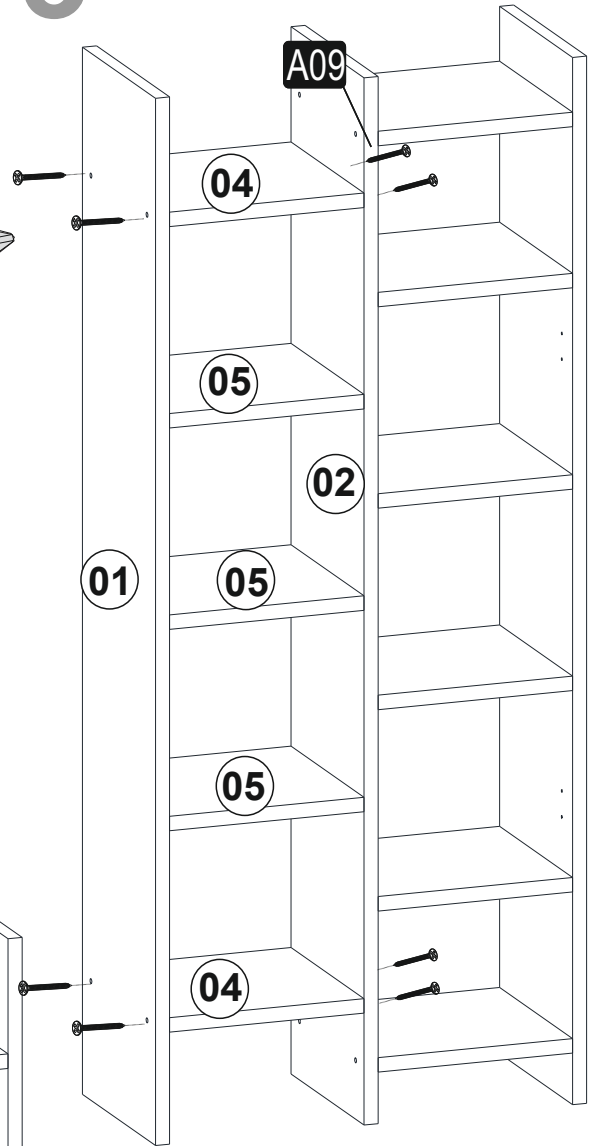

4

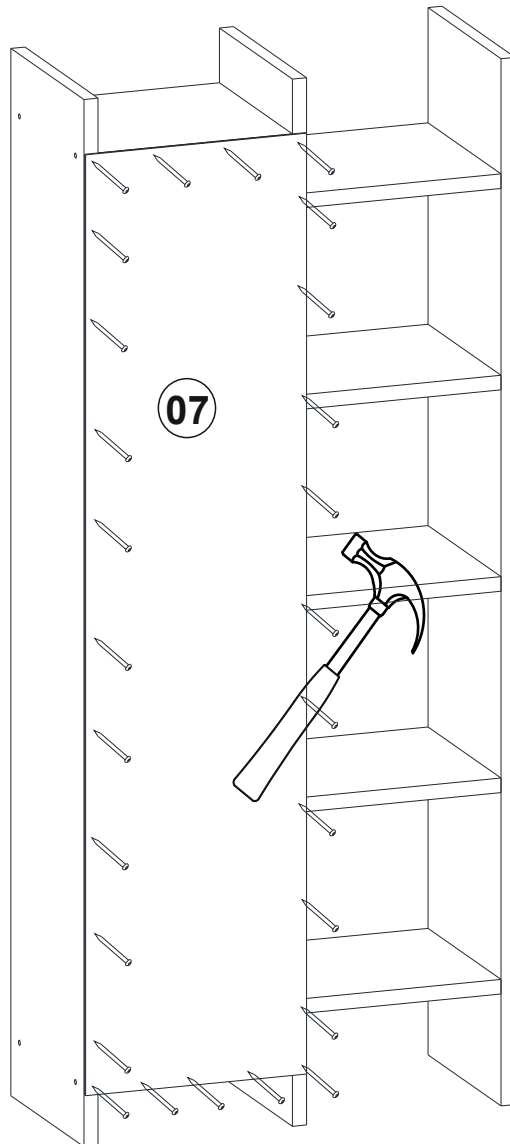

6

# 5

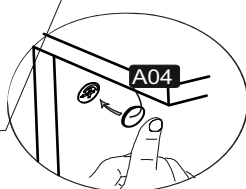
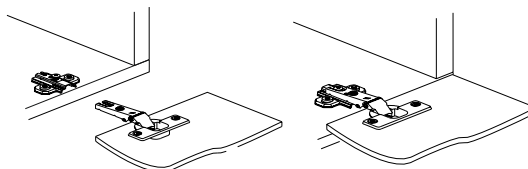
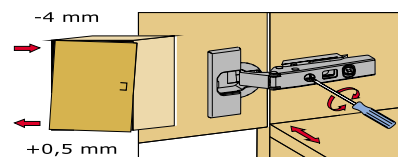
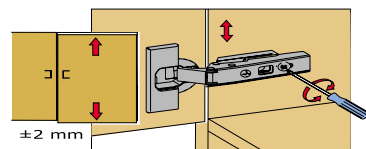
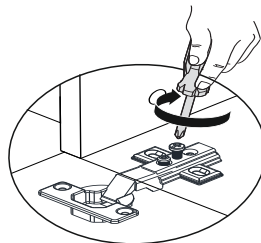
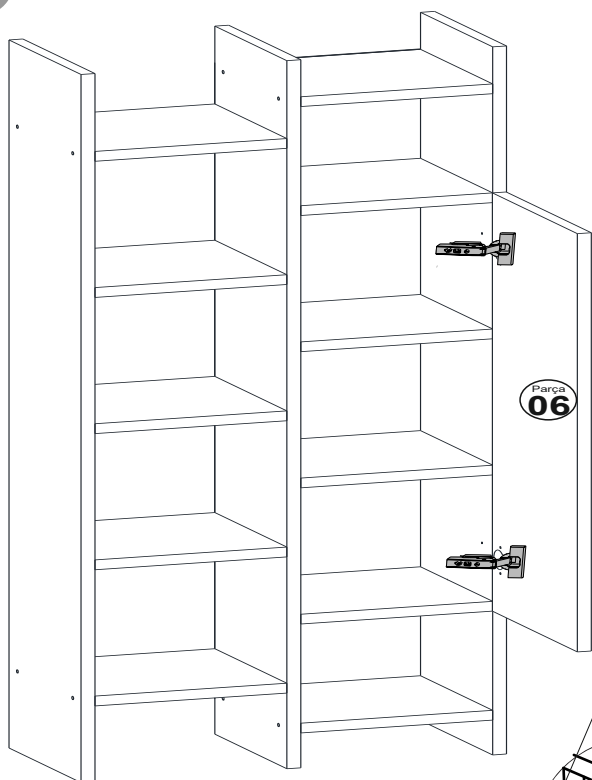

# 6

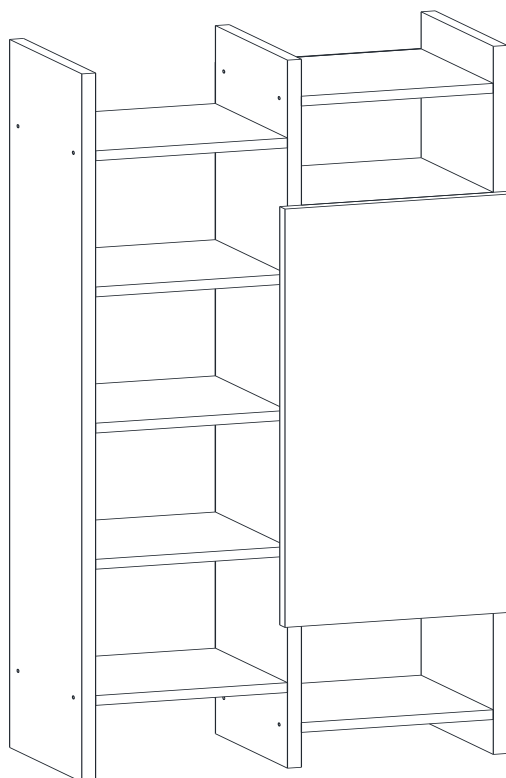

# 7



# **WARNING**

## **CHOKING HAZARD**

- This unit contains small parts which could be a choking hazard for small children. Children should be under adult supervision at all times.
- Do not overload the unit. Each shelf has a recommended capacity of 13 pounds, and the total weight on the unit should not exceed 39 pounds for wall shelves.
- Do not climb, step, or stand on the unit.
- Do not mount or attach items to the front, rear, or sides of the unit. This can cause the unit to become unbalanced and fall.
- Do not stack units.
- All units must be secured individually to wall studs using hardware provided. If wall studs are not accessible, consult your local hardware store for appropriate mounting hardware.
- We recommend you hand-tighten screws. Use care not to overtighten if using power tools. Follow proper safety procedures if using power tools and/or ladders.
- We recommend you protect your work surface during assembly to prevent scratching or damage to tabletops, wood floors, etc.
- Failure to follow the instructions listed here could result in bodily injury or damage to personal belongings. Use caution and follow safety procedures.