

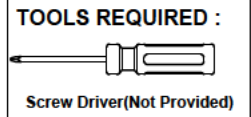

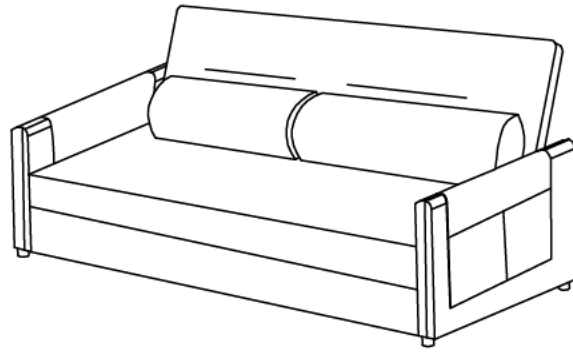

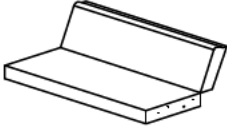

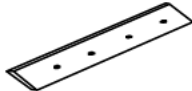





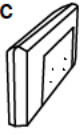

# ASSEMBLY INSTRUCTION











BLACK/GREY/GREEN



## Component

<p><b>A</b></p>  <p>Seat Base 1pc</p>	<p><b>B 1pc</b></p>  <p>Sleeper front panel</p>	<p><b>C</b></p>  <p>Back Panel 1pc</p>	<p><b>D 1pc</b></p>  <p>Sleeper cushion Top</p>	<p><b>P 1pc</b></p>  <p>Sleeper sliding frame</p>	
<p><b>E 1pc</b></p>  <p>Right Armrest</p>	<p><b>F 1pc</b></p>  <p>Left Armrest</p>	<p><b>M 1pc</b></p>  <p>Right Connector</p>	<p><b>N 1pc</b></p>  <p>Left Connector</p>	<p><b>J</b></p>  <p>Pillow 2pcs</p>	<p><b>S</b></p>  <p>Arm Bag 2pcs</p>
<p><b>G</b></p>  <p>Leg 4pcs</p>	<p><b>H 4pcs</b></p>  <p>Big Wheel</p>	<p><b>K 2pcs</b></p>  <p>Small Wheel L</p>	<p><b>Q 2pcs</b></p>  <p>Small Wheel R</p>	<p><b>R</b></p>  <p>L Plate 2pcs</p>	

## Hardware

1		Screw # 3/4"	16pcs	6		Hang Bolt	8pcs
2		Nut M8*16	8pcs	7		M6*35mm Bolt	16pcs
3		M6*45mm Bolt	4pcs	8		Allen Wrench	2pcs
4		M8*24 Flat washer	8pcs	9		M6*16 Flat washer	4pcs
5		Wrench	1pc	10		M6*20mm Bolt	4pcs

\*\* Place all parts on a clean and smooth surface such as a rug or carpet to avoid the parts from being scratched.

\*\*Before you begin , please review the assembly instructions step by step.

### Return & Warranty policy:

- We strive to offer the highest quality products. We also provide positive solutions with replacements or refund if needed.
- If the item is damaged or defective, please take photos to show the problem and email to the seller.
- Please do not return back the products before contact the seller.

- STEP 1**
1. Insert Legs (G) into the bottom of Armrest (E F) by turning.
  2. Assemble L plate (R) and small wheel(K Q) on armrest (E F).
  3. Attach arm bag (S) on arm rest (E F) .

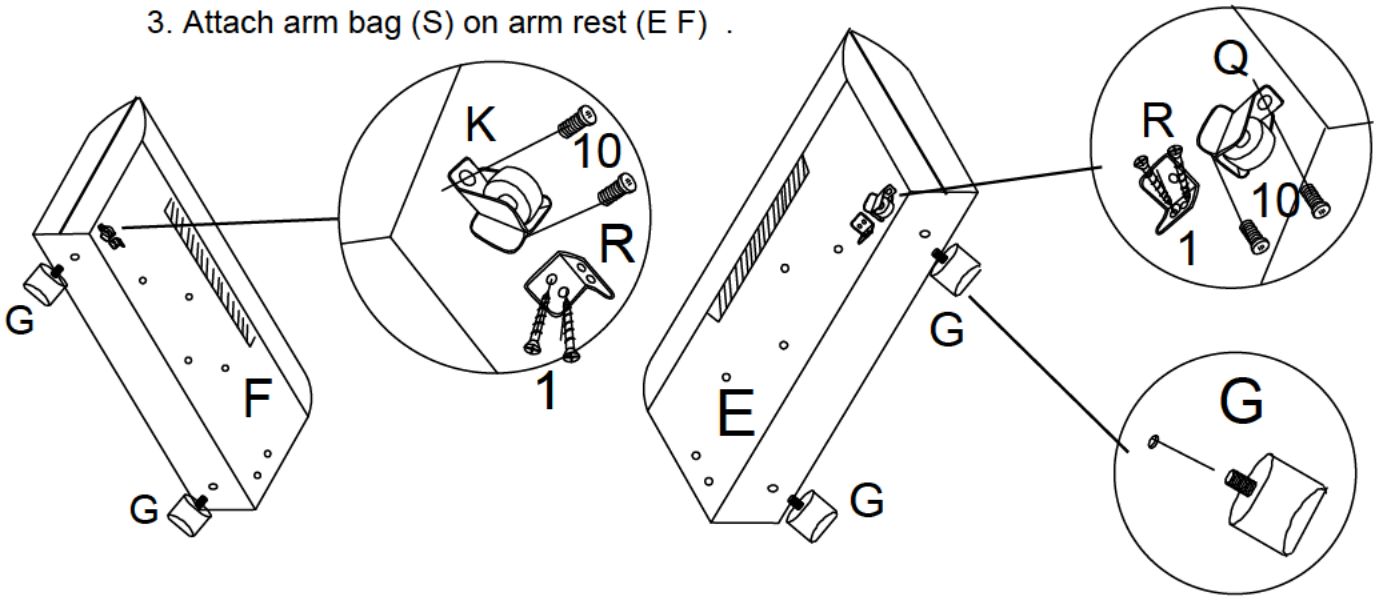

R	—		*2
Q	—		*1
K	—		*1
G	—		*4
1	—		*4
10	—		*4

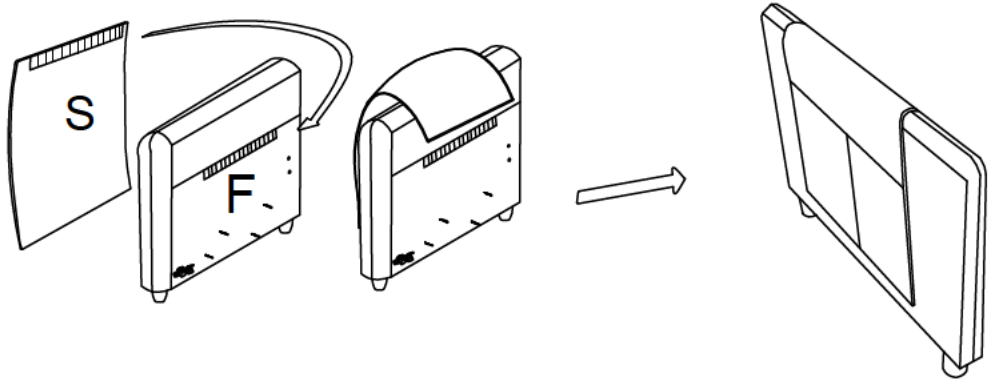

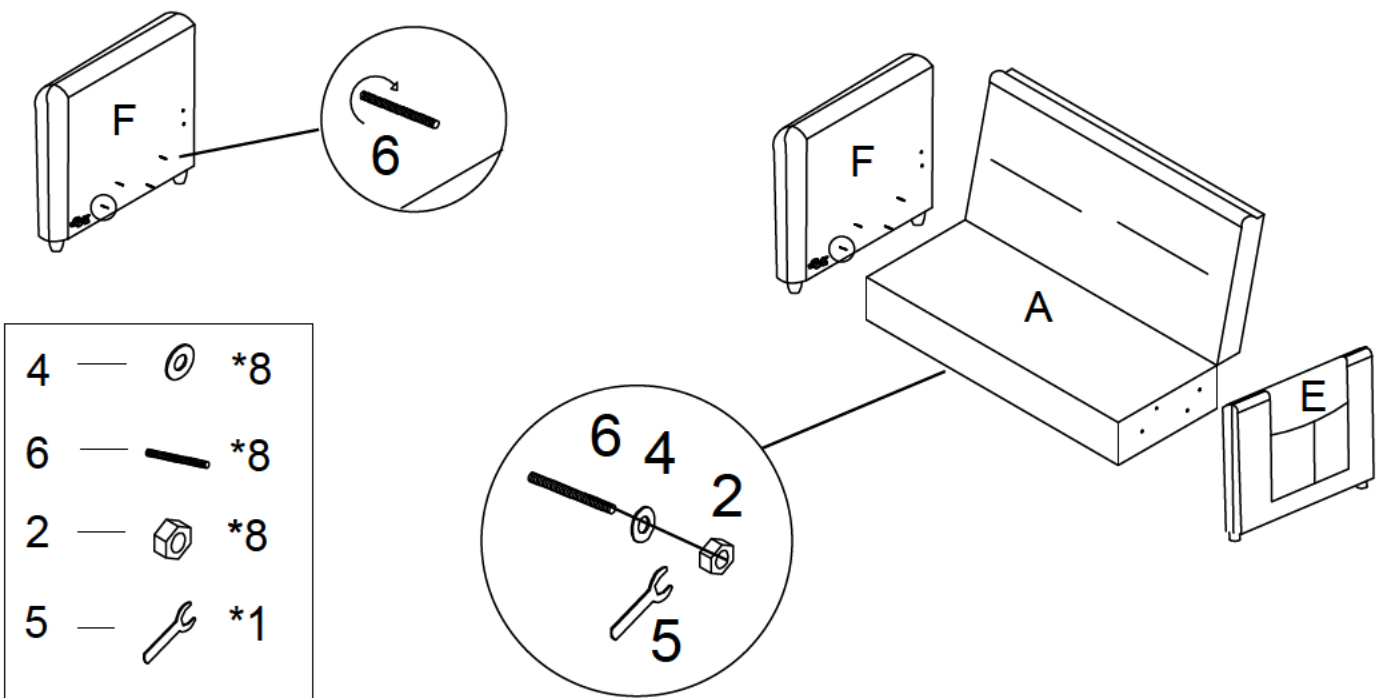

- STEP 2**
1. Screw Hang Bolts (6) to Armrest (E F).
  2. Attach Armrest (E F) to seat (A) using Flat washers (4) and Nuts (2).



4	—		*8
6	—		*8
2	—		*8
5	—		*1

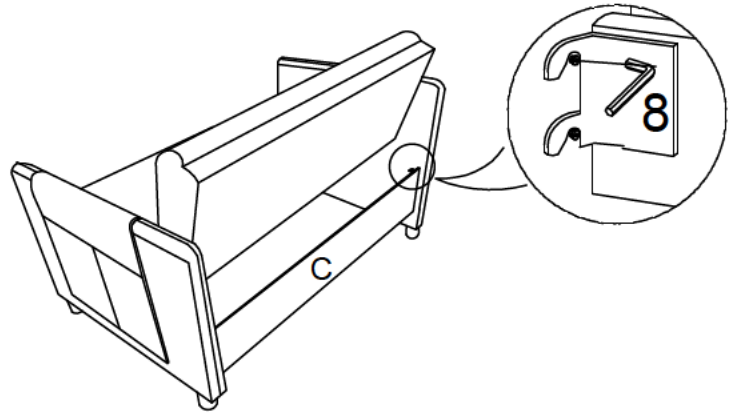
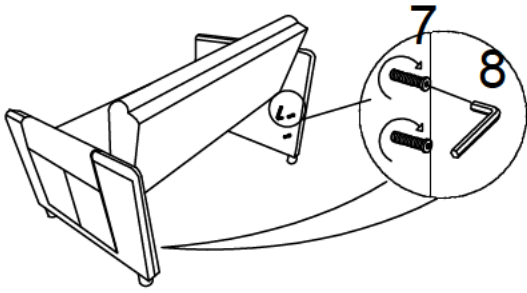



- STEP 3**
1. Screw bolts (7) by Allen Wrench(8) into holes in the back side of both Armrests,  
(Notice: PLS don't tighten bolts before next step)
  2. Install the hooker on the back panel (C) into bolts and tighten bolts (7) by Allen Wrench (8).

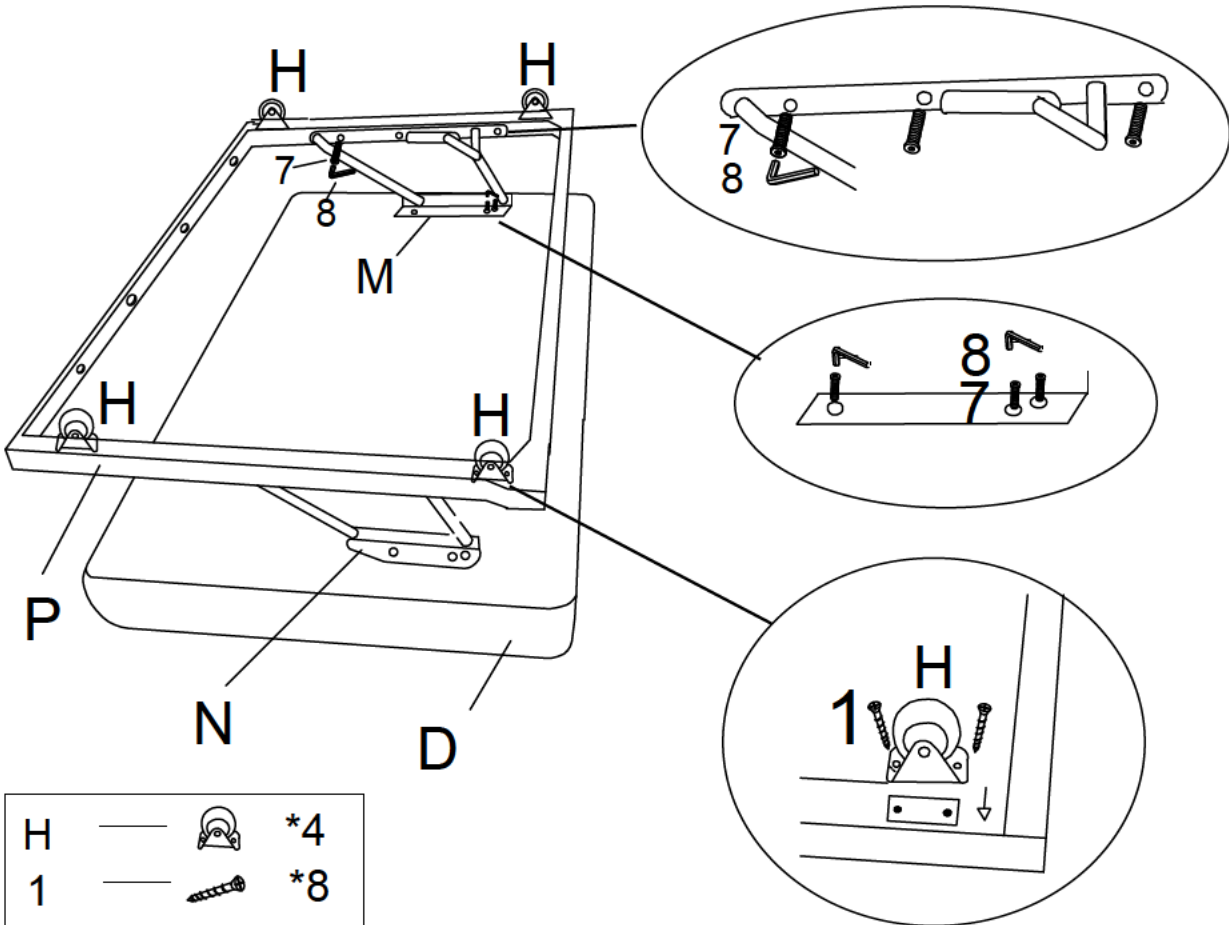

7	—		*4
8	—		*1

- STEP 4**
1. Attach the Lift Mech (M N) to the Sleeper Cushion Top(D) and sleeper sliding frame (P) using bolts (7) and tighten by Allen Wrench(8).
  2. Attach the Big Wheels (H) onto the bottom of the frame of the Sleeper Cushion(D) by Screws (1).







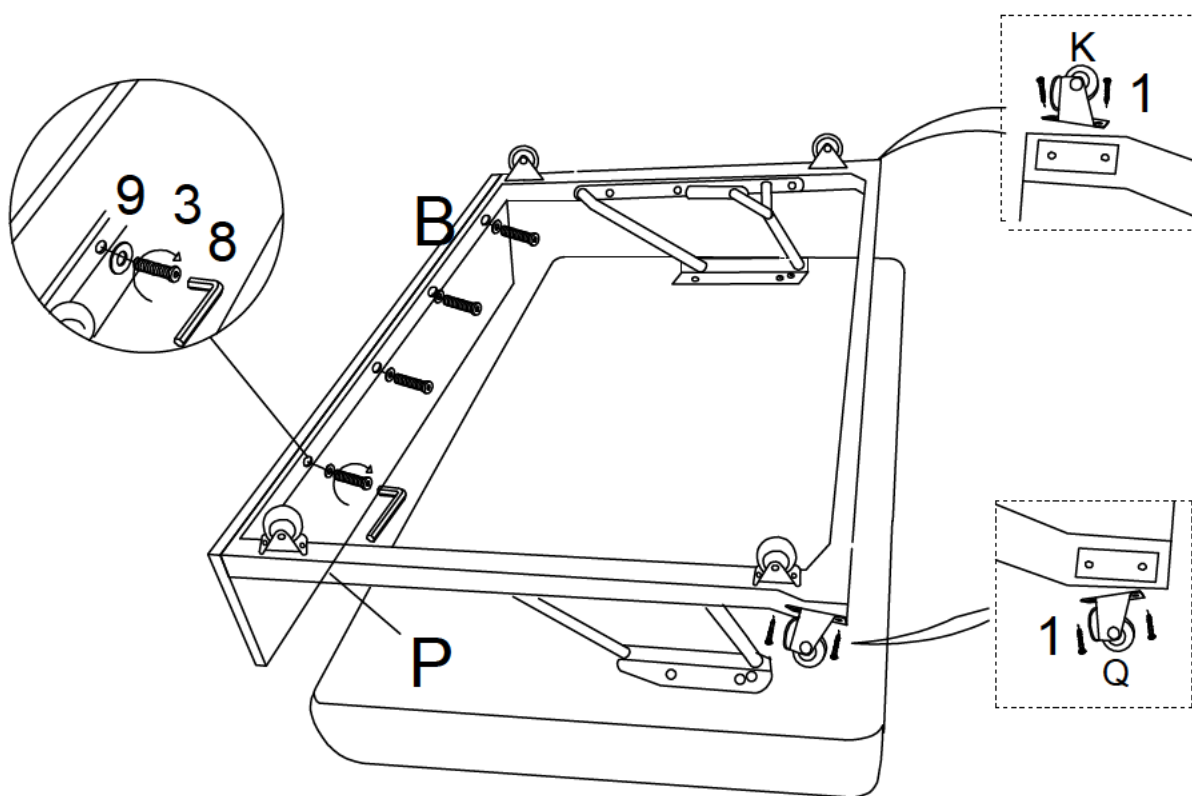

H	—		*4
1	—		*8
7	—		*12
8	—		*1

**STEP 5** 1. Attach the Small Wheels(K) onto the side of bottom frame of the Sleeper Cushion(P) by Screws(1).  
 (Notice: according to the location marks to attach the Wheels).

3. Attach the Sleeper front panel(B) onto the bottom frame of Sleeper Cushion(P) by Bolts(3).



9	—		*4	Q	—		*1
3	—		*4	K	—		*1
8	—		*1	1	—		*4

