

CEILING FAN LIGHT

INSTALLATION MANUAL

Ceiling Fan with Light

GET MORE SUPPORT

Should you experience any issues while operating any of our products, you can directly reach out to our Customer Support via Amazon Orders Or you can send your inquiry to our Official Customer Support at:



asyko1688@163.com



PLEASE KEEP CHILDREN AND PETS AWAY.

Contains screws, magnets, please keep away children/pets to avoid accidental ingestion.

ABOUT US

Company Profile

We are a leading manufacturer of lighting products, we have our own R & D base and production base. Our products are involved in commercial LED lighting, indoor and outdoor lighting and other fields. The company's products have been recognized and used by many countries, providing people with high-quality, energy-saving, beautiful artificial lighting products.

Contact Details

CATALOG

ABOUT US	01
CATALOG	02
INSTALL	03
REMOTE CONTROL	09
FAQ	11
WARRANTY	13

Dear Customer

Thank you very much for your support for our products. It's a great honor that our products can meet your needs. Every ceiling fan is made by workers hand working, If you are satisfied with our products, Could you please kindly help leave us a positive evaluation. Your positive evaluation is a great encouragement for us and can encourage us to do better in the future. If you have any questions about our products, please feel free to contact us. Finally, I sincerely wish you and your family a happy life.

INSTALL

1.Components and parts verification

Before you installation, please checking the parts one by one as below :

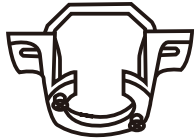

Hanging bracket

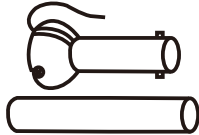

Down rod



Hanging cup



Bottom decorative cup

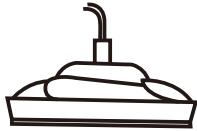

Motor body



Lampshade



Wood screws



One of the crystal



U-shaped needle



Spare parts for
balance sticker



Pair of gloves



Wiring caps



Remote controller



Retaining screws
for lamp shade
and crystal frame

Mounting Options

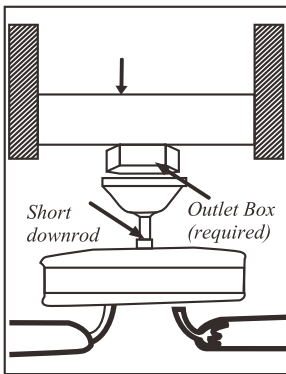

Use short downrod for flat and less than 9 feet ceiling.

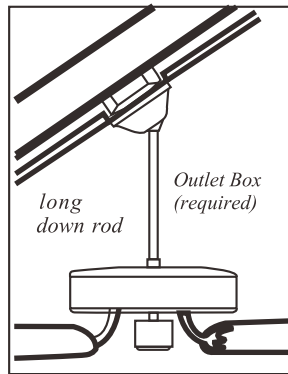

Use long downrod for high or angled ceiling less than 22°.

What to Expect with Your Installation

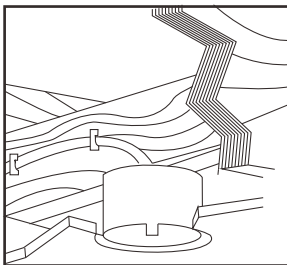

Must be able to secure the fan to building structure or fan-rated outlet box

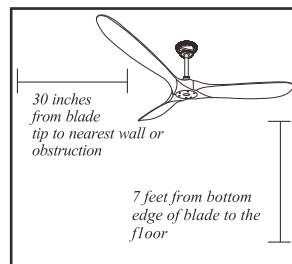

Assess location

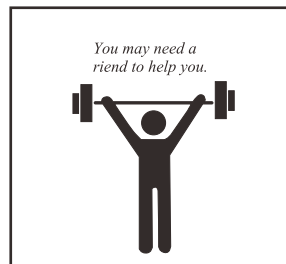

Check box to see fan weight

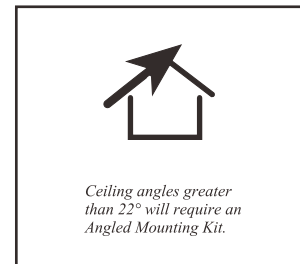

Assess ceiling angle

Installation Preparation



✓ Ladder



✓ Pliers



✓ Wire Strippers

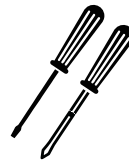

✓ Screwdrivers

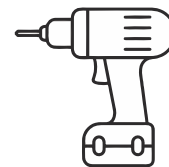

✓ Power Drill (optional)



✓ Drill Bit (optional)

If mounting to a support structure, you will also need the optional tools.

Note: For longer downrod or angled ceiling greater than 22°, please contact us.

2. Choose a way to install the hanging bracket

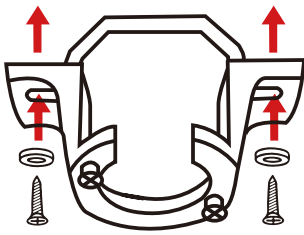

Installed on the wooden ceiling

Use a wood screw to fix the hanging bracket on a batten or beam. For safety, wooden ceiling thickness should exceed 0.42 inch, avoid loosening of wood screw.

3. Install bottom decorative cup/hanging cup/hanger

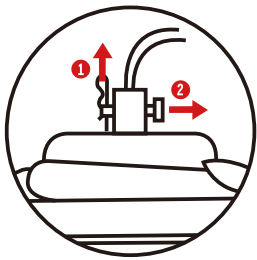

STEP 1

Pull out the R pin and side pin on the down rod

STEP 2

Make the down rod go through the bottom decorative cup, hanging cup, as shown in the drawing. Then let power cord go through the down rod from the bottom to the top. Insert the down rod into the motor interface. Tighten both sides screws to avoid fan light shaking.

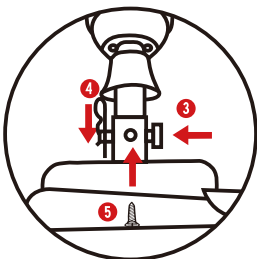

STEP 3

Insert the side pin and fix it with R pin

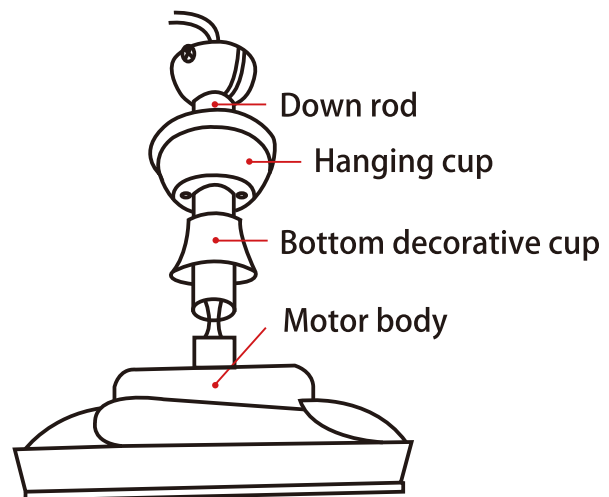

INSTALL

4. Install the lampshade

First, unscrew the four screws on the motor, then align the holes on the lampshade and motor, use the screws through the two holes, and tighten. Please check the drawing for reference. Depends on the model you purchased, Please check instruction picture below

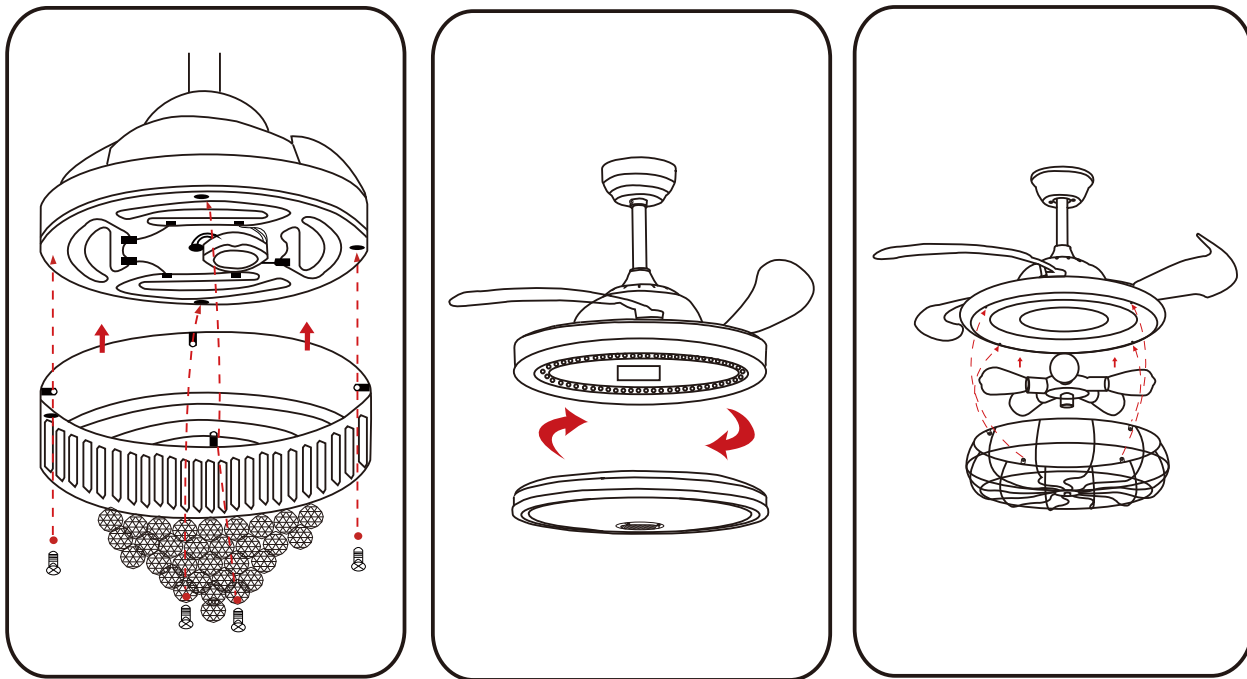

5. Install hanging all or finished (No crystal Ball)

Place the hanging ball in the hanging bracket and turn the boom until the groove of the ball mesh with the lug of the plate (inside the bracket).

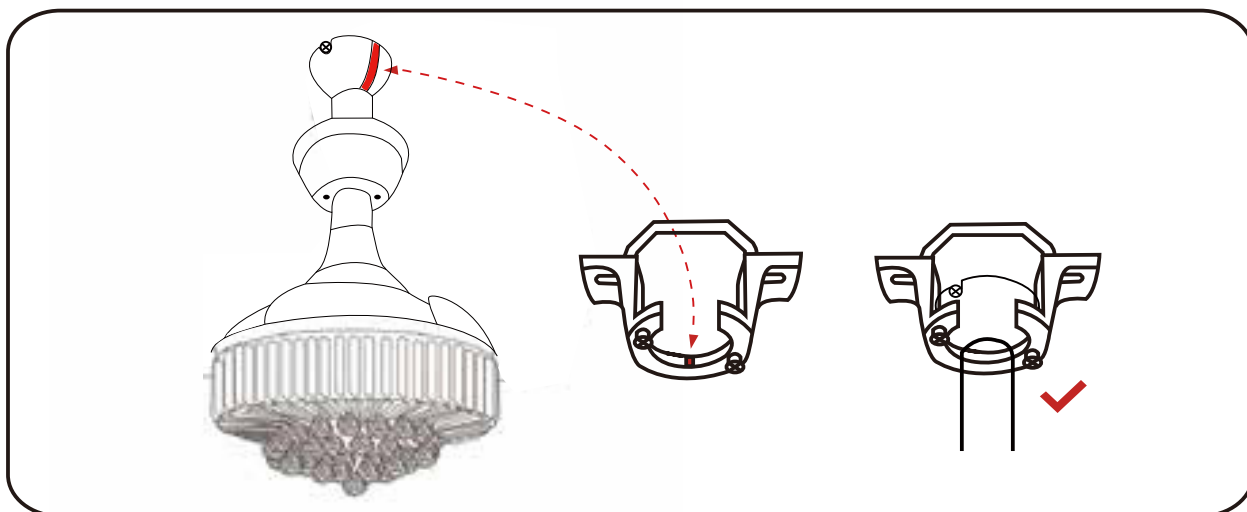

6. Connect the home power cord

Connect the wire in the down rod to the home power. For safety, please tighten the wiring caps.

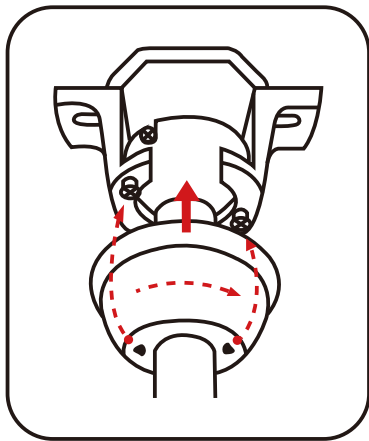

Please connect the green ground wire on the fan light to the ground wire at home (No need to connect if no ground wire at your home).

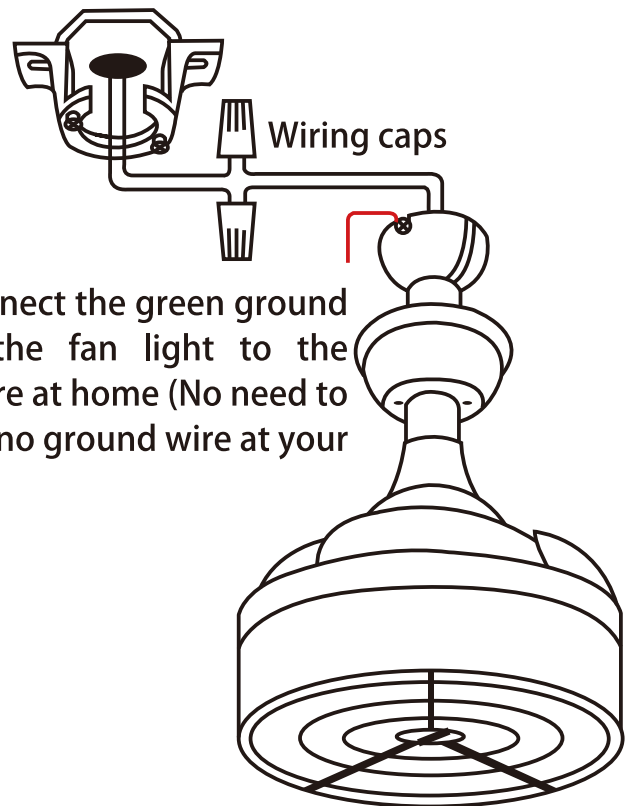

7. Fix the hanging cup

Pull out more than half of the two screws on the hanging bracket. (Don't pull out completely). Lift the hanging cup, let the screw pass through the notch of the hanging cup. Rotate the hanging cup to make it stuck and tight. Please check drawing for your reference.

Warning: The LN line of the product must correspond to the LN line of the power supply during installation, otherwise it will cause luminescence abnormality.

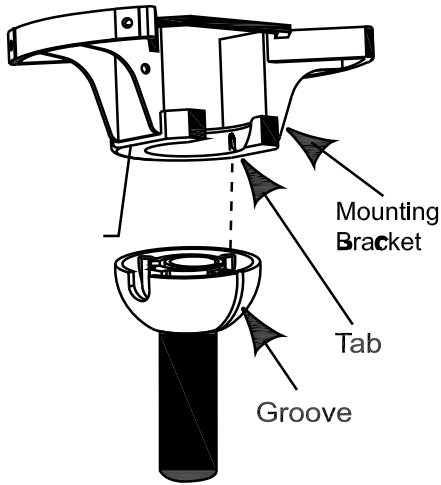

Carefully lift the fan and install the bar with the anchor in the mounting bracket already installed in the sky. that the groove of the anchor support is properly aligned with the mounting bracket tab. (Fig.5)

▲ WARNING

It is essential that the pin and safety pin are properly installed in the holder of the and that the fixing screws are well tightened.

The fan must be installed maintaining a minimum height of 2.30m. From the Bottom of the blades to the ground.

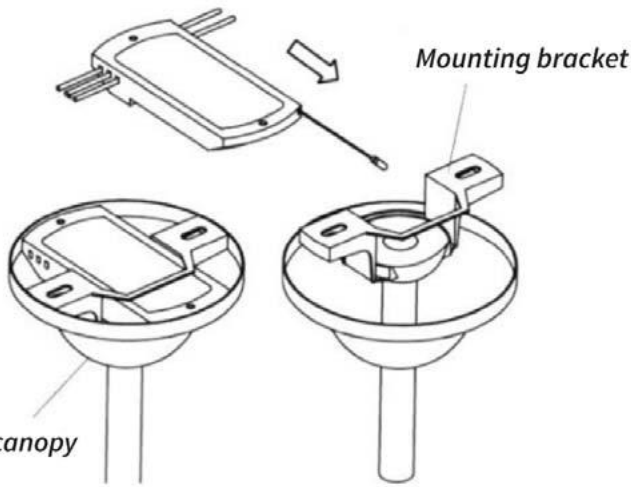

Insert the receiver into the mounting bracket.

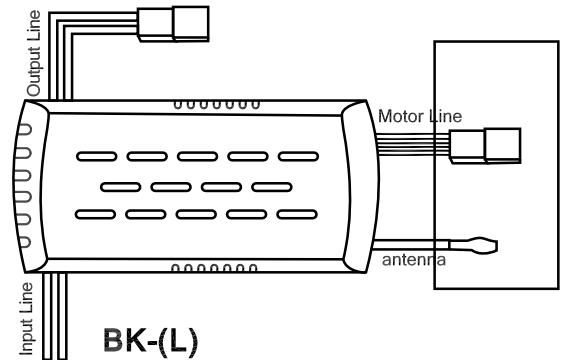

BK-(L)
WH-(N)

This electronic switch product needs to be operated by professionals during installation, remote trigger electronic switch the radio frequency of the remote control transmitter is 2.4 GHz.

INSTALL

8.hanging crystal(For Crystal Ceiling Fan Only)

Only the middle hole needs to hang crystal beads, and the length of the bead string can be adjusted as needed.(Except rectangular crystal model)

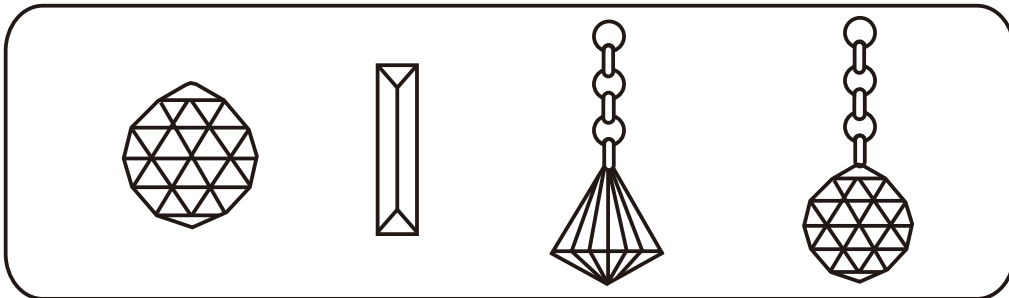

Hang the crystal with a U-shaped pin. Pass one end of the U shaped pin through the crystal. Bend or fold pin until the crystal does not fall. Pass the other end out of the small hole in the metal frame. Bend or fold pin to fix the crystal. Hang all crystals in this way.

(PS: Whatever ball crystal or Rectangular crystal)

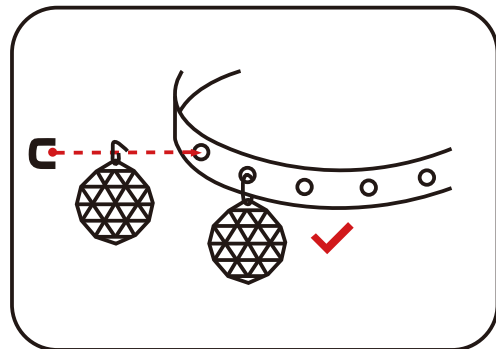
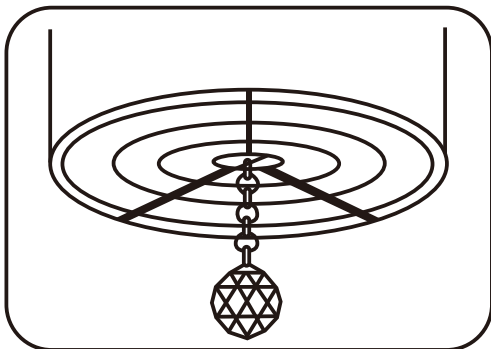

External maintenance

Use dry or slightly wet clean soft cotton cloth to wipe the external surface of the lamp body, do not use chemical cleaning agents, solvents or rough abrasives to clean the lamp surface.

Internal maintenance

Before cleaning the interior of the lamp, cut off the power supply first, and then use dry or slightly wet clean cotton cloth to wipe the interior surface of the lamp. For Blade cleaning, Please kindly contact for video guideline.

TIP: This part instructions is for normal crystal type installation, Please kindly contact us if this is not suitable for your model and you also need help.

REMOTE CONTROL

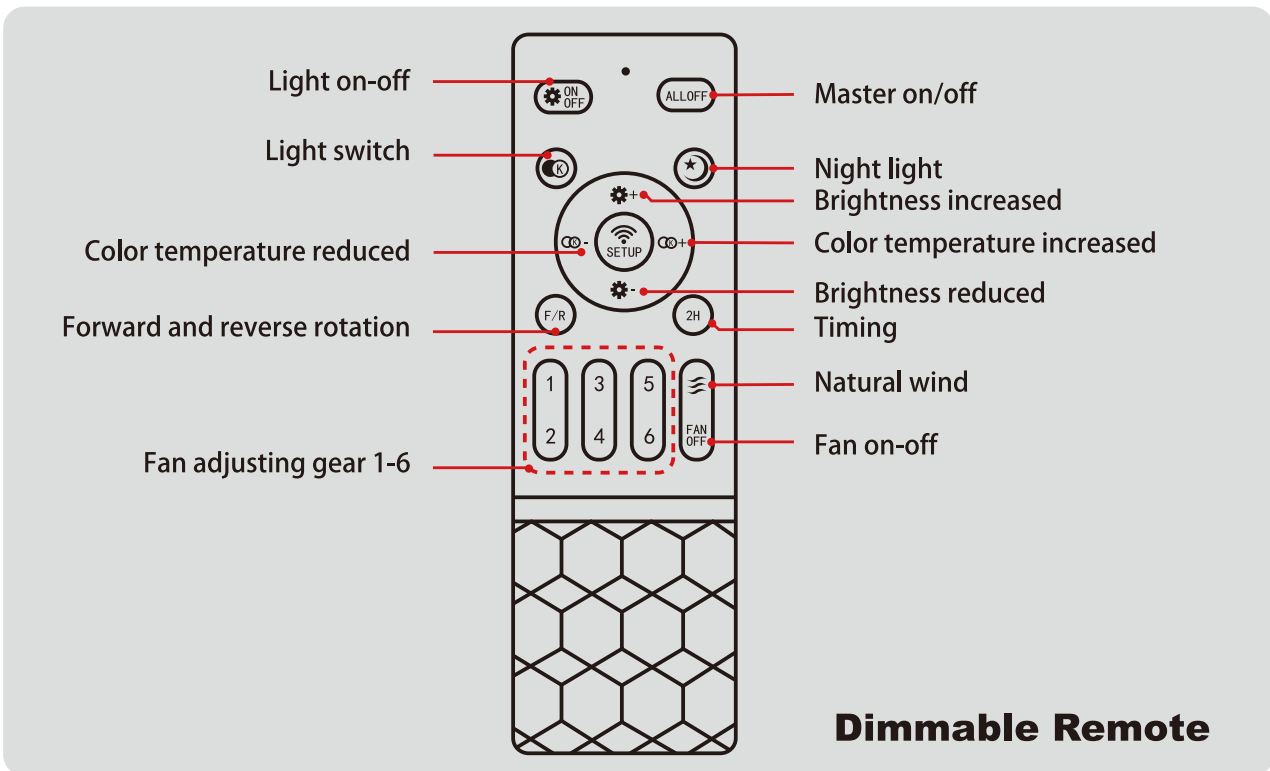

Color temperature + and - button: Long-press “+” or “-” button, you can adjust the temperature (500K-6500K) free.

Brightness + and - button: Long-press “+” or “-” button, you can adjust the brightness free.

Forward and Reverse rotation:

- 1.Forward rotation is better for Summer, the air flow is up to down.Cool down quickly.
- 2.Reverse Rotation is better for Winter, the air flow is down to up. Indoor air circulation

Remote need to be programmed, if you meet problems as following:

- 1.The fan is woking, but light is not;
- 2.The light is working, but fan is not;
- 3.The fan / light can be turned on, but light brightness and fan speed can not be changed.

How to programmed the remote?







For dimmable model : Please try to reconnect remote and ceiling fan if your remote can not control.

- 1.Power Off (Do not provide electricity)
- 2.Power On(Provide electricity) , Push Button(SET UP) soon in 3 seconds for 5 seconds.
- 3.Then It should connected.Please kindly contact our after sale if it still do not work.











APP Operation



- 1.Scan the QR code→Open the browser→Down load the APP
- 2.Open the APP→Select a room→Clickon+→Select"FanLight"→Enter the equipment name (such as fanlight)→OK
- 3.Clickon  enter

-  1.Language (English can be selected)
-  2.Scan(Scan the other party's QR code to share devicecontrol)
-  3.My QR code(You can share it with the other party)
-  4.Room management (Room name can be added)
-  5.Instructions (Choose the second interface fanlight, instructions for using various symbols of the device)
-  6.Check for updates
-  7.Feed back point to enter

APP Button Function Description

-  Pair button. In order to ensure that the application can successfully control the device, please click this button with in 5 seconds after the device is powered on. If the device flashes or beeps, it means that the phone has been successfully paired with the device, and then the device can be controlled through the application.
-  Click to select a time to turn off the device
-  The wind blown by the fan after clicking is like the wind in nature.
-  The wind blown by the fan after clicking is suitable for sleep.
-  The fan will rotate reverse after clicking
-  Click to change the direction of the wind
-  The fan will rotate forward after clicking
-  When you click, the white light and the yellow light will light up at the same time, but only at 10% of the maximum brightness.
-  When clicked, the white light and yellow light will light at the same time, and the brightness will be the maximum brightness.
-  When clicked, only yellow light will light up, and the brightness will be the maximum brightness.
-  When clicked, only white light will light up, and the brightness will be the maximum brightness.

FAQ

Each product is strictly checked by professional QC before shipment. Some accessories may be damaged by repeated moving in transit. In order to you have more better using experience, there are some questions and answers for your reference.

❓ If you accessories broken

- ✔ All easy damaged accessories, we promise replacement for free. Just take photos to customer service Email is ok.

❓ Fan working but light not working

- ✔ 1. Make sure the cilling fan and home power are wired correctly.
2. Make sure the fan and light board are well connected.
3. If the light still do not on, Please contact us.

❓ Remote not working/Light working but fan not working

- ✔ Due to transport problems programmed might be deleted, so you have to Reprogrammed by yourself. There are 2 ways solve it as below:
1. Please checking install manual on page 10 for reference. (how to Reprogrammed)
2. Try to contact customer service email.

❓ Fan Noise

- ★ Check if there are screws, washers, nuts and other debris.
- ★ Check the inner and outer disks for collision deformation

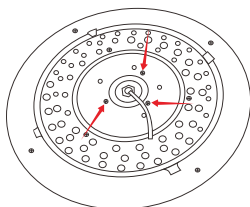

- ★ Check if the screws for fixing the fan blade and screws the lower rod are tight.

WARRANTY

Thanks for choose our product!

About Ceiling Fan, we will provide you promise and service as below:

Warranty Time

- 1.LED Panel: Within 2 years for free replace from order date.
- 2.Fan Motor: Within 2 years for free replace from order date.
- 3.Remote: Within 2 years for free replace from order date.
- 4.Other Parts: Within 2 years for free replace from order date.

Scope of warranty

The manufacturer warrants that the lamp can be repaired within 2 years from the date of purchase. During the warranty period, if there is any problem with the lamp, you can contact the relevant staff to repair or replace the product, The premise is that the failure of the product occurs under normal use, rather than the failure caused by man-made intentional damage. This warranty does not apply to the product failure caused by misuse, abuse, man-made damage, etc.

Out of warranty

This warranty does not apply to any product that is found to be faulty due to improper installation, improper setting or use not in accordance with the instructions. This warranty does not apply to the product failure caused by human damage, artificial change, misuse, abuse or wrong installation. This warranty does not apply to the repair of the external surface of the product, such as scratch, wear, weathering, etc., which are considered as normal wear parts of the product.

Return/Replacement Policy

We are sorry for you not satisfied on our product When you choose Return / Replacement,please checking policy carefully as following:

Period of Validity

After you get package within 30 days.

Defect of Product

Due to the product defect, you want to return it, we suggest you contact us first, we will replace parts you need for free.

Return Package Must Be

- 1.Complete parts of the product.
- 2.Non trace of use or installation.
- 3.Original package and foam box.
- 4.No-influence second selling.

Privacy Protection

All provide contact way for help only, we will promise protect your privacy.Thanks for your cooperation and support!

**THANK YOU
FOR USING!**

Any problems during the installation and using, Please feel free to contact us!