

# ASSEMBLY INSTRUCTIONS INSTRUCTIONS DE MONTAGE INSTRUCCIONES DE MONTAJE





WOOD QUEEN BED ARCHED HEADBOARD KD  
WOOD KING BED ARCHED HEADBOARD KD





**CAUTION:** PLEASE READ ALL INSTRUCTIONS BEFORE STARTING THE ASSEMBLY OF THIS PRODUCT. THESE PIECES ARE HEAVY. IN ORDER TO PREVENT PERSONAL INJURY AND ENSURE THAT THIS PRODUCT IS NOT DAMAGED DURING THE ASSEMBLY PROCESS, IT IS STRONGLY RECOMMENDED TO ENLIST THE ASSISTANCE OF ONE OR MORE PERSONS. IN CASE OF EXCESS STAIN, WIPE THE BOTTOM OF THE UNIT BEFORE PLACING ON ANY SURFACE.

**ATTENTION:** VEUILLEZ LIRE TOUTES LES INSTRUCTIONS AVANT DE COMMENCER L'ASSEMBLAGE DE CE PRODUIT. LES PIECES SONT LOURDES. POUR EVITER TOUTE BLESSURE ET POUR VOUS ASSURER QUE LE PRODUIT N'EST PAS ENDOMMAGE' PENDANT L'ASSEMBLAGE, NOUS VOUS RECOMMANDONS DE FAIRE APPEL A UNE OU PLUSIEURS AUTRES PERSONNES. EN CAS DE TACHE EXCESSIVE, ESSUYEZ LE FOND DE L'UNITE' AVANT LE PLACEMENT SUR N'IMPORTE QUELLE SURFACE.

**CUIDADO:** FAVOR DE LEER TODAS LAS INSTRUCCIONES ANTES DE ENSAMBLAR SU PRODUCTO, ESTAS. PIEZAS SON PESADAS. PARA PREVENIR HERIDAS PERSONALES Y ASEGURAR QUE SU PRODUCTO NO SEA DAN ADO MIENTRAS ES ENSAMBLADO. SE RECOMIENDA LA ASISTENCIA DE UNA O MAUS PERSONAS.

**WARNING:** PROTECTIVE GLIDE IS PLACED UNDER EACH LEG OF THE FURNITURE TO RESIST SCRATCHES ON FLOOR SURFACE. SOME FLOOR SURFACES CAN BE EXTRA SENSITIVE TO SCRATCHES AND MARKINGS, IF YOU ARE NOT SURE CONSULT WITH YOUR DEALER.  
AVERTISSEMENT. LES PIEDS DES MEUBLES SONT MUNIS DE PATINS DESTINES A PROTEGER LE PLANCHER. CERTAINS REVETEMENTS DE SOL PEUVENT ETRE TRES FRAGILES. EN CAS DE DOUTE. CONSULTER LE MARCHAND.

LIST OF PARTS AND HARDWARE/ LISTE DES PIÈCES ET DU MATÉRIEL/ LISTA DE PIEZAS Y HARDWARE			
NO#/ NOMBRE/ NÚMERO	DESCRIPTION/ DESCRIPTION/ DESCRIPCIÓN		QUANTITY/ QUANTITÉ/ CANTIDAD
A	FLAT WASHER/ RONDELLE PLATE/ ARANDELA PLANA	$\phi 5/16" * 3/4"$ 	12 PCS
B	LOCK WASHER/ RONDELLE DE BLOCAGE/ ARANDELA DE BLOQUEO	$\phi 5/16" * 1/2"$ 	12 PCS
C	BOLT/ BOULON/ TORNILLO	$\phi 5/16" * 1-1/2" L$ 	12 PCS
D	ALLEN WRENCH/ CLÉ ALLEN/ LLAVE INGLESA ALLEN	4mm 	1 PC

LIST OF PARTS AND HARDWARE/ LISTE DES PIÈCES ET DU MATÉRIEL/ LISTA DE PIEZAS Y HARDWARE			
NO#/ NOMBRE/ NÚMERO	DESCRIPTION/ DESCRIPTION/ DESCRIPCIÓN		QUANTITY/ QUANTITÉ/ CANTIDAD
1	HEADBOARD/ TÊTE DE LIT/ CABECERA		1 PC
2	HEADBOARD LEG (LEFT)/ PATTE TÊTE DE LIT (GAUCHE) / PIERNA DE CABECERA (IZQUIERDA)		1 PC
3	HEADBOARD LEG (RIGHT)/ PATTE TÊTE DE LIT (DROITE) / PIERNA DE CABECERA (DERECHO)		1 PC
4	BOTTOM STRETCHER/ RALLONGE DU BAS/ CAMILLA INFERIOR		1 PC
5	MENDING PLATE/ PLAQUE DE RÉPARATION/ PLACA DE REPARACIÓN		2 PCS

NOTE:  
ASSEMBLE UNIT ON A SOFT SURFACE.  
ASSEMBLEZ L'UNITÉ SUR UNE SURFACE MOLLE.  
ENSAMBLE LA UNIDAD EN UNA SUPERFICIE PLANA Y SUAVE.

DO NOT TIGHTEN BOLTS UNTIL THE UNIT IS COMPLETELY ASSEMBLED.  
NE SERREZ PAS LES BOULONS JUSQU'À CE QUE L'UNITÉ SOIT COMPLÈTEMENT ASSEMBLÉE.  
NO APRIETE LOS TORNILLOS HASTA QUE LA UNIDAD ESTE COMPLETAMENTE ENSAMBLADA.

ASSEMBLY INSTRUCTIONS  
INSTRUCTIONS DE MONTAGE  
INSTRUCCIONES DE MONTAJE

WOOD QUEEN BED ARCHED HEADBOARD KD  
WOOD KING BED ARCHED HEADBOARD KD

Note/ Remarque/ nota:

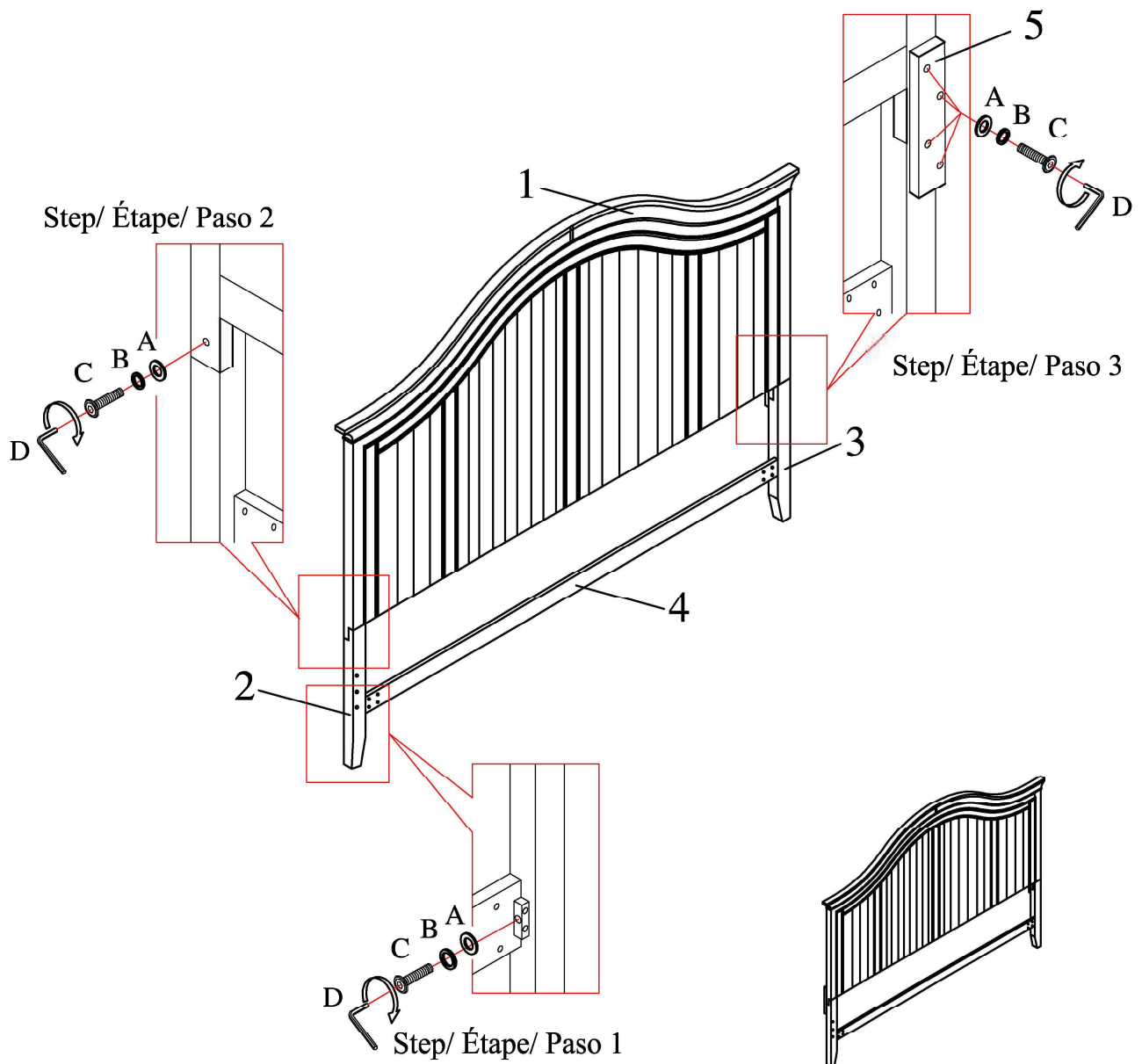
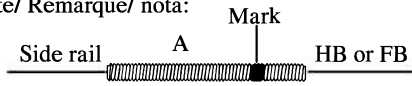

# ASSEMBLY INSTRUCTIONS INSTRUCTIONS DE MONTAGE INSTRUCCIONES DE MONTAJE

KING PANEL HEADBOARD  
KING PANEL FOOTBOARD  
QUEEN/KING PANEL BED REGULAR RAILS









**CAUTION:** PLEASE READ ALL INSTRUCTIONS BEFORE STARTING THE ASSEMBLY OF THIS PRODUCT. THESE PIECES ARE HEAVY. IN ORDER TO PREVENT PERSONAL INJURY AND ENSURE THAT THIS PRODUCT IS NOT DAMAGED DURING THE ASSEMBLY PROCESS, IT IS STRONGLY RECOMMENDED TO ENLIST THE ASSISTANCE OF ONE OR MORE PERSONS. IN CASE OF EXCESS STAIN, WIPE THE BOTTOM OF THE UNIT BEFORE PLACING ON ANY SURFACE.

**ATTENTION:** VEUILLEZ LIRE TOUTES LES INSTRUCTIONS AVANT DE COMMENCER L'ASSEMBLAGE DE CE PRODUIT. LES PIÈCES SONT LOURDES. POUR ÉVITER TOUTE BLESSURE ET POUR VOUS ASSURER QUE LE PRODUIT N'EST PAS ENDOMMAGÉ PENDANT L'ASSEMBLAGE, NOUS VOUS RECOMMANDONS DE FAIRE APPEL À UNE OU PLUSIEURS AUTRES PERSONNES. EN CAS DE TACHE EXCESSIVE, ESSUYEZ LE FOND DE L'UNITÉ AVANT LE PLACEMENT SUR N'IMPORTE QUELLE SURFACE.









**CUIDADO:** FAVOR DE LEER TODAS LAS INSTRUCCIONES ANTES DE ENSAMBLAR SU PRODUCTO, ESTAS. PIEZAS SON PESADAS. PARA PREVENIR HERIDAS PERSONALES Y ASEGURAR QUE SU PRODUCTO NO SEA DANADO MIENTRAS ES ENSAMBLADO. SE RECOMIENDA LA ASISTENCIA DE UNA O MAUS PERSONAS.

**WARNING:** PROTECTIVE GLIDE IS PLACED UNDER EACH LEG OF THE FURNITURE TO RESIST SCRATCHES ON FLOOR SURFACE. SOME FLOOR SURFACES CAN BE EXTRA SENSITIVE TO SCRATCHES AND MARKINGS, IF YOU ARE NOT SURE CONSULT WITH YOUR DEALER.  
AVERTISSEMENT. LES PIEDS DES MEUBLES SONT MUNIS DE PATINS DESTINÉS À PROTÉGER LE PLANCHER. CERTAINS REVÊTEMENTS DE SOL PEUVENT ÊTRE TRÈS FRAGILES. EN CAS DE DOUTE, CONSULTEZ LE MARCHAND.

## LIST OF PARTS AND HARDWARE/ LISTE DES PIÈCES ET DU MATÉRIEL/ LISTA DE PIEZAS Y HARDWARE

NO#/ NOMBRE/ NÚMERO	DESCRIPTION/ DESCRIPTION/ DESCRIPCIÓN	QUANTITY/ QUANTITÉ/ CANTIDAD
A	STUDS/ STUDS/ LOS ESTUDIOS $\phi 5/16" \times 4-1/2" L$ 	8 PCS
B	LOCK WASHER "C"/ RONDELLE DE BLOCAGE "C"/ ARANDELA DE BLOQUEO "C" $\phi 5/16" \times 36 \times 15 \times 3 \text{mm}$ 	8 PCS
C	NUT/ ÉCROU/ NUEZ $\phi 5/16" \times 12 \text{mm}$ 	8 PCS
D	WRENCH/ CLÉ/ LLAVE INGLESA 12mm 	1 PC
E	FLAT WASHER/ RONDELLE PLATE/ ARANDELA PLANA $\phi 5/16" \times 18 \times 1.5 \text{mm}$ 	12 PCS
F	LOCK WASHER/ RONDELLE DE BLOCAGE/ ARANDELA DE BLOQUEO $\phi 5/16" \times 13 \times 1 \text{mm}$ 	12 PCS
G	BOLT/ BOULON/ TORNILLO $\phi 5/16" \times 1-1/2" L$ 	12 PCS
H	ALLEN WRENCH/ CLÉ ALLEN/ LLAVE INGLESA ALLEN 4mm 	1 PCS
I	SCREW/ VIS/ TORNILLO #4*25 	8 PCS

## LIST OF PARTS AND HARDWARE/ LISTE DES PIÈCES ET DU MATÉRIEL/ LISTA DE PIEZAS Y HARDWARE

NO#/ NOMBRE/ NÚMERO	DESCRIPTION/ DESCRIPTION/ DESCRIPCIÓN	QUANTITY/ QUANTITÉ/ CANTIDAD
1	HEADBOARD/ TÊTE DE LIT/ CABECERA 	1 PC
2	HEADBOARD LEG (LEFT)/ PATTE TÊTE DE LIT (GAUCHE)/ PIERNA DE CABECERA (IZQUIERDA) 	1 PC
3	HEADBOARD LEG (RIGHT)/ PATTE TÊTE DE LIT (DROITE)/ PIERNA DE CABECERA (DERECHA) 	1 PC
4	BOTTOM STRETCHER/ RALLONGE DU BAS/ CAMILLA INFERIOR 	1 PC
5	MENDING PLATE/ PLAQUE DE RÉPARATION/ PLACA DE REPARACIÓN 	2 PCS
6	FOOTBOARD/ PIED DE LIT/ ESTRIBO 	1 PC
7	SIDE RAIL/ RAIL LATÉRAL/ CARRIL LATERAL 	2 PCS
8	HORIZONTAL SLATS (1954mm)/ HORIZONTAL LATTES (1954mm)/ HORIZONTAL LISTONES (1954mm) 	4 PCS
9	SLAT SUPPORT (190mm)/ LATTES D'APPUI (190mm)/ LISTONES DE APOYO (190mm) 	12 PCS

NOTE:  
ASSEMBLE UNIT ON A SOFT SURFACE.  
ASSEMBLEZ L'UNITÉ SUR UNE SURFACE MOLLE.  
ENSAMBLE LA UNIDAD EN UNA SUPERFICIE PLANA Y SUAVE.

DO NOT TIGHTEN BOLTS UNTIL THE UNIT IS COMPLETELY ASSEMBLED.  
NE SERREZ PAS LES BOULONS JUSQU'À CE QUE L'UNITÉ SOIT COMPLÈTEMENT ASSEMBLÉE.  
NO APRIETE LOS TORNILLOS HASTA QUE LA UNIDAD ESTE COMPLETAMENTE ENSAMBLADA.

# ASSEMBLY INSTRUCTIONS INSTRUCTIONS DE MONTAGE INSTRUCCIONES DE MONTAJE

KING PANEL HEADBOARD  
KING PANEL FOOTBOARD  
QUEEN/KING PANEL BED REGULAR RAILS

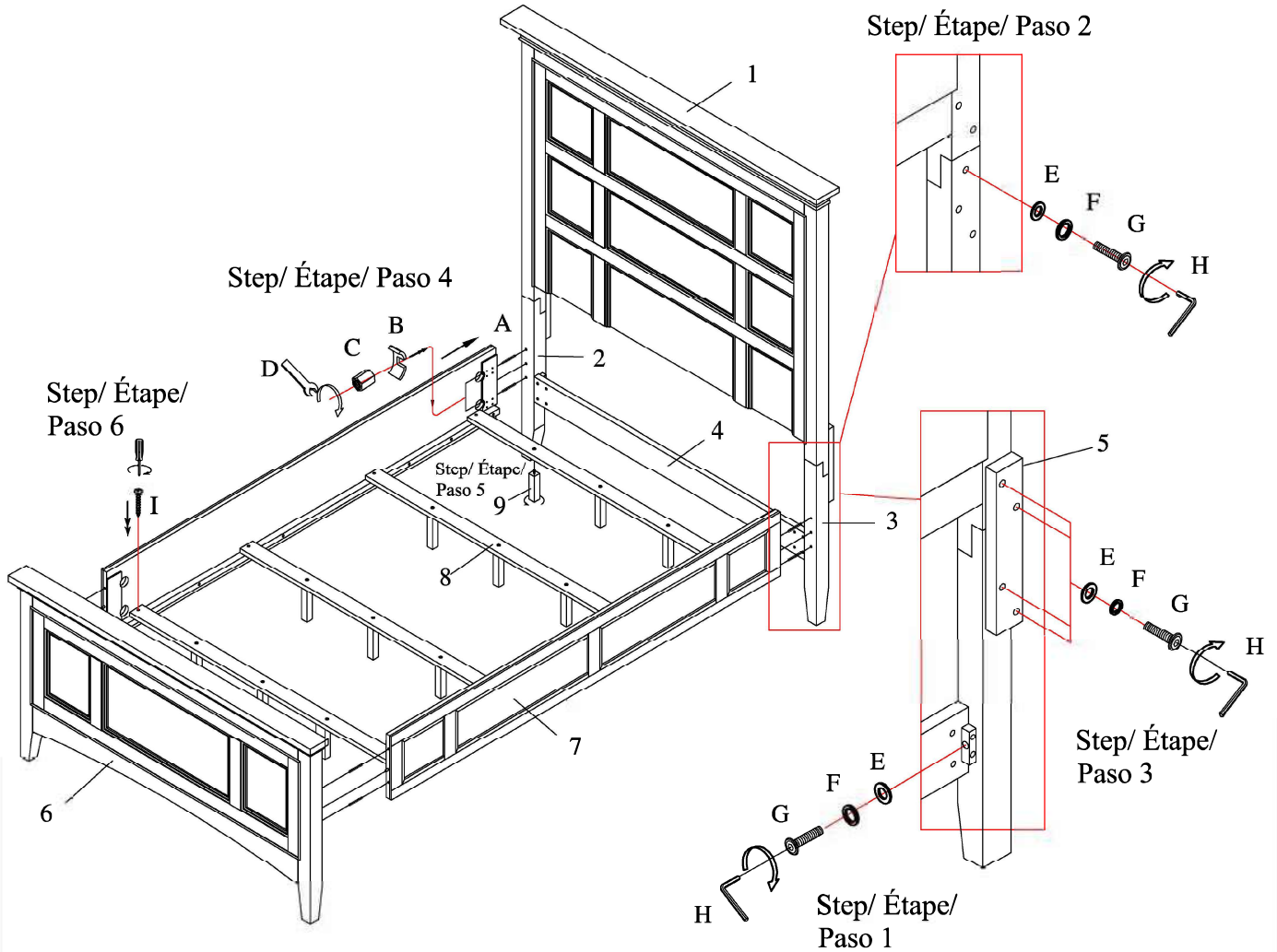
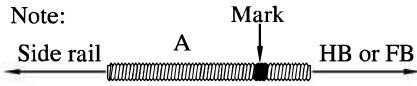

# ASSEMBLY INSTRUCTIONS INSTRUCTIONS DE MONTAGE INSTRUCCIONES DE MONTAJE

KING PANEL HEADBOARD  
KING PANEL FOOTBOARD  
KING PANEL BED STORAGE RAILS









**CAUTION:** PLEASE READ ALL INSTRUCTIONS BEFORE STARTING THE ASSEMBLY OF THIS PRODUCT. THESE PIECES ARE HEAVY. IN ORDER TO PREVENT PERSONAL INJURY AND ENSURE THAT THIS PRODUCT IS NOT DAMAGED DURING THE ASSEMBLY PROCESS, IT IS STRONGLY RECOMMENDED TO ENLIST THE ASSISTANCE OF ONE OR MORE PERSONS. IN CASE OF EXCESS STAIN, WIPE THE BOTTOM OF THE UNIT BEFORE PLACING ON ANY SURFACE.

**ATTENTION:** VEUILLEZ LIRE TOUTES LES INSTRUCTIONS AVANT DE COMMENCER L'ASSEMBLAGE DE CE PRODUIT. LES PIECES SONT LOURDES. POUR EVITER TOUTE BLESSURE ET POUR VOUS ASSURER QUE LE PRODUIT N'EST PAS ENDOMMAGE' PENDANT L'ASSEMBLAGE, NOUS VOUS RECOMMANDONS DE FAIRE APPEL A UNE OU PLUSIEURS AUTRES PERSONNES. EN CAS DE TACHE EXCESSIVE, ESSUYEZ LE FOND DE L'UNITE' AVANT LE PLACEMENT SUR N'IMPORTE QUELLE SURFACE.











**CUIDADO:** FAVOR DE LEER TODAS LAS INSTRUCCIONES ANTES DE ENSAMBLAR SU PRODUCTO, ESTAS. PIEZAS SON PESADAS. PARA PREVENIR HERIDAS PERSONALES Y ASEGURAR QUE SU PRODUCTO NO SEA DAN ADO MIENTRAS ES ENSAMBLADO. SE RECOMIENDA LA ASISTENCIA DE UNA O MAUS PERSONAS.

**WARNING:** PROTECTIVE GLIDE IS PLACED UNDER EACH LEG OF THE FURNITURE TO RESIST SCRATCHES ON FLOOR SURFACE. SOME FLOOR SURFACES CAN BE EXTRA SENSITIVE TO SCRATCHES AND MARKINGS, IF YOU ARE NOT SURE CONSULT WITH YOUR DEALER. AVERTISSEMENT. LES PIEDS DES MEUBLES SONT MUNIS DE PATINS DESTINES A PROTEGER LE PLANCHER. CERTAINS REVETEMENTS DE SOL PEUVENT ETRE TRES FRAGILES. EN CAS DE DOUTE. CONSULTER LE MARCHAND.

## LIST OF PARTS AND HARDWARE/ LISTE DES PIÈCES ET DU MATÉRIEL/ LISTA DE PIEZAS Y HARDWARE

NO#/ NOMBRE/ NÚMERO	DESCRIPTION/ DESCRIPTION/ DESCRIPCIÓN	QUANTITY/ QUANTITÉ/ CANTIDAD
A	STUDS/ STUDS/ LOS ESTUDIOS $\phi 5/16" \times 4-1/2" L$ 	8 PCS
B	LOCK WASHER "C"/ RONDELLE DE BLOCAGE "C"/ ARANDELA DE BLOQUEO "C" $\phi 5/16" \times 36 \times 15 \times 3 \text{mm}$ 	8 PCS
C	NUT/ ÉCROU/ NUEZ $\phi 5/16" \times 12 \text{mm}$ 	8 PCS
D	WRENCH/ CLÉ/ LLAVE INGLESA 12mm 	1 PC
E	FLAT WASHER/ RONDELLE PLATE/ ARANDELA PLANA $\phi 5/16" \times 18 \times 1.5 \text{mm}$ 	12 PCS
F	LOCK WASHER/ RONDELLE DE BLOCAGE/ ARANDELA DE BLOQUEO $\phi 5/16" \times 13 \times 1 \text{mm}$ 	12 PCS
G	BOLT/ BOULON/ TORNILLO $\phi 5/16" \times 1-1/2" L$ 	12 PCS
H	ALLEN WRENCH/ CLÉ ALLEN/ LLAVE INGLESA ALLEN 4mm 	1 PC
I	SCREW/ VIS/ TORNILLO #4*25 	24 PCS

## LIST OF PARTS AND HARDWARE/ LISTE DES PIÈCES ET DU MATÉRIEL/ LISTA DE PIEZAS Y HARDWARE

NO#/ NOMBRE/ NÚMERO	DESCRIPTION/ DESCRIPTION/ DESCRIPCIÓN	QUANTITY/ QUANTITÉ/ CANTIDAD
1	HEADBOARD/ 'IBTE DE LIT/ CABECERA 	1 PC
2	HEADBOARD LEG (LEFT)/ PATTE TÊTE DE LIT(GAUCHE)/ PIERNA DE CABECERA(IZQUIERDA) 	1 PC
3	HEADBOARD LEG (RIGHT)/ PATTE TÊTE DE LIT (DROITE)/ PIERNA DE CABECERA (DERECHA) 	1 PC
4	BOTTOM STRETCHER/ RALLONGE DU BAS/ CAMILLA INFERIOR 	1 PC
5	MENDING PLATE/ PLAQUE DE RÉPARATION/ PLACA DE REPARACIÓN 	2 PCS
6	FOOTBOARD/ PIED DE LIT/ ESTRIBO 	1 PC
7	SIDE RAIL/ RAIL LATÉRAL/ CARRIL LATERAL 	2 PCS
8	HORIZONTAL SLATS (1954mm)/ HORIZONTAL LATTES (1954mm)/ HORIZONTAL LISTONES (1954mm) 	12 PCS
9	VERTICAL SLATS (915mm)/ VERTICAL LATTES (915mm)/ VERTICAL LISTONES (915mm) 	2 PCS
10	SLAT SUPPORT (402mm)/ LATTES D'APPUI (402mm)/ LISTONES DE APOYO (402mm) 	4 PCS
11	SUPPORT LEGS (138mm)/ JAMBE D'APPUI (138mm)/ PIERNA DE APOYO (138mm) 	6 PCS

NOTE:  
ASSEMBLE UNIT ON A SOFT SURFACE.  
ASSEMBLEZ L'UNITÉ SUR UNE SURFACE MOLLE.  
ENSAMBLE LA UNIDAD EN UNA SUPERFICIE PLANA Y SUAVE.

DO NOT TIGHTEN BOLTS UNTIL THE UNIT IS COMPLETELY ASSEMBLED.  
NE SERREZ PAS LES BOULONS JUSQU'À CE QUE L'UNITÉ SOIT COMPLÈTEMENT ASSEMBLÉE.  
NO APRIETE LOS TORNILLOS HASTA QUE LA UNIDAD ESTE COMPLETAMENTE ENSAMBLADA.

# ASSEMBLY INSTRUCTIONS INSTRUCTIONS DE MONTAGE INSTRUCCIONES DE MONTAJE

KING PANEL HEADBOARD  
KING PANEL FOOTBOARD  
KING PANEL BED STORAGE RAILS

Note/ Remarque/ nota:

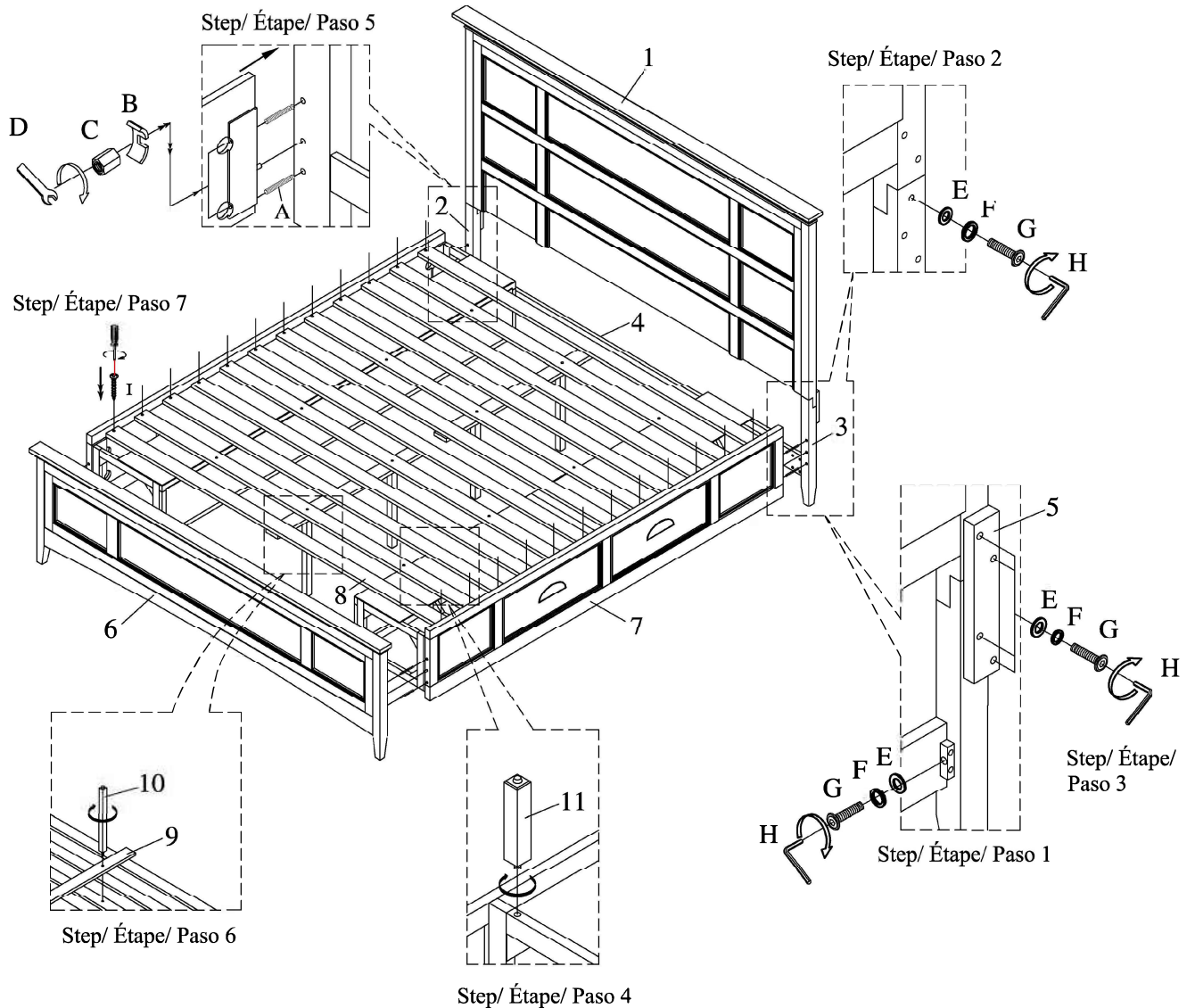
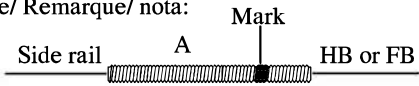

# ASSEMBLY INSTRUCTIONS INSTRUCTIONS DE MONTAGE INSTRUCCIONES DE MONTAJE

QUEEN PANEL HEADBOARD  
QUEEN PANEL FOOTBOARD  
QUEEN/KING PANEL BED REGULAR RAILS









**CAUTION:** PLEASE READ ALL INSTRUCTIONS BEFORE STARTING THE ASSEMBLY OF THIS PRODUCT. THESE PIECES ARE HEAVY. IN ORDER TO PREVENT PERSONAL INJURY AND ENSURE THAT THIS PRODUCT IS NOT DAMAGED DURING THE ASSEMBLY PROCESS, IT IS STRONGLY RECOMMENDED TO ENLIST THE ASSISTANCE OF ONE OR MORE PERSONS. IN CASE OF EXCESS STAIN, WIPE THE BOTTOM OF THE UNIT BEFORE PLACING ON ANY SURFACE.

**ATTENTION:** VEUILLEZ LIRE TOUTES LES INSTRUCTIONS AVANT DE COMMENCER L'ASSEMBLAGE DE CE PRODUIT. LES PIECES SONT LOURDES. POUR EVITER TOUTE BLESSURE ET POUR VOUS ASSURER QUE LE PRODUIT N'EST PAS ENDOMMAGE' PENDANT L'ASSEMBLAGE, NOUS VOUS RECOMMANDONS DE FAIRE APPEL A UNE OU PLUSIEURS AUTRES PERSONNES. EN CAS DE TACHE EXCESSIVE, ESSUYEZ LE FOND DE L'UNITE' AVANT LE PLACEMENT SUR N'IMPORTE QUELLE SURFACE.









**CUIDADO:** FAVOR DE LEER TODAS LAS INSTRUCCIONES ANTES DE ENSAMBLAR SU PRODUCTO, ESTAS. PIEZAS SON PESADAS. PARA PREVENIR HERIDAS PERSONALES Y ASEGURAR QUE SU PRODUCTO NO SEA DAN ADO MIENTRAS ES ENSAMBLADO. SE RECOMIENDA LA ASISTENCIA DE UNA O MAUS PERSONAS.

**WARNING:** PROTECTIVE GLIDE IS PLACED UNDER EACH LEG OF THE FURNITURE TO RESIST SCRATCHES ON FLOOR SURFACE. SOME FLOOR SURFACES CAN BE EXTRA SENSITIVE TO SCRATCHES AND MARKINGS, IF YOU ARE NOT SURE CONSULT WITH YOUR DEALER. AVERTISSEMENT. LES PIEDS DES MEUBLES SONT MUNIS DE PATINS DESTINES A PROTEGER LE PLANCHER. CERTAINS REVETEMENTS DE SOL PEUVENT ETRE TRES FRAGILES. EN CAS DE DOUTE. CONSULTER LE MARCHAND.

## LIST OF PARTS AND HARDWARE/ LISTE DES PIÈCES ET DU MATÉRIEL/ LISTA DE PIEZAS Y HARDWARE

NO#/ NOMBRE/ NÚMERO	DESCRIPTION/ DESCRIPTION/ DESCRIPCIÓN	QUANTITY/ QUANTITÉ/ CANTIDAD
A	STUDS/ STUDS/ LOS ESTUDIOS $\phi 5/16'' \times 4-1/2''$ L 	8 PCS
B	LOCK WASHER "C"/ RONDELLE DE BLOCAGE "C"/ ARANDELA DE BLOQUEO "C" $\phi 5/16'' \times 36 \times 15 \times 3$ mm 	8 PCS
C	NUT/ ÉCROU/ NUEZ $\phi 5/16'' \times 12$ mm 	8 PCS
D	WRENCH/ CLÉ/ LLAVE INGLESA 12mm 	1 PC
E	FLAT WASHER/ RONDELLE PLATE/ ARANDELA PLANA $\phi 5/16'' \times 18 \times 1.5$ mm 	12 PCS
F	LOCK WASHER/ RONDELLE DE BLOCAGE/ ARANDELA DE BLOQUEO $\phi 5/16'' \times 13 \times 1$ mm 	12 PCS
G	BOLT/ BOULON/ TORNILLO $\phi 5/16'' \times 1-1/2''$ L 	12 PCS
H	ALLEN WRENCH/ CLÉ ALLEN/ LLAVE INGLESA ALLEN 4mm 	1 PC
I	SCREW/ VIS/ TORNILLO #4*25 	8 PCS

## LIST OF PARTS AND HARDWARE/ LISTE DES PIÈCES ET DU MATÉRIEL/ LISTA DE PIEZAS Y HARDWARE

NO#/ NOMBRE/ NÚMERO	DESCRIPTION/ DESCRIPTION/ DESCRIPCIÓN	QUANTITY/ QUANTITÉ/ CANTIDAD
1	HEADBOARD/ TÊTE DE LIT/ CABECERA 	1 PC
2	LEG HEADBOARD (LEFT)/ TÊTE DE LIT JAMBE (GAUCHE)/ CABECERA DE PIERNA (IZQUIERDA) 	1 PC
3	LEG HEADBOARD (RIGHT)/ TÊTE DE LIT JAMBE (DROITE)/ CABECERA DE PIERNA (DERECHA) 	1 PC
4	BOTTOM STRETCHER/ RALLONGE DU BAS/ CAMILLA INFERIOR 	1 PC
5	MENDING PLATE/ PLAQUE DE RÉPARATION/ PLACA DE REPARACIÓN 	2 PCS
6	FOOTBOARD/ PIED DE LIT/ ESTRIBO 	1 PC
7	SIDE RAIL/ RAIL LATÉRAL/ CARRIL LATERAL 	2 PCS
8	HORIZONTAL SLATS (1548mm)/ HORIZONTAL LATTES (1548mm)/ HORIZONTAL LISTONES (1548mm) 	4 PCS
9	SLAT SUPPORT (190mm)/ LATTES D'APPUI (190mm)/ LISTONES DE APOYO (190mm) 	4 PCS

**NOTE:**  
ASSEMBLE UNIT ON A SOFT SURFACE.  
ASSEMBLEZ L'UNITÉ SUR UNE SURFACE MOLLE.  
ENSAMBLE LA UNIDAD EN UNA SUPERFICIE PLANA Y SUA VE.

DO NOT TIGHTEN BOLTS UNTIL THE UNIT IS COMPLETELY ASSEMBLED.  
NE SERREZ PAS LES BOULONS JUSQU'À CE QUE L'UNITÉ SOIT COMPLÈTEMENT ASSEMBLÉE.  
NO APRIETE LOS TORNILLOS HASTA QUE LA UNIDAD ESTE COMPLETAMENTE ENSAMBLADA.

# ASSEMBLY INSTRUCTIONS INSTRUCTIONS DE MONTAGE INSTRUCCIONES DE MONTAJE

QUEEN PANEL HEADBOARD  
QUEEN PANEL FOOTBOARD  
QUEEN/KING PANEL BED REGULAR RAILS

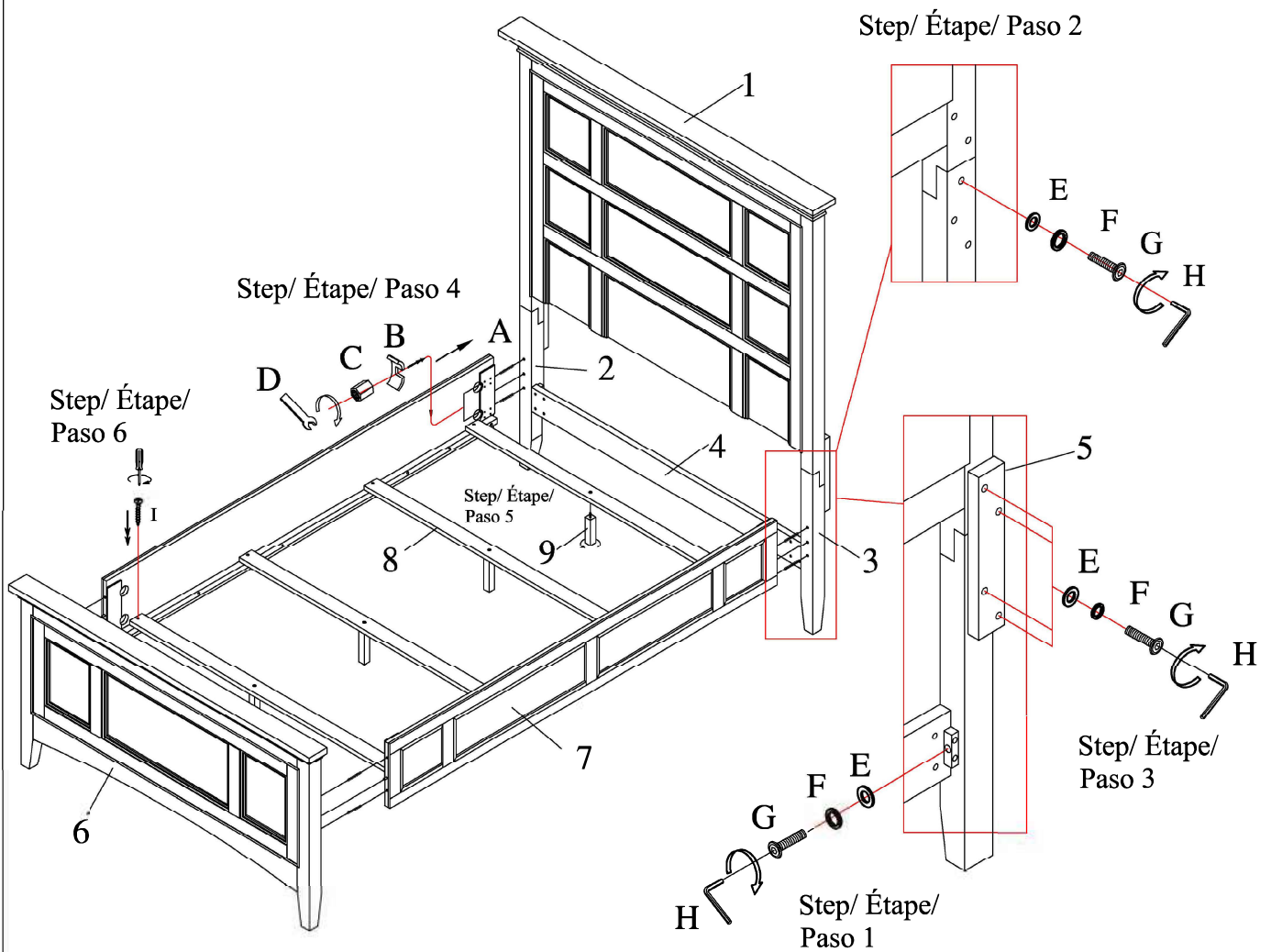
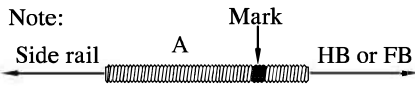

# ASSEMBLY INSTRUCTIONS INSTRUCTIONS DE MONTAGE INSTRUCCIONES DE MONTAJE

QUEEN PANEL HEADBOARD  
QUEEN PANEL FOOTBOARD QUEEN  
PANEL BED STORAGE RAILS









**CAUTION:** PLEASE READ ALL INSTRUCTIONS BEFORE STARTING THE ASSEMBLY OF THIS PRODUCT. THESE PIECES ARE HEAVY. IN ORDER TO PREVENT PERSONAL INJURY AND ENSURE THAT THIS PRODUCT IS NOT DAMAGED DURING THE ASSEMBLY PROCESS, IT IS STRONGLY RECOMMENDED TO ENLIST THE ASSISTANCE OF ONE OR MORE PERSONS. IN CASE OF EXCESS STAIN, WIPE THE BOTTOM OF THE UNIT BEFORE PLACING ON ANY SURFACE.

**ATTENTION:** VEUILLEZ LIRE TOUTES LES INSTRUCTIONS AVANT DE COMMENCER L'ASSEMBLAGE DE CE PRODUIT. LES PIECES SONT LOURDES. POUR EVITER TOUTE BLESSURE ET POUR VOUS ASSURER QUE LE PRODUIT N'EST PAS ENDOMMAGE' PENDANT L'ASSEMBLAGE, NOUS VOUS RECOMMANDONS DE FAIRE APPEL A UNE OU PLUSIEURS AUTRES PERSONNES. EN CAS DE TACHE EXCESSIVE, ESSUYEZ LE FOND DE L'UNITE' AVANT LE PLACEMENT SUR N'IMPORTE QUELLE SURFACE.











**CUIDADO:** FAVOR DE LEER TODAS LAS INSTRUCCIONES ANTES DE ENSAMBLAR SU PRODUCTO, ESTAS. PIEZAS SON PESADAS. PARA PREVENIR HERIDAS PERSONALES Y ASEGURAR QUE SU PRODUCTO NO SEA DAN ADO MIENTRAS ES ENSAMBLADO. SE RECOMIENDA LA ASISTENCIA DE UNA O MAUS PERSONAS.

**WARNING:** PROTECTIVE GLIDE IS PLACED UNDER EACH LEG OF THE FURNITURE TO RESIST SCRATCHES ON FLOOR SURFACE. SOME FLOOR SURFACES CAN BE EXTRA SENSITIVE TO SCRATCHES AND MARKINGS, IF YOU ARE NOT SURE CONSULT WITH YOUR DEALER.  
AVERTISSEMENT. LES PIEDS DES MEUBLES SONT MUNIS DE PATINS DESTINES A PROTEGER LE PLANCHER. CERTAINS REVETEMENTS DE SOL PEUVENT ETRE TRES FRAGILES. EN CAS DE DOUTE. CONSULTER LE MARCHAND.

## LIST OF PARTS AND HARDWARE/ LISTE DES PIÈCES ET DU MATÉRIEL/ LISTA DE PIEZAS Y HARDWARE

NO#/ NOMBRE/ NÚMERO	DESCRIPTION/ DESCRIPTION/ DESCRIPCIÓN	QUANTITY/ QUANTITÉ/ CANTIDAD
A	STUDS/ STUDS/ LOS ESTUDIOS $\phi 5/16" \times 4-1/2" L$ 	8 PCS
B	LOCK WASHER "C"/ RONDELLE DE BLOCAGE "C"/ ARANDELA DE BLOQUEO "C" $\phi 5/16" \times 36 \times 15 \times 3 \text{mm}$ 	8 PCS
C	NUT/ ÉCROU/ NUEZ $\phi 5/16" \times 12 \text{mm}$ 	8 PCS
D	WRENCH/ CLÉ/ LLAVE INGLESA 12mm 	1 PC
E	FLAT WASHER/ RONDELLE PLATE/ ARANDELA PLANA $\phi 5/16" \times 18 \times 1.5 \text{mm}$ 	12 PCS
F	LOCK WASHER/ RONDELLE DE BLOCAGE/ ARANDELA DE BLOQUEO $\phi 5/16" \times 13 \times 1 \text{mm}$ 	12 PCS
G	BOLT/ BOULON/ TORNILLO $\phi 5/16" \times 1-1/2" L$ 	12 PCS
H	ALLEN WRENCH/ CLÉ ALLEN/ LLAVE INGLESA ALLEN 4mm 	1 PC
I	SCREW/ VIS/ TORNILLO #4*25 	24 PCS

## LIST OF PARTS AND HARDWARE/ LISTE DES PIÈCES ET DU MATÉRIEL/ LISTA DE PIEZAS Y HARDWARE

NO#/ NOMBRE/ NÚMERO	DESCRIPTION/ DESCRIPTION/ DESCRIPCIÓN	QUANTITY/ QUANTITÉ/ CANTIDAD
1	HEADBOARD/ TÊTE DE LIT/ CABECERA 	1 PC
2	HEADBOARD LEG (LEFT)/ PATTE DE TÊTE DE LIT (GAUCHE)/ PIERNA DE CABECERA (IZQUIERDA) 	1 PC
3	HEADBOARD LEG (RIGHT)/ PATTE DE TÊTE DE LIT (DROITE)/ PIERNA DE CABECERA (DERECHA) 	1 PC
4	BOTTOM STRETCHER/ RALLONGE DU BAS/ CAMILLA INFERIOR 	1 PC
5	MENDING PLATE/ PLAQUE DE RÉPARATION/ PLACA DE REPARACIÓN 	2 PCS
6	FOOTBOARD/ PIED DE LIT/ ESTRIBO 	1 PC
7	SIDE RAIL/ QUEUE DE LIT/ RAIL LATÉRAL/ CARRIL LATERAL 	2 PCS
8	HORIZONTAL SLATS (1548mm)/ HORIZONTAL LATTES (1548mm)/ HORIZONTAL LISTÓNES (1548mm) 	12 PCS
9	VERTICAL SLATS (915mm)/ VERTICAL LATTES (915mm)/ VERTICAL LISTÓNES (915mm) 	2 PCS
10	SLAT SUPPORT (402mm)/ LATTES D'APPUI (402mm)/ LISTÓNES DE APOYO (402mm) 	4 PCS
11	SUPPORT LEGS (138mm)/ JAMBE D'APPUI (138mm)/ PIERNA DE APOYO (138mm) 	6 PCS

NOTE:  
ASSEMBLE UNIT ON A SOFT SURFACE.  
ASSEMBLEZ L'UNITÉ SUR UNE SURFACE MOLLE.  
ENSAMBLE LA UNIDAD EN UNA SUPERFICIE PLANA Y SUAVE.

DO NOT TIGHTEN BOLTS UNTIL THE UNIT IS COMPLETELY ASSEMBLED.  
NE SERREZ PAS LES BOULONS JUSQU'À CE QUE L'UNITÉ SOIT COMPLÈTEMENT ASSEMBLÉE.  
NO APRIETE LOS TORNILLOS HASTA QUE LA UNIDAD ESTE COMPLETAMENTE ENSAMBLADA.

# ASSEMBLY INSTRUCTIONS INSTRUCTIONS DE MONTAGE INSTRUCCIONES DE MONTAJE

QUEEN PANEL HEADBOARD  
QUEEN PANEL FOOTBOARD QUEEN  
PANEL BED STORAGE RAILS

Note/ Remarque/ nota:

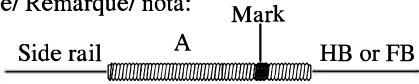

Step/ Étape/ Paso 5

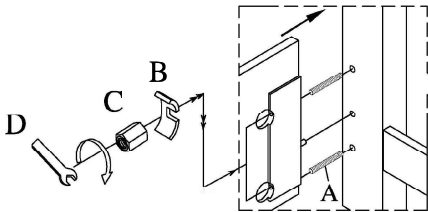

Step/ Étape/ Paso 2

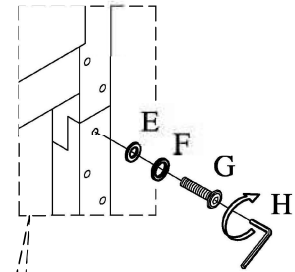

Step/ Étape/ Paso 7

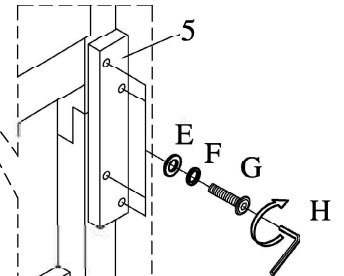
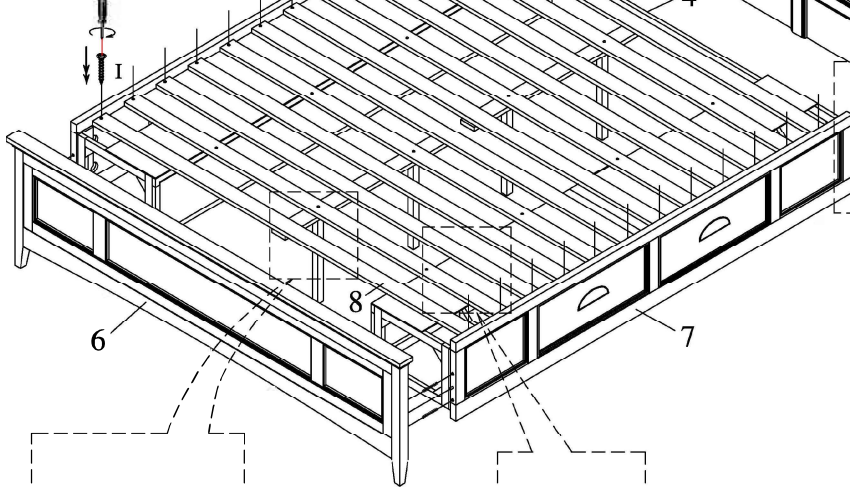

Step/ Étape/  
Paso 3

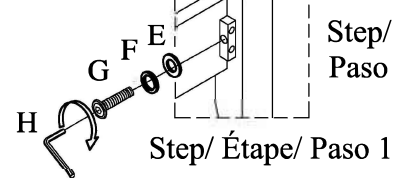

Step/ Étape/ Paso 1

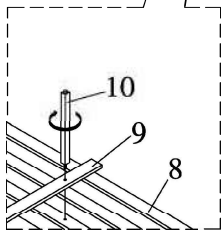

Step/ Étape/ Paso 6

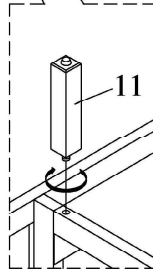

Step/ Étape/ Paso 4

# ASSEMBLY INSTRUCTIONS INSTRUCTIONS DE MONTAGE INSTRUCCIONES DE MONTAJE

KING PANEL HEADBOARD  
KING PANEL FOOTBOARD  
CAL.KING PANEL BED STORAGE RAILS

**CAUTION:** PLEASE READ ALL INSTRUCTIONS BEFORE STARTING THE ASSEMBLY OF THIS PRODUCT. THESE PIECES ARE HEAVY. IN ORDER TO PREVENT PERSONAL INJURY AND ENSURE THAT THIS PRODUCT IS NOT DAMAGED DURING THE ASSEMBLY PROCESS, IT IS STRONGLY RECOMMENDED TO ENLIST THE ASSISTANCE OF ONE OR MORE PERSONS. IN CASE OF EXCESS STAIN, WIPE THE BOTTOM OF THE UNIT BEFORE PLACING ON ANY SURFACE.

**ATTENTION:** VEUILLEZ LIRE TOUTES LES INSTRUCTIONS AVANT DE COMMENCER L'ASSEMBLAGE DE CE PRODUIT. LES PIÈCES SONT LOURDES. POUR ÉVITER TOUTE BLESSURE ET POUR VOUS, ASSURER QUE LE PRODUIT N'EST PAS ENDOMMAGÉ PENDANT L'ASSEMBLAGE, NOUS VOUS RECOMMANDONS DE FAIRE APPEL À UNE OU PLUSIEURS AUTRES PERSONNES. EN CAS DE TACHE EXCESSIVE, ESSUYEZ LE FOND DE L'UNITÉ AVANT LE PLACEMENT SUR N'IMPORTE QUELLE SURFACE.



**CUIDADO:** FAVOR DE LEER TODAS LAS INSTRUCCIONES ANTES DE ENSAMBLAR SU PRODUCTO. ESTAS PIEZAS SON PESADAS. PARA PREVENIR HERIDAS PERSONALES Y ASEGURAR QUE SU PRODUCTO NO SEA DAÑADO MIENTRAS ES ENSAMBLADO. SE RECOMIENDA LA ASISTENCIA DE UNA O MÁS PERSONAS.

**WARNING:** PROTECTIVE GLIDE IS PLACED UNDER EACH LEG OF THE FURNITURE TO RESIST SCRATCHES ON FLOOR SURFACE. SOME FLOOR SURFACES CAN BE EXTRA SENSITIVE TO SCRATCHES AND MARKINGS, IF YOU ARE NOT SURE CONSULT WITH YOUR DEALER. AVERTISSEMENT. LES PIEDS DES MEUBLES SONT MUNIS DE PATINS DESTINÉS À PROTÉGER LE PLANCHER. CERTAINS REVÊTEMENTS DE SOL PEUVENT ÊTRE TRÈS FRAGILES. EN CAS DE DOUTE, CONSULTER LE MARCHAND.

LIST OF PARTS AND HARDWARE (HB/FB)/ LISTE DES PIÈCES ET DU MATÉRIEL (HB/FB)/ LISTA DE PIEZAS Y HARDWARE (HB/FB)			
NO#/ NOMBRE/ NÚMERO	DESCRIPTION/ DESCRIPTION/ DESCRIPCIÓN		QUANTITY/ QUANTITÉ/ CANTIDAD
E	FLAT WASHER/ RONDELLE PLATE/ ARANDELA PLANA	Φ5/16"×18*1.5mm	12 PCS
F	LOCK WASHER/ RONDELLE DE BLOCAGE/ ARANDELA DE BLOQUEO	Φ5/16"×13*1mm	12 PCS
G	BOLT/ BOULON/ TORNILLO	Φ5/16"×1-1/2"L	12 PCS
H	ALLEN WRENCH/ CLÉ ALLEN/ LLAVE INGLESA ALLEN	4mm	1 PC
I	SCREW/ VIS/ TORNILLO	#4*25	8 PCS

LIST OF PARTS AND HARDWARE CAL.KING RAIL/ LISTE DES PIÈCES ET DU MATÉRIEL CAL.KING RAIL/ LISTA DE PIEZAS Y HARDWARE CAL.KING RAIL			
NO#/ NOMBRE/ NÚMERO	DESCRIPTION/ DESCRIPTION/ DESCRIPCIÓN		QUANTITY/ QUANTITÉ/ CANTIDAD
A	STUDS/ STUDS/ LOS ESTUDIOS	Φ5/16"×4-1/2"L	8 PCS
B	LOCK WASHER "C"/ RONDELLE DE BLOCAGE "C"/ ARANDELA DE BLOQUEO "C"	36*15*3mm	8 PCS
C	NUT/ ÉCROU/ NUEZ	Φ5/16"×12mm	8 PCS
D	WRENCH/ CLÉ/ LLAVE INGLESA	12mm	1 PC
L	FLAT WASHER/ RONDELLE PLATE/ ARANDELA PLANA	Φ5/16"×14*1.5mm	10 PCS
F	LOCK WASHER/ RONDELLE DE BLOCAGE/ ARANDELA DE BLOQUEO	Φ5/16"×13*1mm	10 PCS
G	BOLT/ BOULON/ TORNILLO	Φ5/16"×1-1/2"L	10 PCS
H	ALLEN WRENCH/ CLÉ ALLEN/ LLAVE INGLESA ALLEN	4mm	1 PC
I	SCREW/ VIS/ TORNILLO	#4*25	16 PCS

LIST OF PARTS AND HARDWARE/ LISTE DES PIÈCES ET DU MATÉRIEL/ LISTA DE PIEZAS Y HARDWARE			
NO#/ NOMBRE/ NÚMERO	DESCRIPTION/ DESCRIPTION/ DESCRIPCIÓN		QUANTITY/ QUANTITÉ/ CANTIDAD
1	HEADBOARD/ TÊTE DE LIT/ CABECERA		1 PC
2	LEG HEADBOARD (LEFT)/ TÊTE DE LIT JAMBE (GAUCHE)/ CABECERA DE PIERNA (IZQUIERDA)		1 PC
3	LEG HEADBOARD (RIGHT)/ TÊTE DE LIT JAMBE (DROITE)/ CABECERA DE PIERNA (DERECHA)		1 PC
4	BOTTOM STRETCHER/ RALLONGE DU BAS/ CAMILLA INFERIOR		1 PC
5	MENDING PLATE/ PLAQUE DE RÉPARATION/ PLACA DE REPARACIÓN		2 PCS
6	FOOTBOARD/ PIED DE LIT/ ESTRIBO		1 PC
7	SIDE RAIL/ RAIL LATÉRAL/ CARRIL LATERAL		2 PCS
8	SPACE BAR/ BAR D'ESPACE/ BARRA DE ESPACIO		4 PCS
9	HORIZONTAL SLATS (1954mm)/ HORIZONTAL LATTES (1954mm)/ HORIZONTAL LISTONES (1954mm)		12 PCS
10	VERTICAL SLATS (915mm)/ VERTICAL LATTES (915mm)/ VERTICAL LISTONES (915mm)		2 PCS
11	SLAT SUPPORT (402mm)/ LATTES D'APPUI (402mm)/ LISTONES DE APOYO (402mm)		4 PCS
12	SUPPORT LEGS (138mm)/ JAMBE D'APPUI (138mm)/ PIERNA DE APOYO (138mm)		6 PCS

NOTE:  
ASSEMBLE UNIT ON A SOFT SURFACE.  
ASSEMBLEZ L'UNITÉ SUR UNE SURFACE MOLLE.  
ENSAMBLE LA UNIDAD EN UNA SUPERFICIE PLANA Y SUAVE.

DO NOT TIGHTEN BOLTS UNTIL THE UNIT IS COMPLETELY ASSEMBLED.  
NE SERREZ PAS LES BOULONS JUSQU'À CE QUE L'UNITÉ SOIT COMPLÈTEMENT ASSEMBLÉE.  
NO APRIETE LOS TORNILLOS HASTA QUE LA UNIDAD ESTE COMPLETAMENTE ENSAMBLADA.

# ASSEMBLY INSTRUCTIONS INSTRUCTIONS DE MONTAGE INSTRUCCIONES DE MONTAJE

KING PANEL HEADBOARD  
KING PANEL FOOTBOARD  
CAL.KING PANEL BED STORAGE RAILS

Note:

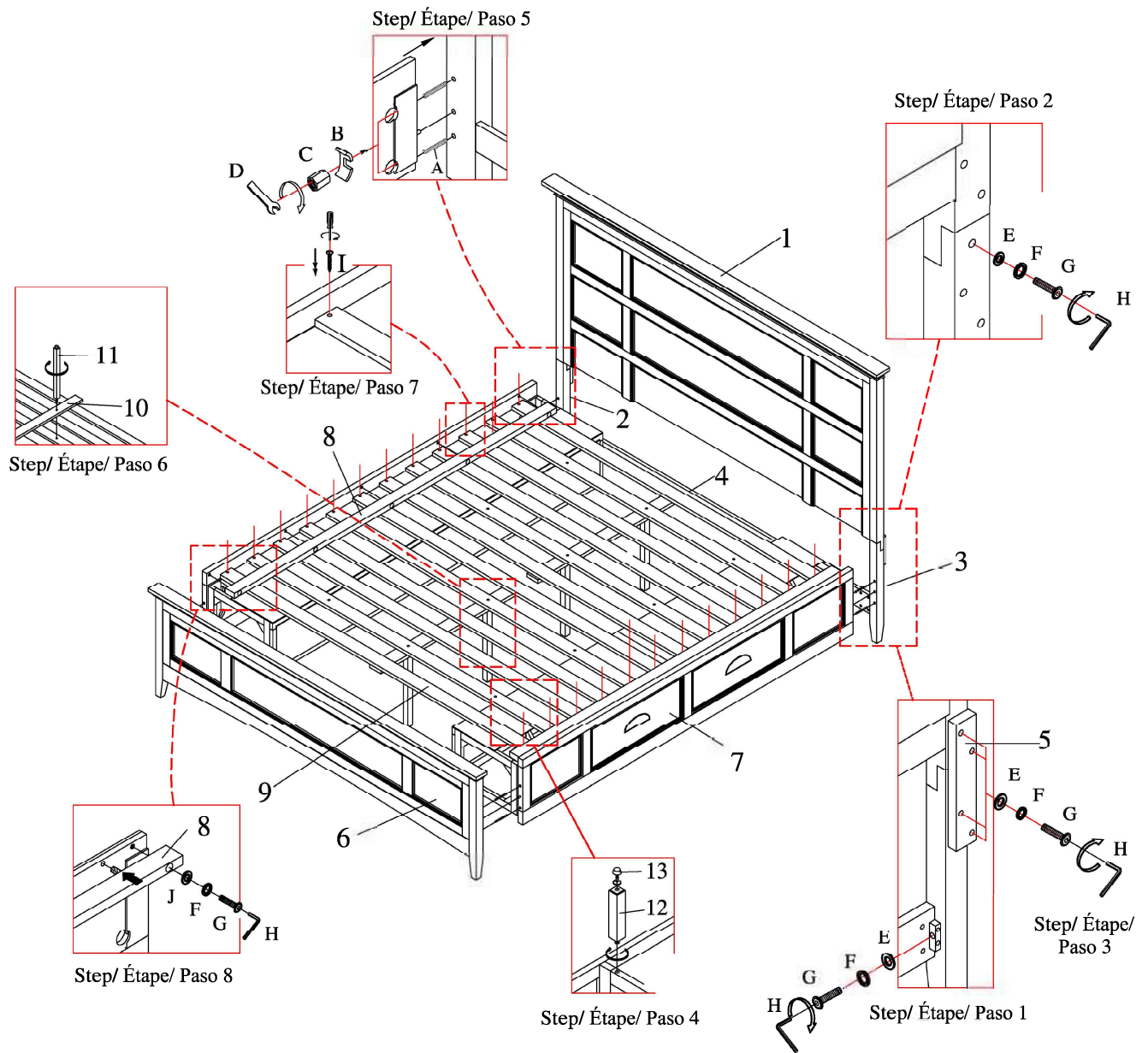
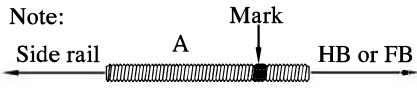

# ASSEMBLY INSTRUCTIONS INSTRUCTIONS DE MONTAGE INSTRUCCIONES DE MONTAJE

KING PANEL HEADBOARD  
KING PANEL FOOTBOARD  
CAL.KING PANEL BED REGULAR RAILS

**CAUTION:** PLEASE READ ALL INSTRUCTIONS BEFORE STARTING THE ASSEMBLY OF THIS PRODUCT. THESE PIECES ARE HEAVY. IN ORDER TO PREVENT PERSONAL INJURY AND ENSURE THAT THIS PRODUCT IS NOT DAMAGED DURING THE ASSEMBLY PROCESS, IT IS STRONGLY RECOMMENDED TO ENLIST THE ASSISTANCE OF ONE OR MORE PERSONS. IN CASE OF EXCESS STAIN, WIPE THE BOTTOM OF THE UNIT BEFORE PLACING ON ANY SURFACE.

**ATTENTION:** VEUILLEZ LIRE TOUTES LES INSTRUCTIONS AVANT DE COMMENCER L'ASSEMBLAGE DE CE PRODUIT. LES PIECES SONT LOURDES. POUR EVITER TOUTE BLESSURE ET POUR VOUS ASSURER QUE LE PRODUIT N'EST PAS ENDOMMAGE' PENDANT L'ASSEMBLAGE, NOUS VOUS RECOMMANDONS DE FAIRE APPEL A UNE OU PLUSIEURS AUTRES PERSONNES. EN CAS DE TACHE EXCESSIVE, ESSUYEZ LE FOND DE L'UNITE' AVANT LE PLACEMENT SUR N'IMPORTE QUELLE SURFACE.











**CUIDADO:** FAVOR DE LEER TODAS LAS INSTRUCCIONES ANTES DE ENSAMBLAR SU PRODUCTO, ESTAS. PIEZAS SON PESADAS. PARA PREVENIR HERIDAS PERSONALES Y ASEGURAR QUE SU PRODUCTO NO SEA DAN ADO MIENTRAS ES ENSAMBLADO. SE RECOMIENDA LA ASISTENCIA DE UNA O MAUS PERSONAS.

**WARNING:** PROTECTIVE GLIDE IS PLACED UNDER EACH LEG OF THE FURNITURE TO RESIST SCRATCHES ON FLOOR SURFACE. SOME FLOOR SURFACES CAN BE EXTRA SENSITIVE TO SCRATCHES AND MARKINGS, IF YOU ARE NOT SURE CONSULT WITH YOUR DEALER.  
AVERTISSEMENT. LES PIEDS DES MEUBLES SONT MUNIS DE PATINS DESTINES A PROTEGER LE PLANCHER. CERTAINS REVETEMENTS DE SOL PEUVENT ETRE TRES FRAGILES. EN CAS DE DOUTE. CONSULTER LE MARCHAND.

LIST OF PARTS AND HARDWARE (HB/FB)/ LISTE DES PIÈCES ET DU MATÉRIEL(HB/FB)/ LISTA DE PIEZAS Y HARDWARE(HB/FB)			
NO#/NOMBRE/NÚMERO	DESCRIPTION/ DESCRIPTION/ DESCRIPCIÓN		QUANTITY/ QUANTITÉ/ CANTIDAD
E	FLAT WASHER/ RONDELLE PLATE/ ARANDELA PLANA	Φ5/16"*18*1.5mm	12 PCS
F	LOCK WASHER/ RONDELLE DE BLOCAGE/ ARANDELA DE BLOQUEO	Φ5/16"*13*1mm	12 PCS
G	BOLT/ BOULON/ TORNILLO	Φ5/16"*1-1/2"L	12 PCS
H	ALLEN WRENCH/ CLÉ ALLEN/ LLAVE INGLESA ALLEN	4mm	1 PC
I	SCREW/ VIS/ TORNILLO	#4*25	8 PCS

LIST OF PARTS AND HARDWARE CAL.KING RAIL/ LISTE DES PIÈCES ET DU MATÉRIEL CAL.KING RAIL/ LISTA DE PIEZAS Y HARDWARE CAL.KING RAIL			
NO#/NOMBRE/NÚMERO	DESCRIPTION/ DESCRIPTION/ DESCRIPCIÓN		QUANTITY/ QUANTITÉ/ CANTIDAD
A	STUDS/ STUDS/ LOS ESTUDIOS	Φ5/16"*4-1/2"L	8 PCS
B	LOCK WASHER "C"/ RONDELLE DE BLOCAGE "C"/ ARANDELA DE BLOQUEO "C"	36*15*3mm	8 PCS
C	NUT/ ÉCROU/ NUEZ	Φ5/16"*12mm	8 PCS
D	WRENCH/ CLÉ/ LLAVE INGLESA	12mm	1 PC
L	FLAT WASHER/ RONDELLE PLATE/ ARANDELA PLANA	Φ5/16"*14*1.5mm	10 PCS
F	LOCK WASHER/ RONDELLE DE BLOCAGE/ ARANDELA DE BLOQUEO	Φ5/16"*13*1mm	10 PCS
G	BOLT/ BOULON/ TORNILLO	Φ5/16"*1-1/2"L	10 PCS
H	ALLEN WRENCH/ CLÉ ALLEN/ LLAVE INGLESA ALLEN	4mm	1 PC

LIST OF PARTS AND HARDWARE/ LISTE DES PIÈCES ET DU MATÉRIEL/ LISTA DE PIEZAS Y HARDWARE			
NO#/NOMBRE/NÚMERO	DESCRIPTION/ DESCRIPTION/ DESCRIPCIÓN		QUANTITY/ QUANTITÉ/ CANTIDAD
1	HEADBOARD/ TÊTE DE LIT/ CABECERA		1 PC
2	HEADBOARD LEG (LEFT)/ PATTE TÊTE DE LIT (GAUCHE)/ PIERNA DE CABECERA (IZQUIERDA)		1 PC
3	HEADBOARD LEG (RIGHT)/ PATTE TÊTE DE LIT (DROITE)/ PIERNA DE CABECERA (DERECHA)		1 PC
4	BOTTOM STRETCHER/ RALLONGE DU BAS/ CAMILLA INFERIOR		1 PC
5	MENDING PLATE/ PLAQUE DE RÉPARATION/ PLACA DE REPARACIÓN		2 PCS
6	FOOTBOARD/ PIED DE LIT/ ESTRIBO		1 PC
7	SIDE RAIL/ RAIL LATÉRAL/ CARRIL LATERAL		2 PCS
8	SPACE BAR/ BAR D'ESPACE/ BARRA DE ESPACIO		4 PCS
9	SLATS (1954mm)/ LATTES (1954mm)/ LISTONES (1954mm)		4 PCS
10	SLAT SUPPORT (190mm)/ LATTES D'APPUI (190mm)/ LISTONES DE APOYO (190mm)		12 PCS

NOTE:  
ASSEMBLE UNIT ON A SOFT SURFACE.  
ASSEMBLEZ L'UNITÉ SUR UNE SURFACE MOLLE.  
ENSAMBLE LA UNIDAD EN UNA SUPERFICIE PLANA Y SUAVE.

DO NOT TIGHTEN BOLTS UNTIL THE UNIT IS COMPLETELY ASSEMBLED.  
NE SERREZ PAS LES BOULONS JUSQU'À CE QUE L'UNITÉ SOIT COMPLÈTEMENT ASSEMBLÉE.  
NO APRIETE LOS TORNILLOS HASTA QUE LA UNIDAD ESTE COMPLETAMENTE ENSAMBLADA.

# ASSEMBLY INSTRUCTIONS INSTRUCTIONS DE MONTAGE INSTRUCCIONES DE MONTAJE

KING PANEL HEADBOARD  
KING PANEL FOOTBOARD  
CAL.KING PANEL BED REGULAR RAILS

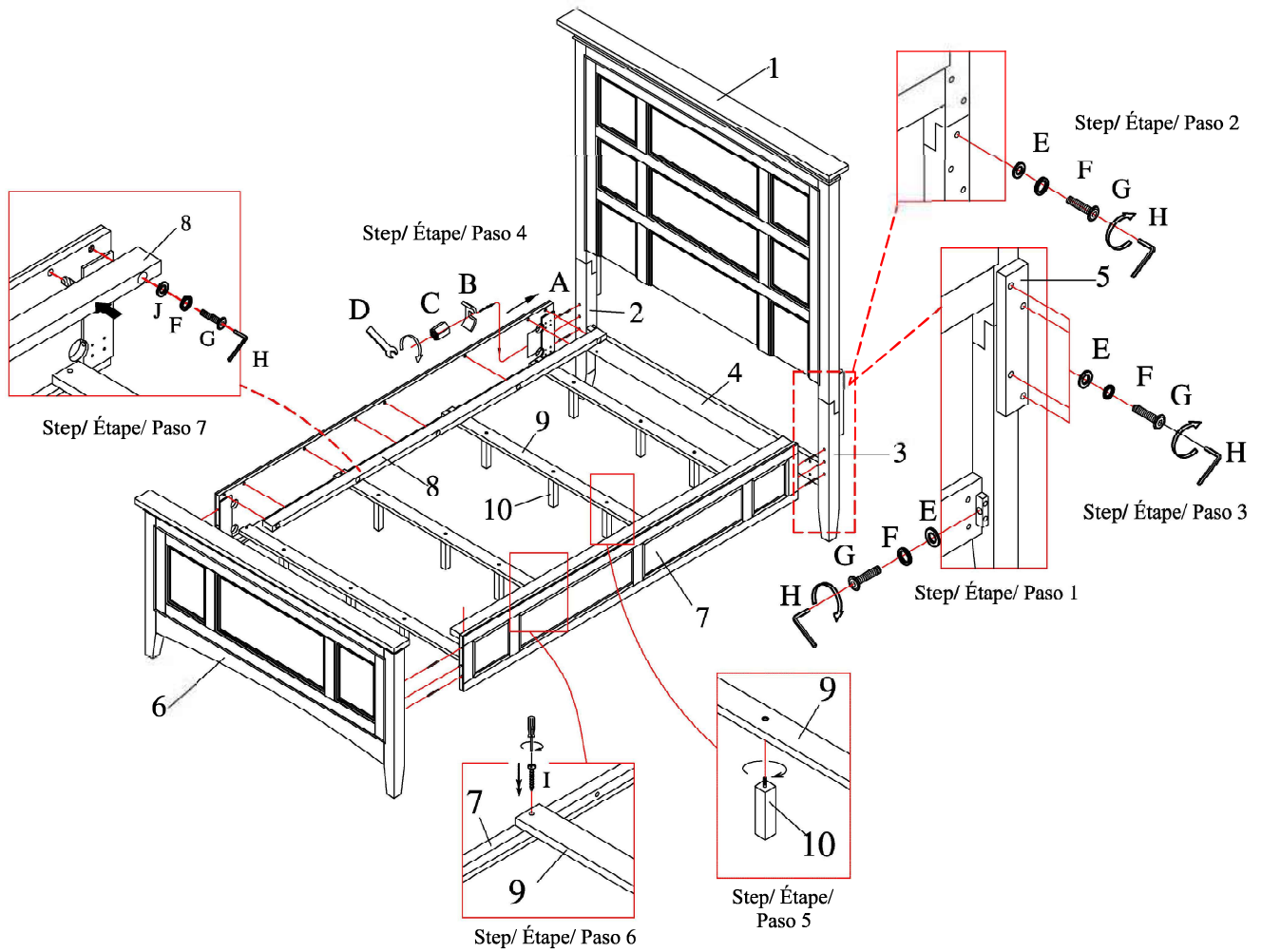
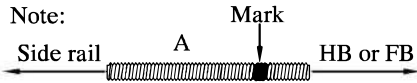

# ASSEMBLY INSTRUCTIONS INSTRUCTIONS DE MONTAGE INSTRUCCIONES DE MONTAJE

## WOOD DRAWER NIGHTSTAND SU

**CAUTION:** PLEASE READ ALL INSTRUCTIONS BEFORE STARTING THE ASSEMBLY OF THIS PRODUCT. THESE PIECES ARE HEAVY. IN ORDER TO PREVENT PERSONAL INJURY AND ENSURE THAT THIS PRODUCT IS NOT DAMAGED DURING THE ASSEMBLY PROCESS, IT IS STRONGLY RECOMMENDED TO ENLIST THE ASSISTANCE OF ONE OR MORE PERSONS. IN CASE OF EXCESS STAIN, WIPE THE BOTTOM OF THE UNIT BEFORE PLACING ON ANY SURFACE.

**ATTENTION:** VEUILLEZ LIRE TOUTES LES INSTRUCTIONS AVANT DE COMMENCER L'ASSEMBLAGE DE CE PRODUIT. LES PIÈCES SONT LOURDES. POUR EVITER TOUTE BLESSURE ET POUR VOUS, ASSURER QUE LE PRODUIT N'EST PAS ENDOMMAGÉ PENDANT L'ASSEMBLAGE, NOUS VOUS RECOMMANDONS DE FAIRE APPEL A UNE OU PLUSIEURS AUTRES PERSONNES. EN CAS DE TACHE EXCESSIVE, ESSUYEZ LE FOND DE L'UNITÉ AVANT LE PLACEMENT SUR N'IMPORTE QUELLE SURFACE.

**CUIDADO:** FAVOR DE LEER TODAS LAS INSTRUCCIONES ANTES DE ENSAMBLAR SU PRODUCTO, ESTAS. PIEZAS SON PESADAS. PARA PREVENIR HERIDAS PERSONALES Y ASEGURAR QUE SU PRODUCTO NO SEA DANADO MIENTRAS ES ENSAMBLADO. SE RECOMIENDA LA ASISTENCIA DE UNA O MAS PERSONAS.

**WARNING:** PROTECTIVE GLIDE IS PLACED UNDER EACH LEG OF THE FURNITURE TO RESIST SCRATCHES ON FLOOR SURFACE. SOME FLOOR SURFACES CAN BE EXTRA SENSITIVE TO SCRATCHES AND MARKINGS, IF YOU ARE NOT SURE CONSULT WITH YOUR DEALER.  
AVERTISSEMENT. LES PIEDS DES MEUBLES SONT MUNIS DE PATINS DESTINES A PROTEGER LE PLANCHER. CERTAINS REVETEMENTS DE SOL PEUVENT ETRE TRES FRAGILES. EN CAS DE DOUTE. CONSULTER LE MARCHAND.

### LIST OF PARTS AND HARDWARE/ LISTE DES PIÈCES ET DU MATÉRIEL/ LISTA DE PIEZAS Y HARDWARE

NO#/ NOMBRE/ NÚMERO	DESCRIPTION/ DESCRIPTION/ DESCRIPCIÓN	QUANTITY/ QUANTITÉ/ CANTIDAD
1	DRAWER NIGHTSTAND/ CABINET / GABINETE	1 PC
2	TILT KIT BRACKET/ SAC ANTI-CHUTE/ BOLSO ANTICAÍDA	1 PC

**NOTE:**  
ASSEMBLE UNIT ON A SOFT SURFACE.  
ASSEMBLEZ L'UNITÉ SUR UNE SURFACE MOLLE.  
ENSAMBLE LA UNIDAD EN UNA SUPERFICIE PLANA Y SUAVE.

**DO NOT TIGHTEN BOLTS UNTIL THE UNIT IS COMPLETELY ASSEMBLED.**  
NE SERREZ PAS LES BOULONS JUSQU'À CE QUE L'UNITÉ SOIT COMPLÈTEMENT ASSEMBLÉE.  
NO APRIETE LOS TORNILLOS HASTA QUE LA UNIDAD ESTE COMPLETAMENTE ENSAMBLADA.

ASSEMBLY INSTRUCTIONS  
INSTRUCTIONS DE MONTAGE  
INSTRUCCIONES DE MONTAJE

WOOD DRAWER NIGHTSTAND SU

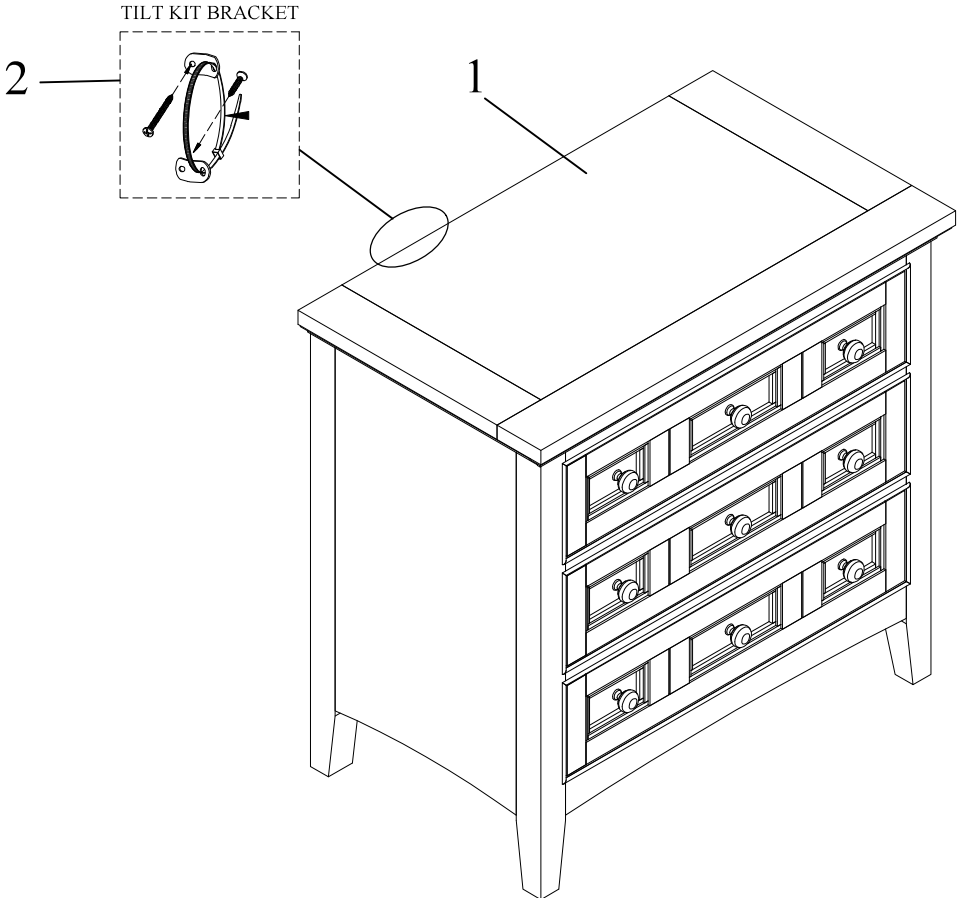

# ASSEMBLY INSTRUCTIONS INSTRUCTIONS DE MONTAGE INSTRUCCIONES DE MONTAJE

## WOOD SMALL DRAWER NIGHTSTAND SU

**CAUTION:** PLEASE READ ALL INSTRUCTIONS BEFORE STARTING THE ASSEMBLY OF THIS PRODUCT. THESE PIECES ARE HEAVY. IN ORDER TO PREVENT PERSONAL INJURY AND ENSURE THAT THIS PRODUCT IS NOT DAMAGED DURING THE ASSEMBLY PROCESS, IT IS STRONGLY RECOMMENDED TO ENLIST THE ASSISTANCE OF ONE OR MORE PERSONS. IN CASE OF EXCESS STAIN, WIPE THE BOTTOM OF THE UNIT BEFORE PLACING ON ANY SURFACE.

**ATTENTION:** VEUILLEZ LIRE TOUTES LES INSTRUCTIONS AVANT DE COMMENCER L'ASSEMBLAGE DE CE PRODUIT. LES PIÈCES SONT LOURDES. POUR ÉVITER TOUTE BLESSURE ET POUR VOUS, ASSURER QUE LE PRODUIT N'EST PAS ENDOMMAGÉ PENDANT L'ASSEMBLAGE, NOUS VOUS RECOMMANDONS DE FAIRE APPEL À UNE OU PLUSIEURS AUTRES PERSONNES. EN CAS DE TACHE EXCESSIVE, ESSUYEZ LE FOND DE L'UNITÉ AVANT LE PLACEMENT SUR N'IMPORTE QUELLE SURFACE.

**CUIDADO:** FAVOR DE LEER TODAS LAS INSTRUCCIONES ANTES DE ENSAMBLAR SU PRODUCTO, ESTAS. PIEZAS SON PESADAS. PARA PREVENIR HERIDAS PERSONALES Y ASEGURAR QUE SU PRODUCTO NO SEA DANADO MIENTRAS ES ENSAMBLADO. SE RECOMIENDA LA ASISTENCIA DE UNA O MAS PERSONAS.

**WARNING:** PROTECTIVE GLIDE IS PLACED UNDER EACH LEG OF THE FURNITURE TO RESIST SCRATCHES ON FLOOR SURFACE. SOME FLOOR SURFACES CAN BE EXTRA SENSITIVE TO SCRATCHES AND MARKINGS, IF YOU ARE NOT SURE CONSULT WITH YOUR DEALER. AVERTISSEMENT. LES PIEDS DES MEUBLES SONT MUNIS DE PATINS DESTINÉS À PROTÉGER LE PLANCHER. CERTAINS REVÊTEMENTS DE SOL PEUVENT ÊTRE TRÈS FRAGILES. EN CAS DE DOUTE. CONSULTER LE MARCHAND.

### LIST OF PARTS AND HARDWARE/ LISTE DES PIÈCES ET DU MATÉRIEL/ LISTA DE PIEZAS Y HARDWARE

NO#/ NOMBRE/ NÚMERO	DESCRIPTION/ DESCRIPTION/ DESCRIPCIÓN	QUANTITY/ QUANTITÉ/ CANTIDAD
1	DRAWER NIGHTSTAND/ CABINET / GABINETE	1 PC
2	TILT KIT BRACKET/ SAC ANTI-CHUTE/ BOLSO ANTICAÍDA	1 PC

**NOTE:**  
ASSEMBLE UNIT ON A SOFT SURFACE.  
ASSEMBLEZ L'UNITÉ SUR UNE SURFACE MOLLE.  
ENSAMBLE LA UNIDAD EN UNA SUPERFICIE PLANA Y SUAVE.

**DO NOT TIGHTEN BOLTS UNTIL THE UNIT IS COMPLETELY ASSEMBLED.**  
**NE SERREZ PAS LES BOULONS JUSQU'À CE QUE L'UNITÉ SOIT COMPLÈTEMENT ASSEMBLÉE.**  
**NO APRIETE LOS TORNILLOS HASTA QUE LA UNIDAD ESTE COMPLETAMENTE ENSAMBLADA.**

ASSEMBLY INSTRUCTIONS  
INSTRUCTIONS DE MONTAGE  
INSTRUCCIONES DE MONTAJE

WOOD SMALL DRAWER NIGHTSTAND SU

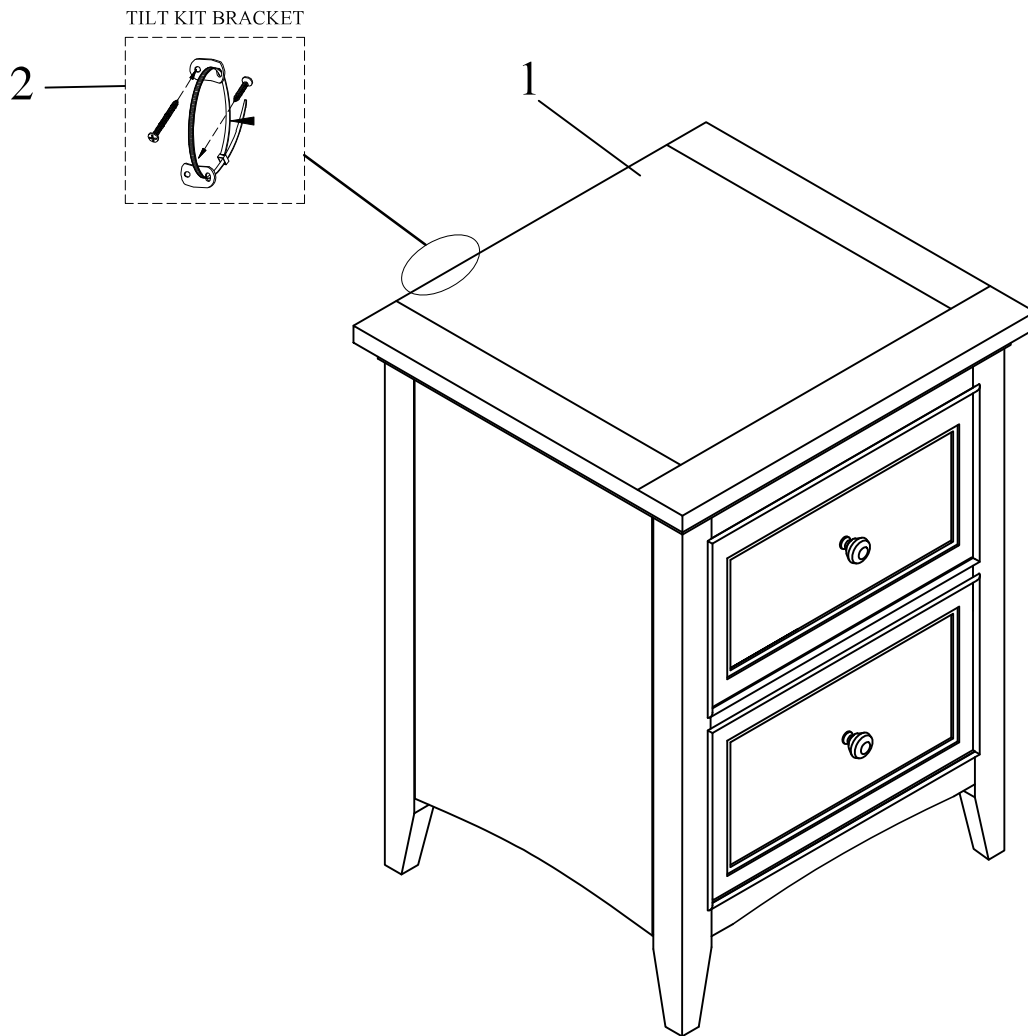

# ASSEMBLY INSTRUCTIONS INSTRUCTIONS DE MONTAGE INSTRUCCIONES DE MONTAJE

## WOOD DRAWER CHEST SU

**CAUTION:** PLEASE READ ALL INSTRUCTIONS BEFORE STARTING THE ASSEMBLY OF THIS PRODUCT. THESE PIECES ARE HEAVY. IN ORDER TO PREVENT PERSONAL INJURY AND ENSURE THAT THIS PRODUCT IS NOT DAMAGED DURING THE ASSEMBLY PROCESS, IT IS STRONGLY RECOMMENDED TO ENLIST THE ASSISTANCE OF ONE OR MORE PERSONS. IN CASE OF EXCESS STAIN, WIPE THE BOTTOM OF THE UNIT BEFORE PLACING ON ANY SURFACE.

**ATTENTION:** VEUILLEZ LIRE TOUTES LES INSTRUCTIONS AVANT DE COMMENCER L'ASSEMBLAGE DE CE PRODUIT. LES PIÈCES SONT LOURDES. POUR EVITER TOUTE BLESSURE ET POUR VOUS ASSURER QUE LE PRODUIT N'EST PAS ENDOMMAGÉ PENDANT L'ASSEMBLAGE, NOUS VOUS RECOMMANDONS DE FAIRE APPEL A UNE OU PLUSIEURS AUTRES PERSONNES. EN CAS DE TACHE EXCESSIVE, ESSUYEZ LE FOND DE L'UNITÉ AVANT LE PLACEMENT SUR N'IMPORTE QUELLE SURFACE.

**CUIDADO:** FAVOR DE LEER TODAS LAS INSTRUCCIONES ANTES DE ENSAMBLAR SU PRODUCTO, ESTAS PIEZAS SON PESADAS. PARA PREVENIR HERIDAS PERSONALES Y ASEGURAR QUE SU PRODUCTO NO SEA DANADO MIENTRAS ES ENSAMBLADO. SE RECOMIENDA LA ASISTENCIA DE UNA O MAS PERSONAS.

**WARNING:** PROTECTIVE GLIDE IS PLACED UNDER EACH LEG OF THE FURNITURE TO RESIST SCRATCHES ON FLOOR SURFACE. SOME FLOOR SURFACES CAN BE EXTRA SENSITIVE TO SCRATCHES AND MARKINGS, IF YOU ARE NOT SURE CONSULT WITH YOUR DEALER. AVERTISSEMENT. LES PIEDS DES MEUBLES SONT MUNIS DE PATINS DESTINES A PROTEGER LE PLANCHER. CERTAINS REVETEMENTS DE SOL PEUVENT ETRE TRES FRAGILES. EN CAS DE DOUTE. CONSULTER LE MARCHAND.

### LIST OF PARTS AND HARDWARE/ LISTE DES PIÈCES ET DU MATÉRIEL/ LISTA DE PIEZAS Y HARDWARE

NO#/ NOMBRE/ NÚMERO	DESCRIPTION/ DESCRIPTION/ DESCRIPCIÓN	QUANTITY/ QUANTITÉ/ CANTIDAD
1	DRAWER CHEST/ CABINET / GABINETE	1 PC
2	TILT KIT BRACKET/ SAC ANTI-CHUTE/ BOLSO ANTICAÍDA	1 PC

**NOTE:**

ASSEMBLE UNIT ON A SOFT SURFACE.

ASSEMBLEZ L'UNITÉ SUR UNE SURFACE MOLLE.

ENSAMBLE LA UNIDAD EN UNA SUPERFICIE PLANA Y SUAVE.

DO NOT TIGHTEN BOLTS UNTIL THE UNIT IS COMPLETELY ASSEMBLED.

NE SERREZ PAS LES BOULONS JUSQU'À CE QUE L'UNITÉ SOIT COMPLÈTEMENT ASSEMBLÉE.

NO APRIETE LOS TORNILLOS HASTA QUE LA UNIDAD ESTE COMPLETAMENTE ENSAMBLADA.

# ASSEMBLY INSTRUCTIONS INSTRUCTIONS DE MONTAGE INSTRUCCIONES DE MONTAJE

## WOOD DRAWER CHEST SU

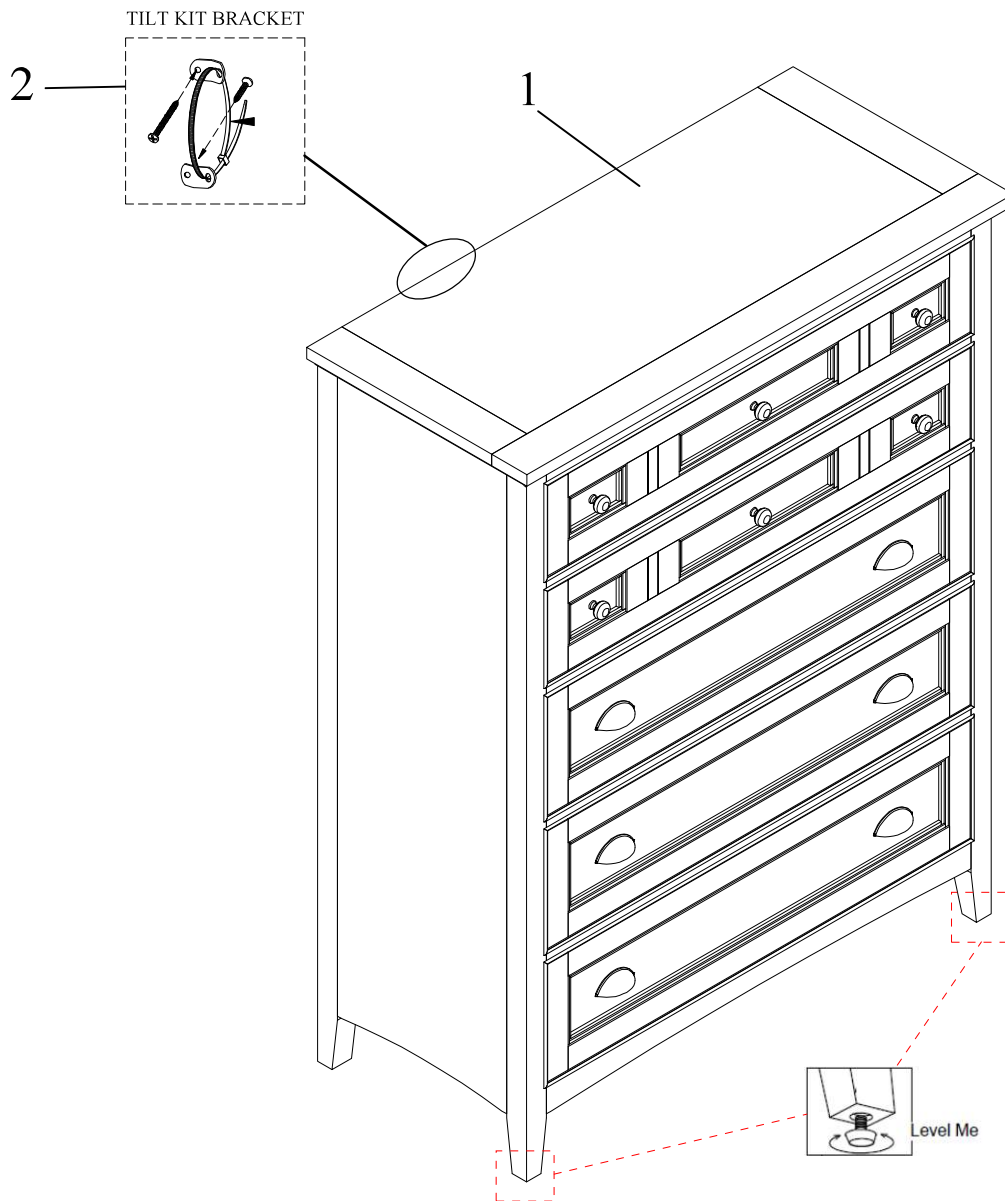

# ASSEMBLY INSTRUCTIONS INSTRUCTIONS DE MONTAGE INSTRUCCIONES DE MONTAJE

## DOOR CHEST

**CAUTION:** PLEASE READ ALL INSTRUCTIONS BEFORE STARTING THE ASSEMBLY OF THIS PRODUCT. THESE PIECES ARE HEAVY. IN ORDER TO PREVENT PERSONAL INJURY AND ENSURE THAT THIS PRODUCT IS NOT DAMAGED DURING THE ASSEMBLY PROCESS, IT IS STRONGLY RECOMMENDED TO ENLIST THE ASSISTANCE OF ONE OR MORE PERSONS. IN CASE OF EXCESS STAIN, WIPE THE BOTTOM OF THE UNIT BEFORE PLACING ON ANY SURFACE.

**ATTENTION:** VEUILLEZ LIRE TOUTES LES INSTRUCTIONS AVANT DE COMMENCER L'ASSEMBLAGE DE CE PRODUIT. LES PIECES SONT LOURDES. POUR EVITER TOUTE BLESSURE ET POUR VOUS ASSURER QUE LE PRODUIT N'EST PAS ENDOMMAGE' PENDANT L'ASSEMBLAGE, NOUS VOUS RECOMMANDONS DE FAIRE APPEL A UNE OU PLUSIEURS AUTRES PERSONNES. EN CAS DE TACHE EXCESSIVE, ESSUYEZ LE FOND DE L'UNITE' AVANT LE PLACEMENT SUR N'IMPORTE QUELLE SURFACE.



**CUIDADO:** FAVOR DE LEER TODAS LAS INSTRUCCIONES ANTES DE ENSAMBLAR SU PRODUCTO, ESTAS. PIEZAS SON PESADAS. PARA PREVENIR HERIDAS PERSONALES Y ASEGURAR QUE SU PRODUCTO NO SEA DAN ADO MIENTRAS ES ENSAMBLADO. SE RECOMIENDA LA ASISTENCIA DE UNA O MAUS PERSONAS.

**WARNING:** PROTECTIVE GLIDE IS PLACED UNDER EACH LEG OF THE FURNITURE TO RESIST SCRATCHES ON FLOOR SURFACE. SOME FLOOR SURFACES CAN BE EXTRA SENSITIVE TO SCRATCHES AND MARKINGS, IF YOU ARE NOT SURE CONSULT WITH YOUR DEALER.  
AVERTISSEMENT. LES PIEDS DES MEUBLES SONT MUNIS DE PATINS DESTINES A PROTEGER LE PLANCHER. CERTAINS REVETEMENTS DE SOL PEUVENT ETRE TRES FRAGILES. EN CAS DE DOUTE. CONSULTER LE MARCHAND.

### LIST OF PARTS AND HARDWARE/ LISTE DES PIÈCES ET DU MATÉRIEL/ LISTA DE PIEZAS Y HARDWARE

NO#/ NOMBRE/ NÚMERO	DESCRIPTION/ DESCRIPTION/ DESCRIPCIÓN		QUANTITY/ QUANTITÉ/ CANTIDAD
A			
B			
C			
D			

### LIST OF PARTS AND HARDWARE/ LISTE DES PIÈCES ET DU MATÉRIEL/ LISTA DE PIEZAS Y HARDWARE

NO#/ NOMBRE/ NÚMERO	DESCRIPTION/ DESCRIPTION/ DESCRIPCIÓN		QUANTITY/ QUANTITÉ/ CANTIDAD
1	CASE/INFERIEUR/ INFERIOR		1 PC
2	DOOR PANEL/PANNEAU DE PORTE/PANEL DE LA PUERTA		1 PC
3	TILT KIT BRACKET/ SUPPORT DE KIT D'INCLINAISON/ SOPORTE KIT INCLINACIÓN		1 PC

NOTE:  
ASSEMBLE UNIT ON A SOFT SURFACE.  
ASSEMBLEZ L'UNITÉ SUR UNE SURFACE MOLLE.  
ENSAMBLE LA UNIDAD EN UNA SUPERFICIE PLANA Y SUAVE.

DO NOT TIGHTEN BOLTS UNTIL **ALL PARTS AND HARDWARE OF** THE UNIT ARE ASSEMBLED.  
NE SERREZ PAS LES BOULONS JUSQU'À CE QUE L'UNITÉ SOIT COMPLÈTEMENT ASSEMBLÉE.  
NO APRIETE LOS TORNILLOS HASTA QUE LA UNIDAD ESTE COMPLETAMENTE ENSAMBLADA.

# ASSEMBLY INSTRUCTIONS INSTRUCTIONS DE MONTAGE INSTRUCCIONES DE MONTAJE

## DOOR CHEST

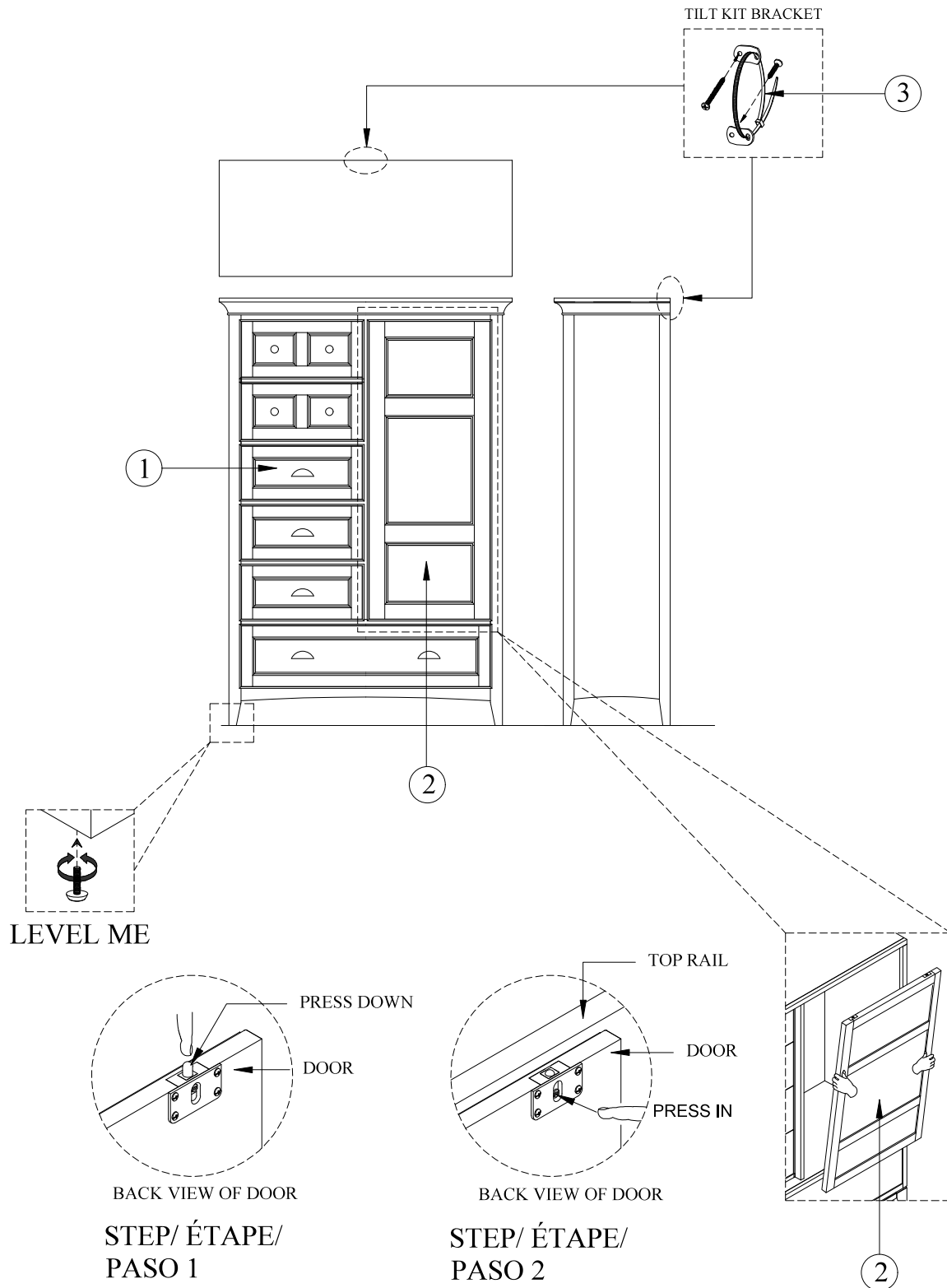

# ASSEMBLY INSTRUCTIONS INSTRUCTIONS DE MONTAGE INSTRUCCIONES DE MONTAJE

## WOOD DRAWER DRESSER



**CAUTION:** PLEASE READ ALL INSTRUCTIONS BEFORE STARTING THE ASSEMBLY OF THIS PRODUCT. THESE PIECES ARE HEAVY. IN ORDER TO PREVENT PERSONAL INJURY AND ENSURE THAT THIS PRODUCT IS NOT DAMAGED DURING THE ASSEMBLY PROCESS, IT IS STRONGLY RECOMMENDED TO ENLIST THE ASSISTANCE OF ONE OR MORE PERSONS. IN CASE OF EXCESS STAIN, WIPE THE BOTTOM OF THE UNIT BEFORE PLACING ON ANY SURFACE.

**ATTENTION:** VEUILLEZ LIRE TOUTES LES INSTRUCTIONS AVANT DE COMMENCER L'ASSEMBLAGE DE CE PRODUIT. LES PIECES SONT LOURDES. POUR EVITER TOUTE BLESSURE ET POUR VOUS, ASSURER QUE LE PRODUIT N'EST PAS ENDOMMAGE' PENDANT L'ASSEMBLAGE, NOUS VOUS RECOMMANDONS DE FAIRE APPEL A UNE OU PLUSIEURS AUTRES PERSONNES. EN CAS DE TACHE EXCESSIVE, ESSUYEZ LE FOND DE L'UNITE' AVANT LE PLACEMENT SUR N'IMPORTE QUELLE SURFACE.

**CUIDADO:** FAVOR DE LEER TODAS LAS INSTRUCCIONES ANTES DE ENSAMBLAR SU PRODUCTO, ESTAS. PIEZAS SON PESADAS. PARA PREVENIR HERIDAS PERSONALES Y ASEGURAR QUE SU PRODUCTO NO SEA DAN ADO MIENTRAS ES ENSAMBLADO. SE RECOMIENDA LA ASISTENCIA DE UNA O MAUS PERSONAS.

**WARNING:** PROTECTIVE GLIDE IS PLACED UNDER EACH LEG OF THE FURNITURE TO RESIST SCRATCHES ON FLOOR SURFACE. SOME FLOOR SURFACES CAN BE EXTRA SENSITIVE TO SCRATCHES AND MARKINGS, IF YOU ARE NOT SURE CONSULT WITH YOUR DEALER.  
AVERTISSEMENT. LES PIEDS DES MEUBLES SONT MUNIS DE PATINS DESTINES A PROTEGER LE PLANCHER. CERTAINS REVETEMENTS DE SOL PEUVENT ETRE TRES FRAGILES. EN CAS DE DOUTE. CONSULTER LE MARCHAND.

### LIST OF PARTS AND HARDWARE/ LISTE DES PIÈCES ET DU MATÉRIEL/ LISTA DE PIEZAS Y HARDWARE

NO#/ NOMBRE/ NÚMERO	DESCRIPTION/ DESCRIPTION/ DESCRIPCIÓN	QUANTITY/ QUANTITÉ/ CANTIDAD
1	TOP DRESSER/ TOP DRESSER/ APARADOR SUPERIOR 	1 PC
2	TILT KIT BRACKET/ SAC ANTI-CHUTE/ BOLSO ANTICAÍDA 	1 PC

NOTE:  
ASSEMBLE UNIT ON A SOFT SURFACE.  
ASSEMBLEZ L'UNITÉ SUR UNE SURFACE MOLLE.  
ENSAMBLE LA UNIDAD EN UNA SUPERFICIE PLANA Y SUAVE.

DO NOT TIGHTEN BOLTS UNTIL THE UNIT IS COMPLETELY ASSEMBLED.  
NE SERREZ PAS LES BOULONS JUSQU'À CE QUE L'UNITÉ SOIT COMPLÈTEMENT ASSEMBLÉE.  
NO APRIETE LOS TORNILLOS HASTA QUE LA UNIDAD ESTE COMPLETAMENTE ENSAMBLADA.

ASSEMBLY INSTRUCTIONS  
INSTRUCTIONS DE MONTAGE  
INSTRUCCIONES DE MONTAJE

WOOD DRAWER DRESSER

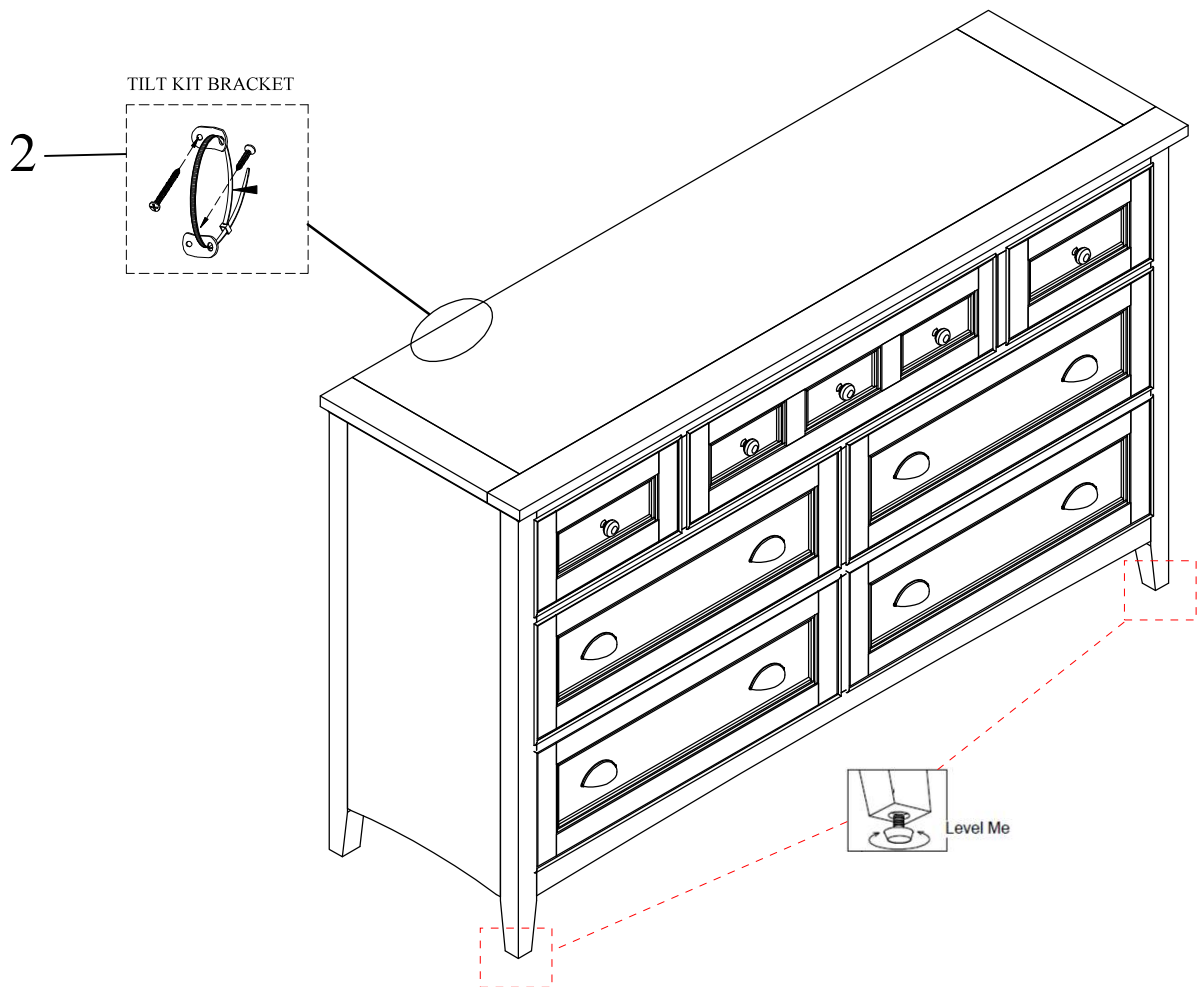

# ASSEMBLY INSTRUCTIONS INSTRUCTIONS DE MONTAGE INSTRUCCIONES DE MONTAJE

## WOOD MEDIA CHEST SU

**CAUTION:** PLEASE READ ALL INSTRUCTIONS BEFORE STARTING THE ASSEMBLY OF THIS PRODUCT. THESE PIECES ARE HEAVY. IN ORDER TO PREVENT PERSONAL INJURY AND ENSURE THAT THIS PRODUCT IS NOT DAMAGED DURING THE ASSEMBLY PROCESS, IT IS STRONGLY RECOMMENDED TO ENLIST THE ASSISTANCE OF ONE OR MORE PERSONS. IN CASE OF EXCESS STAIN, WIPE THE BOTTOM OF THE UNIT BEFORE PLACING ON ANY SURFACE.

**ATTENTION:** VEUILLEZ LIRE TOUTES LES INSTRUCTIONS AVANT DE COMMENCER L'ASSEMBLAGE DE CE PRODUIT. LES PIÈCES SONT LOURDES. POUR EVITER TOUTE BLESSURE ET POUR VOUS, ASSURER QUE LE PRODUIT N'EST PAS ENDOMMAGÉ PENDANT L'ASSEMBLAGE, NOUS VOUS RECOMMANDONS DE FAIRE APPEL A UNE OU PLUSIEURS AUTRES PERSONNES. EN CAS DE TACHE EXCESSIVE, ESSUYEZ LE FOND DE L'UNITÉ AVANT LE PLACEMENT SUR N'IMPORTE QUELLE SURFACE.

**CUIDADO:** FAVOR DE LEER TODAS LAS INSTRUCCIONES ANTES DE ENSAMBLAR SU PRODUCTO, ESTAS. PIEZAS SON PESADAS. PARA PREVENIR HERIDAS PERSONALES Y ASEGURAR QUE SU PRODUCTO NO SEA DANADO MIENTRAS ES ENSAMBLADO. SE RECOMIENDA LA ASISTENCIA DE UNA O MAS PERSONAS.

**WARNING:** PROTECTIVE GLIDE IS PLACED UNDER EACH LEG OF THE FURNITURE TO RESIST SCRATCHES ON FLOOR SURFACE. SOME FLOOR SURFACES CAN BE EXTRA SENSITIVE TO SCRATCHES AND MARKINGS, IF YOU ARE NOT SURE CONSULT WITH YOUR DEALER.  
AVERTISSEMENT. LES PIEDS DES MEUBLES SONT MUNIS DE PATINS DESTINES A PROTEGER LE PLANCHER. CERTAINS REVETEMENTS DE SOL PEUVENT ETRE TRES FRAGILES. EN CAS DE DOUTE. CONSULTER LE MARCHAND.

### LIST OF PARTS AND HARDWARE/ LISTE DES PIÈCES ET DU MATÉRIEL/ LISTA DE PIEZAS Y HARDWARE

NO#/ NOMBRE/ NÚMERO	DESCRIPTION/ DESCRIPTION/ DESCRIPCIÓN	QUANTITY/ QUANTITÉ/ CANTIDAD
1	MEDIA CHEST/ CABINET / GABINETE	1 PC
2	TILT KIT BRACKET/ SAC ANTI-CHUTE/ BOLSO ANTICAÍDA	1 PC

**NOTE:**

ASSEMBLE UNIT ON A SOFT SURFACE.

ASSEMBLEZ L'UNITÉ SUR UNE SURFACE MOLLE.

ENSAMBLE LA UNIDAD EN UNA SUPERFICIE PLANA Y SUAVE.

DO NOT TIGHTEN BOLTS UNTIL THE UNIT IS COMPLETELY ASSEMBLED.

NE SERREZ PAS LES BOULONS JUSQU'À CE QUE L'UNITÉ SOIT COMPLÈTEMENT ASSEMBLÉE.

NO APRIETE LOS TORNILLOS HASTA QUE LA UNIDAD ESTE COMPLETAMENTE ENSAMBLADA.

# ASSEMBLY INSTRUCTIONS INSTRUCTIONS DE MONTAGE INSTRUCCIONES DE MONTAJE

WOOD MEDIA CHEST SU

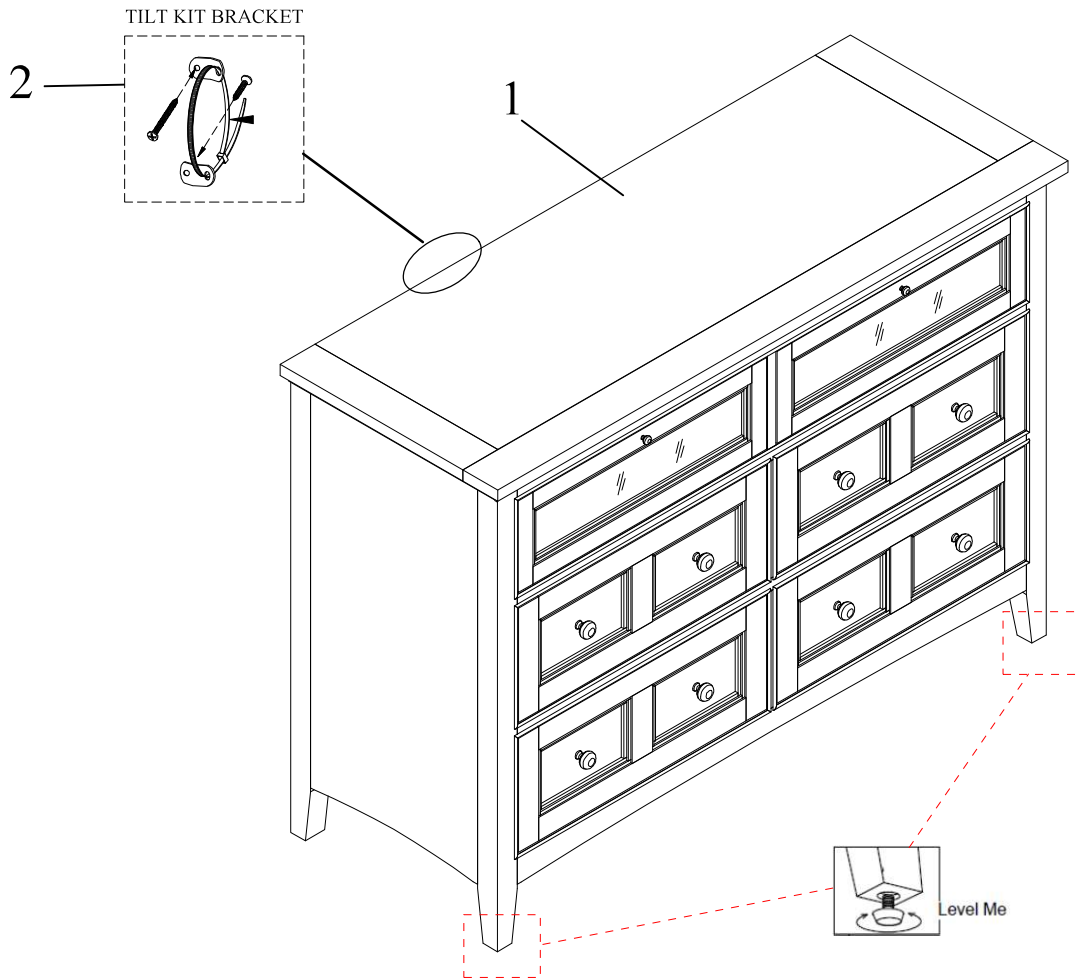

# ASSEMBLY INSTRUCTIONS INSTRUCTIONS DE MONTAGE INSTRUCCIONES DE MONTAJE

## LANDSCAPE MIRROR





**CAUTION:** PLEASE READ ALL INSTRUCTIONS BEFORE STARTING THE ASSEMBLY OF THIS PRODUCT. THESE PIECES ARE HEAVY. IN ORDER TO PREVENT PERSONAL INJURY AND ENSURE THAT THIS PRODUCT IS NOT DAMAGED DURING THE ASSEMBLY PROCESS, IT IS STRONGLY RECOMMENDED TO ENLIST THE ASSISTANCE OF ONE OR MORE PERSONS. IN CASE OF EXCESS STAIN, WIPE THE BOTTOM OF THE UNIT BEFORE PLACING ON ANY SURFACE.

**ATTENTION:** VEUILLEZ LIRE TOUTES LES INSTRUCTIONS AVANT DE COMMENCER L'ASSEMBLAGE DE CE PRODUIT. LES PIECES SONT LOURDES. POUR EVITER TOUTE BLESSURE ET POUR VOUS ASSURER QUE LE PRODUIT N'EST PAS ENDOMMAGE' PENDANT L'ASSEMBLAGE, NOUS VOUS RECOMMANDONS DE FAIRE APPEL A UNE OU PLUSIEURS AUTRES PERSONNES. EN CAS DE TACHE EXCESSIVE, ESSUYEZ LE FOND DE L'UNITE' AVANT LE PLACEMENT SUR N'IMPORTE QUELLE SURFACE.



**CUIDADO:** FAVOR DE LEER TODAS LAS INSTRUCCIONES ANTES DE ENSAMBLAR SU PRODUCTO, ESTAS PIEZAS SON PESADAS. PARA PREVENIR HERIDAS PERSONALES Y ASEGURAR QUE SU PRODUCTO NO SEA DAN ADO MIENTRAS ES ENSAMBLADO. SE RECOMIENDA LA ASISTENCIA DE UNA O MAUS PERSONAS.

**WARNING:** PROTECTIVE GLIDE IS PLACED UNDER EACH LEG OF THE FURNITURE TO RESIST SCRATCHES ON FLOOR SURFACE. SOME FLOOR SURFACES CAN BE EXTRA SENSITIVE TO SCRATCHES AND MARKINGS, IF YOU ARE NOT SURE CONSULT WITH YOUR DEALER. AVERTISSEMENT. LES PIEDS DES MEUBLES SONT MUNIS DE PATINS DESTINES A PROTEGER LE PLANCHER. CERTAINS REVETEMENTS DE SOL PEUVENT ETRE TRES FRAGILES. EN CAS DE DOUTE. CONSULTER LE MARCHAND.

### LIST OF PARTS AND HARDWARE/ LISTE DES PIÈCES ET DU MATÉRIEL/ LISTA DE PIEZAS Y HARDWARE

NO#/ NOMBRE/ NÚMERO	DESCRIPTION/ DESCRIPTION/ DESCRIPCIÓN	QUANTITY/ QUANTITÉ/ CANTIDAD
A	FLAT WASHER/ RONDELLE PLATE/ ARANDELA PLANA $\phi 5/16''*19*1.5\text{mm}$ 	8 PCS
B	LOCK WASHER/ RONDELLE DE BLOCAGE/ ARANDELA DE BLOQUEO $\phi 5/16''*13*1\text{mm}$ 	8 PCS
C	BOLT/ BOULON/ TORNILLO $\phi 5/16''*1-1/2''\text{L}$ 	8 PCS
D	ALLEN WRENCH/ CLÉ ALLEN/ LLAVE INGLESA ALLEN 4mm 	1 PC

### LIST OF PARTS AND HARDWARE/ LISTE DES PIÈCES ET DU MATÉRIEL/ LISTA DE PIEZAS Y HARDWARE

NO#/ NOMBRE/ NÚMERO	DESCRIPTION/ DESCRIPTION/ DESCRIPCIÓN	QUANTITY/ QUANTITÉ/ CANTIDAD
1	TOP DRESSER/ DRESSER DESSUS/ APARADOR SUPERIOR 	1 PC
2	MIRROR/ MIROIR/ ESPEJO 	1 PC
3	SUPPORT/ SUPPORT/SOPORTE 	2 PCS

**NOTE:**  
ASSEMBLE UNIT ON A SOFT SURFACE.  
ASSEMBLEZ L'UNITÉ SUR UNE SURFACE MOLLE.  
ENSAMBLE LA UNIDAD EN UNA SUPERFICIE PLANA Y SUAVE.

DO NOT TIGHTEN BOLTS UNTIL THE UNIT IS COMPLETELY ASSEMBLED.  
NE SERREZ PAS LES BOULONS JUSQU'À CE QUE L'UNITÉ SOIT COMPLÈTEMENT ASSEMBLÉE.  
NO APRIETE LOS TORNILLOS HASTA QUE LA UNIDAD ESTE COMPLETAMENTE ENSAMBLADA.

ASSEMBLY INSTRUCTIONS  
INSTRUCTIONS DE MONTAGE  
INSTRUCCIONES DE MONTAJE

LANDSCAPE MIRROR

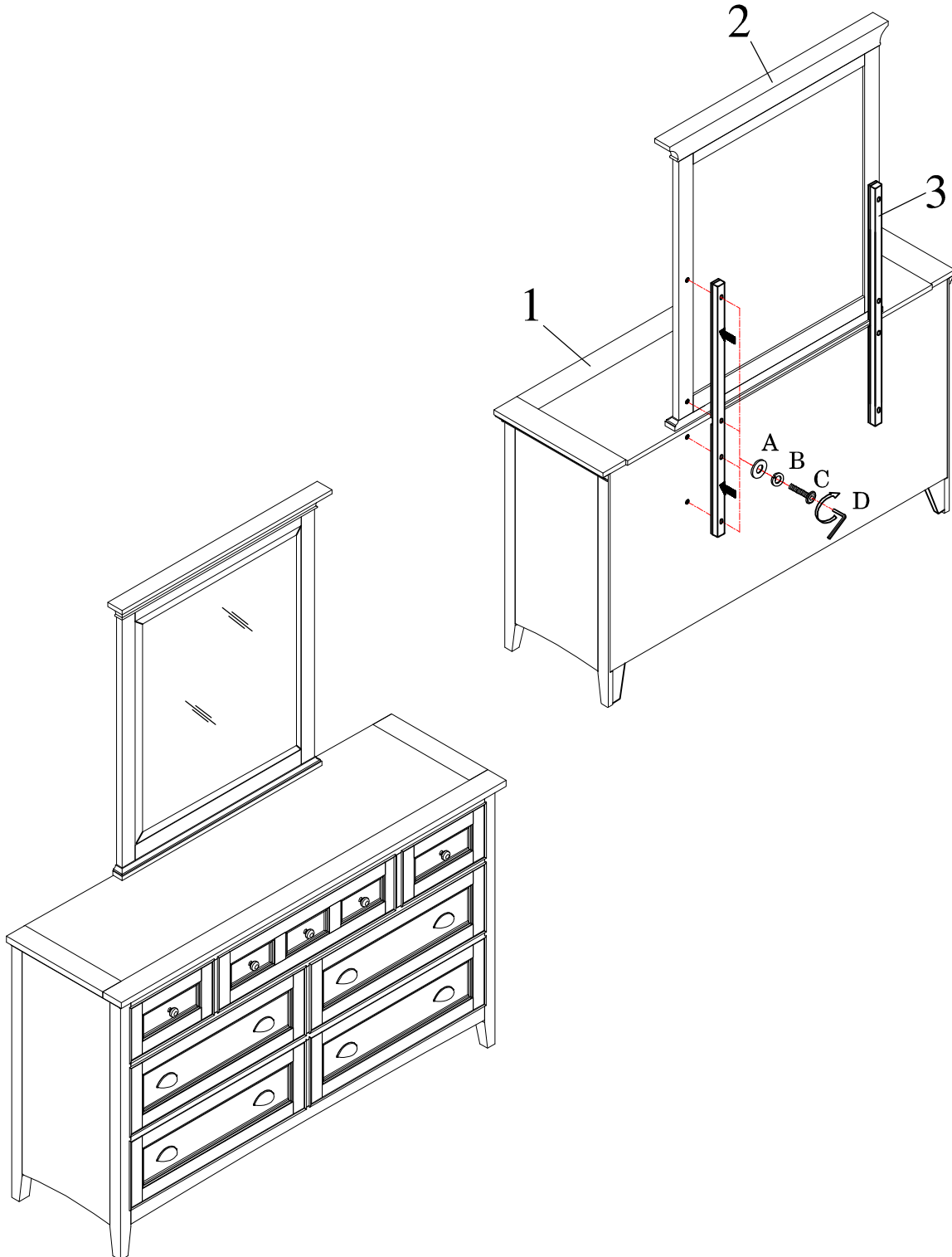

# ASSEMBLY INSTRUCTIONS INSTRUCTIONS DE MONTAGE INSTRUCCIONES DE MONTAJE

## QUEEN LIGHTED PANEL BED W/ STORAGE FOOTBOARD

**CAUTION:** PLEASE READ ALL INSTRUCTIONS BEFORE STARTING THE ASSEMBLY OF THIS PRODUCT. THESE PIECES ARE HEAVY. IN ORDER TO PREVENT PERSONAL INJURY AND ENSURE THAT THIS PRODUCT IS NOT DAMAGED DURING THE ASSEMBLY PROCESS, IT IS STRONGLY RECOMMENDED TO ENLIST THE ASSISTANCE OF ONE OR MORE PERSONS. IN CASE OF EXCESS STAIN, WIPE THE BOTTOM OF THE UNIT BEFORE PLACING ON ANY SURFACE.

**ATTENTION:** VEUILLEZ LIRE TOUTES LES INSTRUCTIONS AVANT DE COMMENCER L'ASSEMBLAGE DE CE PRODUIT. LES PIECES SONT LOURDES. POUR EVITER TOUTE BLESSURE ET POUR VOUS ASSURER QUE LE PRODUIT N'EST PAS ENDOMMAGE' PENDANT L'ASSEMBLAGE, NOUS VOUS RECOMMANDONS DE FAIRE APPEL A UNE OU PLUSIEURS AUTRES PERSONNES. EN CAS DE TACHE EXCESSIVE, ESSUYEZ LE FOND DE L'UNITE' AVANT LE PLACEMENT SUR N'IMPORTE QUELLE SURFACE.

**CUIDADO:** FAVOR DE LEER TODAS LAS INSTRUCCIONES ANTES DE ENSAMBLAR SU PRODUCTO, ESTAS. PIEZAS SON PESADAS. PARA PREVENIR HERIDAS PERSONALES Y ASEGURAR QUE SU PRODUCTO NO SEA DAN ADO MIENTRAS ES ENSAMBLADO. SE RECOMIENDA LA ASISTENCIA DE UNA O MAUS PERSONAS.

**WARNING:** PROTECTIVE GLIDE IS PLACED UNDER EACH LEG OF THE FURNITURE TO RESIST SCRATCHES ON FLOOR SURFACE. SOME FLOOR SURFACES CAN BE EXTRA SENSITIVE TO SCRATCHES AND MARKINGS, IF YOU ARE NOT SURE CONSULT WITH YOUR DEALER. AVERTISSEMENT. LES PIEDS DES MEUBLES SONT MUNIS DE PATINS DESTINES A PROTEGER LE PLANCHER. CERTAINS REVETEMENTS DE SOL PEUVENT ETRE TRES FRAGILES. EN CAS DE DOUTE. CONSULTER LE MARCHAND.

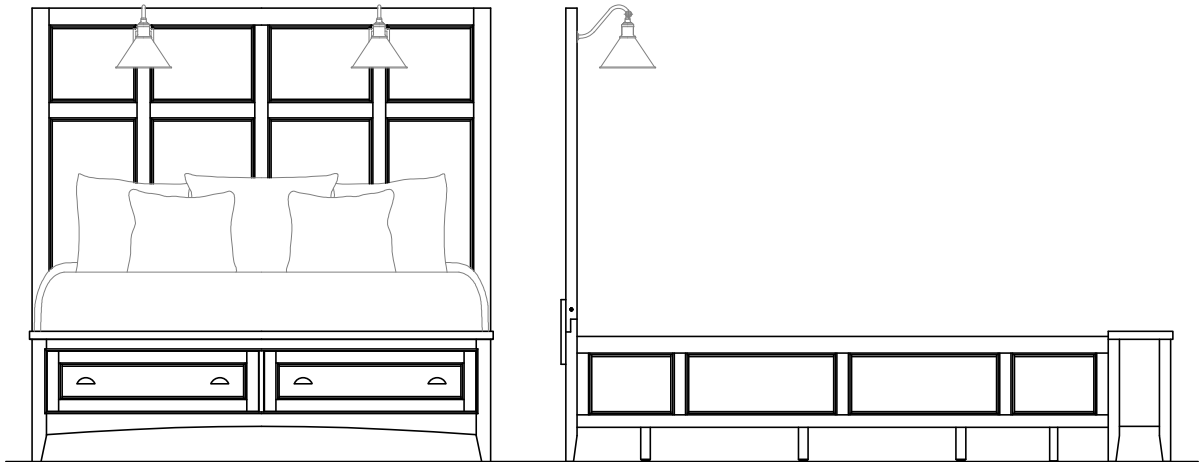











NOTE:  
ASSEMBLE UNIT ON A SOFT SURFACE.  
ASSEMBLEZ L'UNITE' SUR UNE SURFACE MOLLE.  
ENSAMBLE LA UNIDAD EN UNA SUPERFICIE PLANA Y SUAVE.

DO NOT TIGHTEN BOLTS UNTIL **ALL PARTS AND HARDWARE OF THE UNIT ARE ASSEMBLED.**  
NE SERREZ PAS LES BOULONS JUSQU'À CE QUE L'UNITE' SOIT COMPLÈTEMENT ASSEMBLÉE.  
NO APRIETE LOS TORNILLOS HASTA QUE LA UNIDAD ESTE COMPLETAMENTE ENSAMBLADA.













# ASSEMBLY INSTRUCTIONS INSTRUCTIONS DE MONTAGE INSTRUCCIONES DE MONTAJE

## QUEEN LIGHTED PANEL BED W/ STORAGE FOOTBOARD

### LIST OF PARTS AND HARDWARE/ LISTE DES PIÈCES ET DU MATÉRIEL/ LISTA DE PIEZAS Y HARDWARE

NO#/ NOMBRE/ NÚMERO	DESCRIPTION/ DESCRIPTION/ DESCRIPCIÓN		QUANTITY/ QUANTITÉ/ CANTIDAD
A	BOLT/ BOULON/ TORNILLO $\frac{5}{16}$ " DIAMETER x $4\frac{1}{2}$ " LENGTH		8 PCS
B	CURVED WASHER/RONDELLE COURBE/ ARANDELA CURVA $\frac{5}{16}$ " DIAMETER		8 PCS
C	NUT/ÉCROU/NUEZ $\frac{5}{16}$ " DIAMETER		8 PCS
D	WRENCH/ CLÉ/LLAVE INGLESA 1/2"		1 PC
E	FLAT WASHER/ RONDELLE PLATE/ ARANDELA PLANA $\frac{5}{16}$ " DIAMETER x $\frac{3}{4}$ " x $\frac{1}{16}$ "		12 PCS
F	LOCK WASHER/ RONDELLE DE BLOQUE/ ARANDELA DE BLOQUEO $\frac{5}{16}$ " DIAMETER x $\frac{1}{2}$ " x $\frac{1}{16}$ "		12 PCS
G	BOLT/ BOULON/ TORNILLO $\frac{5}{16}$ " DIAMETER x 2" LENGTH		10 PCS
H	ALLEN KEY/ CLÉ ALLEN/LLAVE INGLESA ALLEN 3/16"		1 PC
I	SCREW/VIS/TORNILLO #4 x 1" LENGTH		28 PCS
J	BOLT/ BOULON/ TORNILLO $\frac{5}{16}$ " DIAMETER x $1\frac{3}{16}$ " LENGTH		2 PCS

### LIST OF PARTS AND HARDWARE/ LISTE DES PIÈCES ET DU MATÉRIEL/ LISTA DE PIEZAS Y HARDWARE

NO#/ NOMBRE/ NÚMERO	DESCRIPTION/ DESCRIPTION/ DESCRIPCIÓN		QUANTITY/ QUANTITÉ/ CANTIDAD
1	HEADBOARD PANEL/PANNEAU DE TÊTE DE LIT/ PANEL DE CABECERO		1 PC
2	BOTTOM STRETCHER/ÉTIREUSE INFÉRIEURE/ CAMILLA INFERIOR		1 PC
3	LEFT HEADBOARD LEG/JAMBE DE TÊTE DE LIT GAUCHE/ PIERNA IZQUIERDA DEL CABECERO		1 PC
4	RIGHT HEADBOARD LEG/PIED DE TÊTE DE LIT DROIT/ PATAS DEL CABECERO DERECHO		1 PC
5	WOODEN MENDING PLATE/PLAQUE DE RÉPARATION EN BOIS/PLACA DE MADERA PARA MENDER		2 PCS
6	FOOTBOARD/ PIED DE LIT/ ESTRIBO		1 PC
7	SIDE RAIL/RAIL LATÉRAL/CARRIL LATERAL		2 PCS
8	SLAT ROLL (INCLUDED 13 PCS)/ROULEAU DE FENTE/ ROLLO DE RANURA		1 SET
9	BOTTOM SLAT/LAME INFÉRIEURE/LLANTA INFERIOR		2 PCS
10	SLAT SUPPORT LEG/JAMBE DE SUPPORT À LATTES/ PATAS DE SOPORTE DE LAMAS		6 PCS
11	BULB HOLDER/ PORTE-AMPOULE/ PORTALÁMPARAS		2 PCS
12	LAMP SHADE/ FORME DE LA LAMPE/ PANTALLA DE LÁMPARA		2 PCS
13	(OUTPUT: 12V-MAX:3W) LED LIGHT/LUMIÈRE LED/LUZ LED		2 PCS

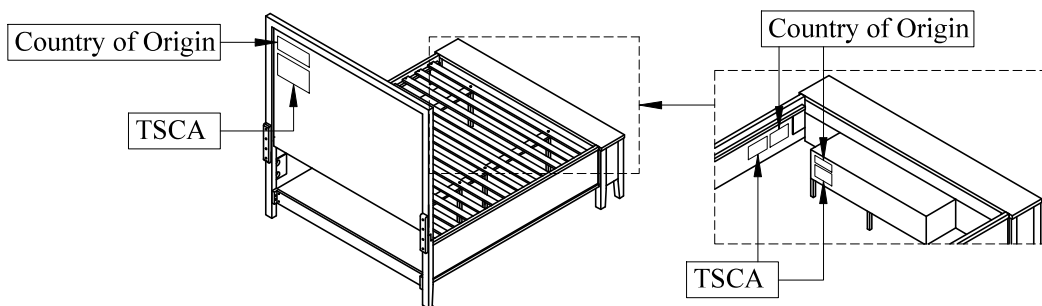

# ASSEMBLY INSTRUCTIONS INSTRUCTIONS DE MONTAGE INSTRUCCIONES DE MONTAJE

QUEEN LIGHTED PANEL BED W/ STORAGE FOOTBOARD

**Note:** Side rail      **Mark**      HB or FB

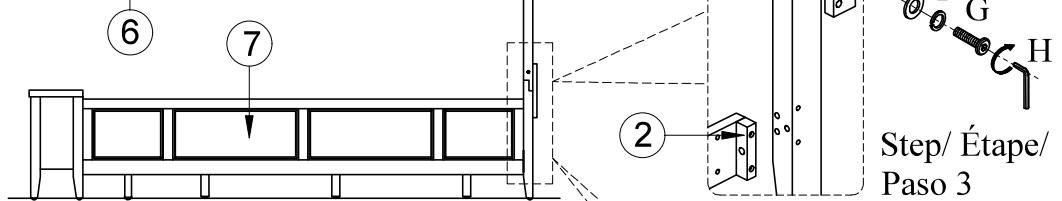
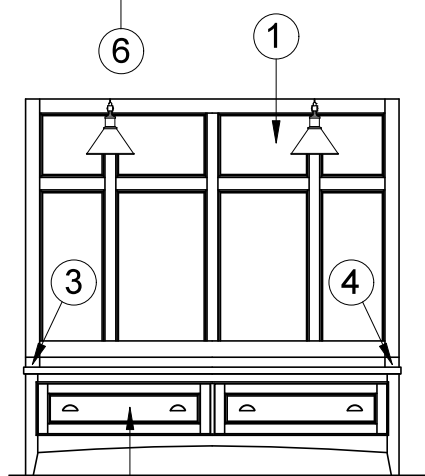
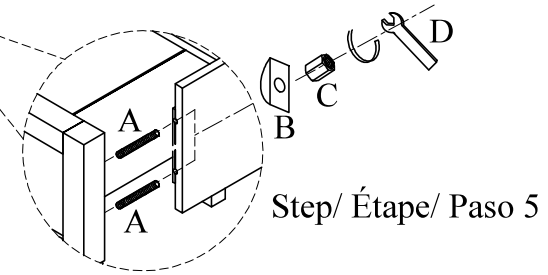
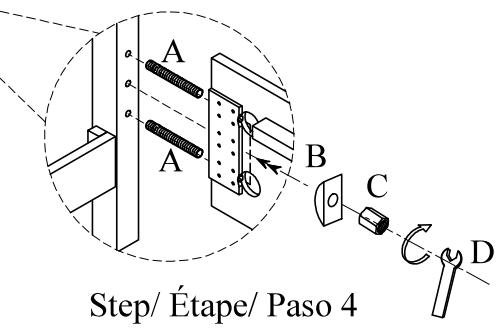
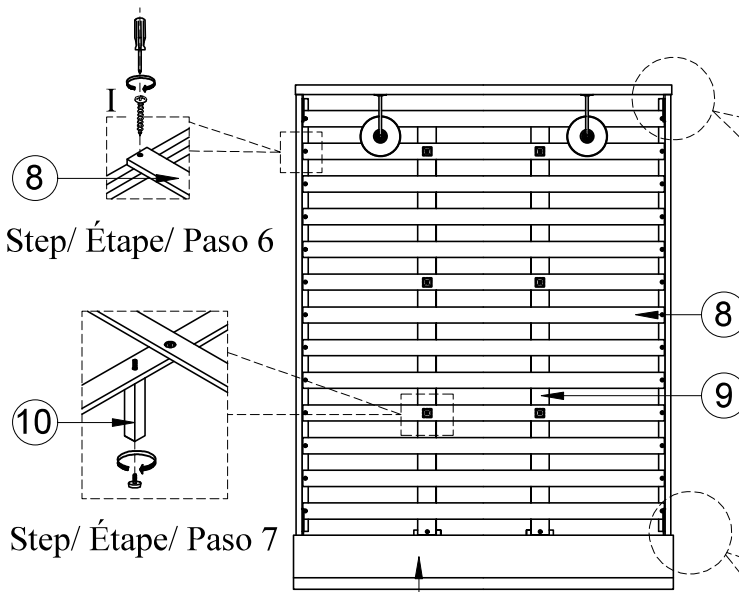

**WARNING:**  
ONLY USE THE HAND  
TOOLS PROVIDED

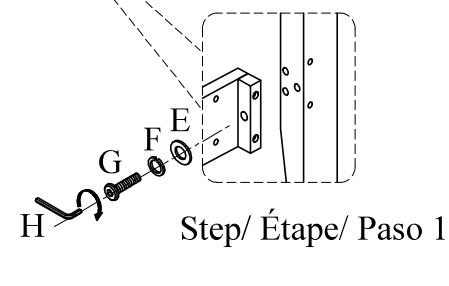
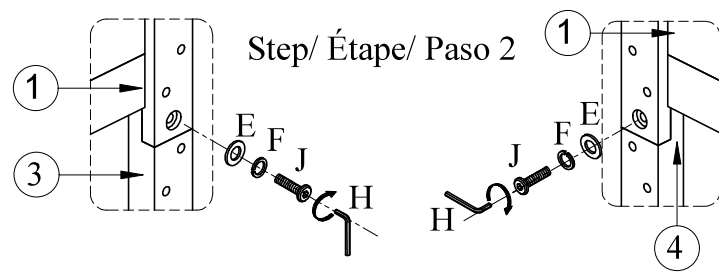

ASSEMBLY INSTRUCTIONS  
INSTRUCTIONS DE MONTAGE  
INSTRUCCIONES DE MONTAJE

QUEEN LIGHTED PANEL BED W/ STORAGE FOOTBOARD

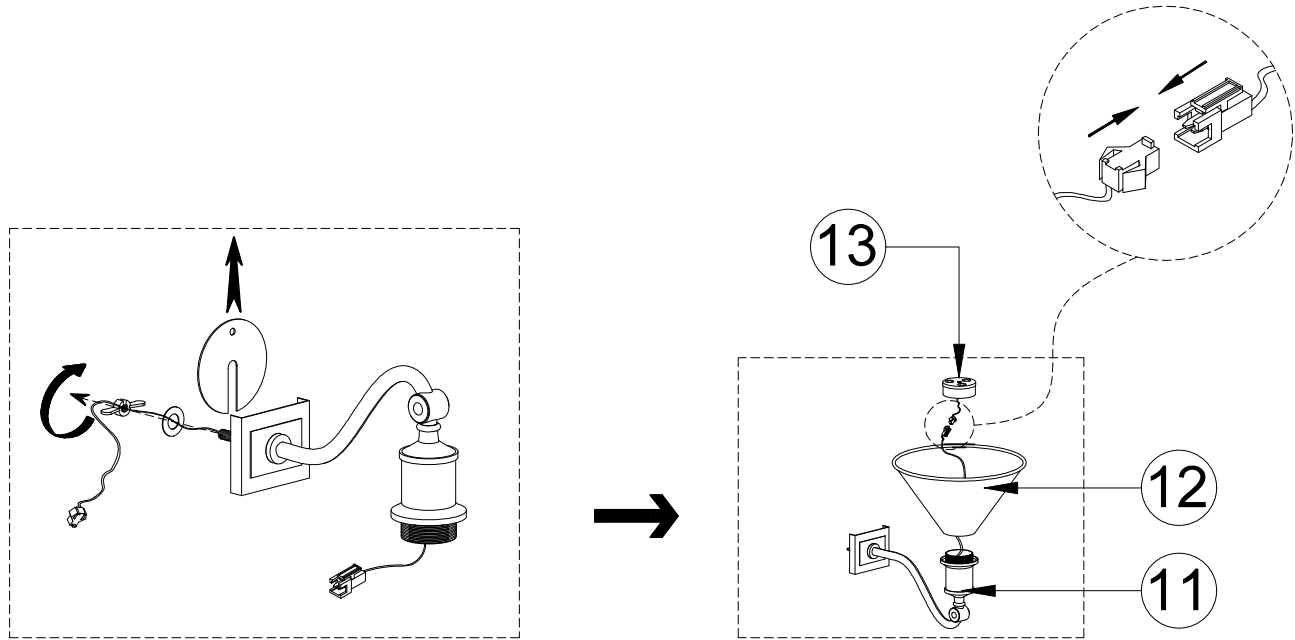

Step/ Étape/ Paso 8

Step/ Étape/ Paso 9

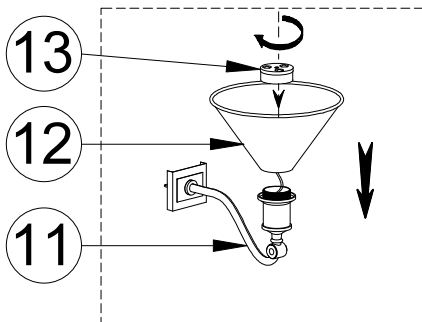

Step/ Étape/ Paso 10

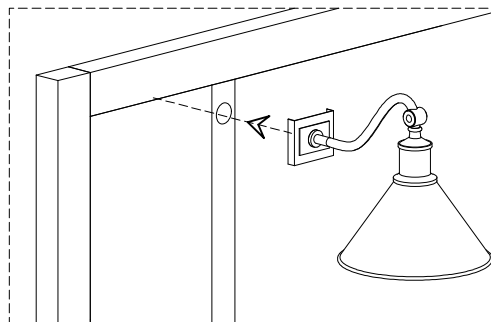

Step/ Étape/ Paso 11

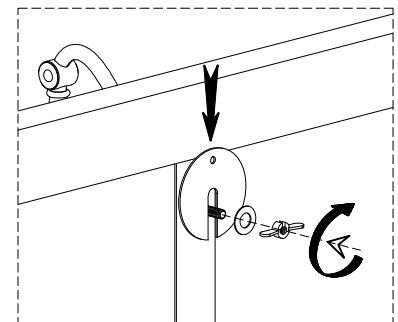

Step/ Étape/ Paso 12

**Note: Tighten the nut by hand only, until the fixture is secure, take care not to overtighten.**

# ASSEMBLY INSTRUCTIONS INSTRUCTIONS DE MONTAGE INSTRUCCIONES DE MONTAJE

QUEEN LIGHTED PANEL BED W/ STORAGE FOOTBOARD

## WIRING DIAGRAM

### Step/ Étape/ Paso 13

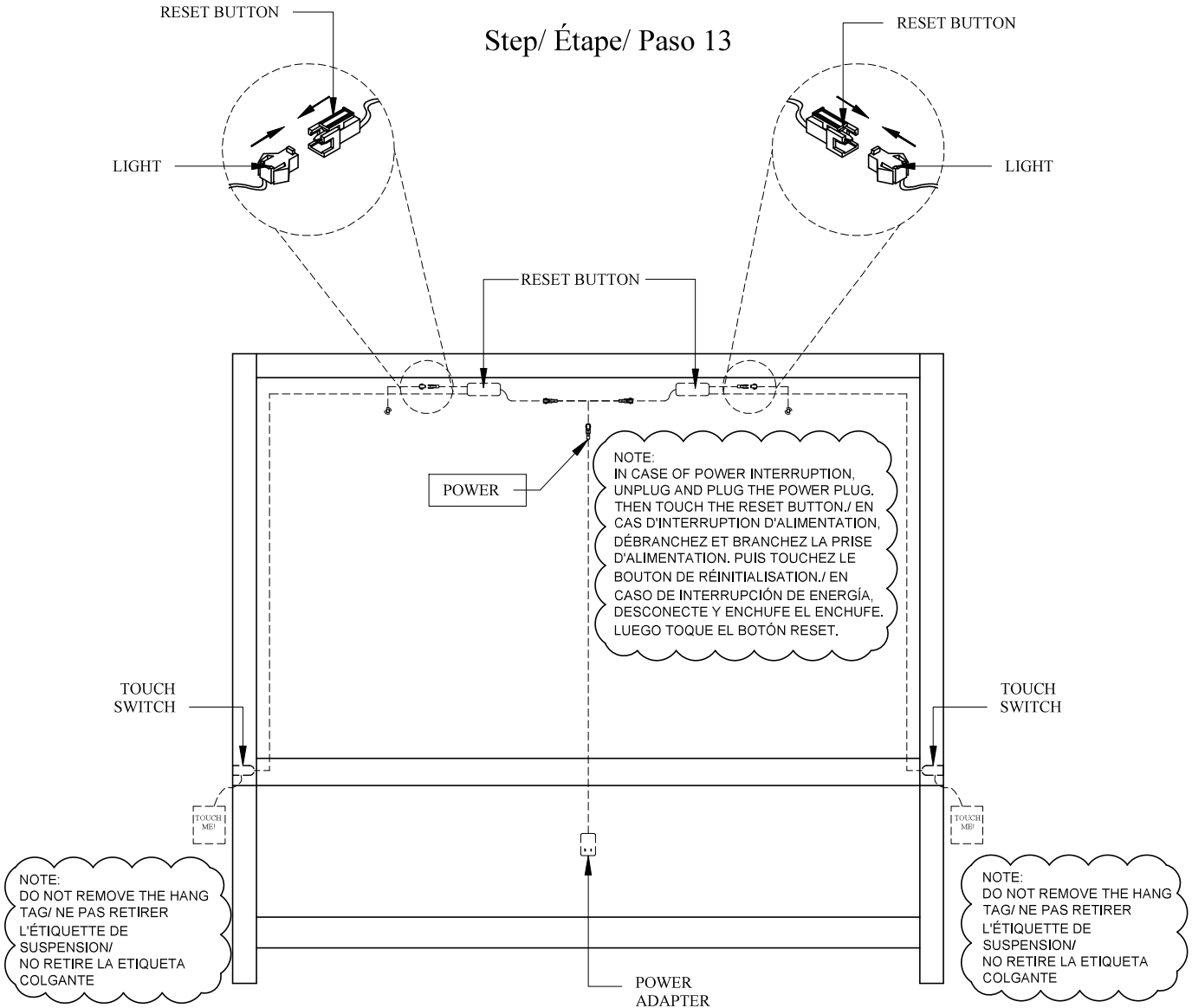

# ASSEMBLY INSTRUCTIONS INSTRUCTIONS DE MONTAGE INSTRUCCIONES DE MONTAJE

## KING LIGHTED PANEL BED W/ STORAGE FOOTBOARD

**CAUTION:** PLEASE READ ALL INSTRUCTIONS BEFORE STARTING THE ASSEMBLY OF THIS PRODUCT. THESE PIECES ARE HEAVY. IN ORDER TO PREVENT PERSONAL INJURY AND ENSURE THAT THIS PRODUCT IS NOT DAMAGED DURING THE ASSEMBLY PROCESS, IT IS STRONGLY RECOMMENDED TO ENLIST THE ASSISTANCE OF ONE OR MORE PERSONS. IN CASE OF EXCESS STAIN, WIPE THE BOTTOM OF THE UNIT BEFORE PLACING ON ANY SURFACE.

**ATTENTION:** VEUILLEZ LIRE TOUTES LES INSTRUCTIONS AVANT DE COMMENCER L'ASSEMBLAGE DE CE PRODUIT. LES PIECES SONT LOURDES. POUR EVITER TOUTE BLESSURE ET POUR VOUS ASSURER QUE LE PRODUIT N'EST PAS ENDOMMAGE' PENDANT L'ASSEMBLAGE, NOUS VOUS RECOMMANDONS DE FAIRE APPEL A UNE OU PLUSIEURS AUTRES PERSONNES. EN CAS DE TACHE EXCESSIVE, ESSUYEZ LE FOND DE L'UNITE' AVANT LE PLACEMENT SUR N'IMPORTE QUELLE SURFACE.

**CUIDADO:** FAVOR DE LEER TODAS LAS INSTRUCCIONES ANTES DE ENSAMBLAR SU PRODUCTO, ESTAS. PIEZAS SON PESADAS. PARA PREVENIR HERIDAS PERSONALES Y ASEGURAR QUE SU PRODUCTO NO SEA DAN ADO MIENTRAS ES ENSAMBLADO. SE RECOMIENDA LA ASISTENCIA DE UNA O MAUS PERSONAS.

**WARNING:** PROTECTIVE GLIDE IS PLACED UNDER EACH LEG OF THE FURNITURE TO RESIST SCRATCHES ON FLOOR SURFACE. SOME FLOOR SURFACES CAN BE EXTRA SENSITIVE TO SCRATCHES AND MARKINGS, IF YOU ARE NOT SURE CONSULT WITH YOUR DEALER. AVERTISSEMENT. LES PIEDS DES MEUBLES SONT MUNIS DE PATINS DESTINES A PROTEGER LE PLANCHER. CERTAINS REVETEMENTS DE SOL PEUVENT ETRE TRES FRAGILES. EN CAS DE DOUTE. CONSULTER LE MARCHAND.

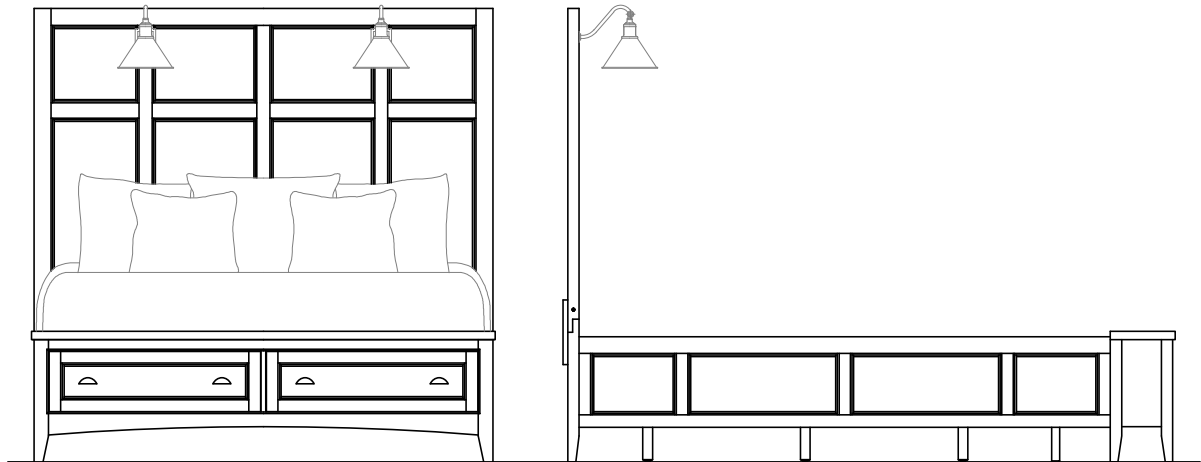











NOTE:  
ASSEMBLE UNIT ON A SOFT SURFACE.  
ASSEMBLEZ L'UNITE' SUR UNE SURFACE MOLLE.  
ENSAMBLE LA UNIDAD EN UNA SUPERFICIE PLANA Y SUAVE.

DO NOT TIGHTEN BOLTS UNTIL **ALL PARTS AND HARDWARE OF THE UNIT ARE ASSEMBLED.**  
NE SERREZ PAS LES BOULONS JUSQU'À CE QUE L'UNITE' SOIT COMPLÈTEMENT ASSEMBLÉE.  
NO APRIETE LOS TORNILLOS HASTA QUE LA UNIDAD ESTE COMPLETAMENTE ENSAMBLADA.











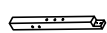

# ASSEMBLY INSTRUCTIONS INSTRUCTIONS DE MONTAGE INSTRUCCIONES DE MONTAJE

## KING LIGHTED PANEL BED W/ STORAGE FOOTBOARD

### LIST OF PARTS AND HARDWARE/ LISTE DES PIÈCES ET DU MATÉRIEL/ LISTA DE PIEZAS Y HARDWARE

NO#/ NOMBRE/ NÚMERO	DESCRIPTION/ DESCRIPTION/ DESCRIPCIÓN		QUANTITY/ QUANTITÉ/ CANTIDAD
A	BOLT/ BOULON/ TORNILLO <span style="float: right;"><math>\frac{5}{16}</math>" DIAMETER x 4 <math>\frac{1}{2}</math>" LENGTH</span>		8 PCS
B	CURVED WASHER/RONDELLE COURBE/ ARANDELA CURVA <span style="float: right;"><math>\frac{5}{16}</math>" DIAMETER</span>		8 PCS
C	NUT/ÉCROU/NUEZ <span style="float: right;"><math>\frac{5}{16}</math>" DIAMETER</span>		8 PCS
D	WRENCH/ CLÉ/LLAVE INGLESA <span style="float: right;">1/2"</span>		1 PC
E	FLAT WASHER/ RONDELLE PLATE/ ARANDELA PLANA <span style="float: right;"><math>\frac{5}{16}</math>" DIAMETER x <math>\frac{3}{4}</math>" x <math>\frac{1}{16}</math>"</span>		12 PCS
F	LOCK WASHER/ RONDELLE DE BLOCAGE/ ARANDELA DE BLOQUEO <span style="float: right;"><math>\frac{5}{16}</math>" DIAMETER x <math>\frac{1}{2}</math>" x <math>\frac{1}{16}</math>"</span>		12 PCS
G	BOLT/ BOULON/ TORNILLO <span style="float: right;"><math>\frac{3}{16}</math>" DIAMETER x 2" LENGTH</span>		10 PCS
H	ALLEN KEY/ CLÉ ALLEN/LLAVE INGLESA ALLEN <span style="float: right;">3/16"</span>		1 PC
I	SCREW/VIS/TORNILLO <span style="float: right;">#4 x 1" LENGTH</span>		29 PCS
J	BOLT/ BOULON/ TORNILLO <span style="float: right;"><math>\frac{5}{16}</math>" DIAMETER x 1 <math>\frac{3}{16}</math>" LENGTH</span>		2 PCS

### LIST OF PARTS AND HARDWARE/ LISTE DES PIÈCES ET DU MATÉRIEL/ LISTA DE PIEZAS Y HARDWARE

NO#/ NOMBRE/ NÚMERO	DESCRIPTION/ DESCRIPTION/ DESCRIPCIÓN		QUANTITY/ QUANTITÉ/ CANTIDAD
1	HEADBOARD PANEL/PANNEAU DE TÊTE DE LIT/ PANEL DE CABECERO		1 PC
2	BOTTOM STRETCHER/ÉTIREUSE INFÉRIEURE/ CAMILLA INFERIOR		1 PC
3	LEFT HEADBOARD LEG/JAMBE DE TÊTE DE LIT GAUCHE/ PIERNA IZQUIERDA DEL CABECERO		1 PC
4	RIGHT HEADBOARD LEG/PIED DE TÊTE DE LIT DROIT/ PATAS DEL CABECERO DERECHO		1 PC
5	WOODEN MENDING PLATE/PLAQUE DE RÉPARATION EN BOIS/PLACA DE MADERA PARA MENDER		2 PCS
6	FOOTBOARD/ PIED DE LIT/ ESTRIBO		1 PC
7	SIDE RAIL/RAIL LATÉRAL/CARRIL LATERAL		2 PCS
8	SLAT ROLL (INCLUDED 13 PCS)/ROULEAU DE FENTE/ ROLLO DE RANURA		1 SET
9	BOTTOM SLAT/LAME INFÉRIEURE/LLANTA INFERIOR		3 PCS
10	SLAT SUPPORT LEG/JAMBE DE SUPPORT À LATTES/ PATAS DE SOPORTE DE LAMAS		9 PCS
11	BULB HOLDER/ PORTE-AMPOULE/ PORTALÁMPARAS		2 PCS
12	LAMP SHADE/ FORME DE LA LAMPE/ PANTALLA DE LÁMPARA		2 PCS
13	(OUTPUT: 12V-MAX:3W) LED LIGHT/LUMIÈRE LED/LUZ LED		2 PCS

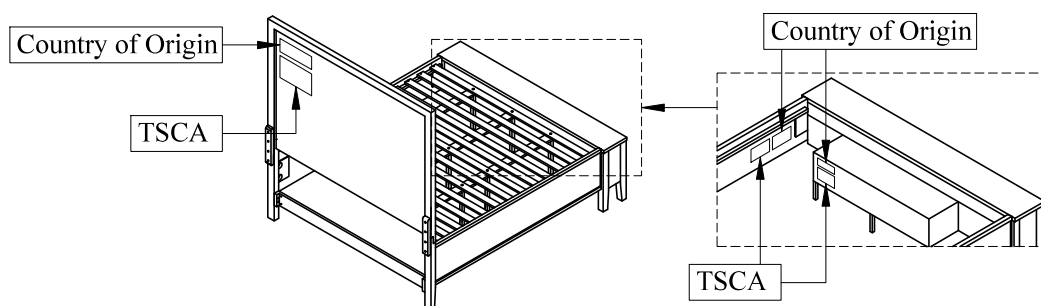

# ASSEMBLY INSTRUCTIONS INSTRUCTIONS DE MONTAGE INSTRUCCIONES DE MONTAJE

KING LIGHTED PANEL BED W/ STORAGE FOOTBOARD

Note: Side rail ←  → HB or FB

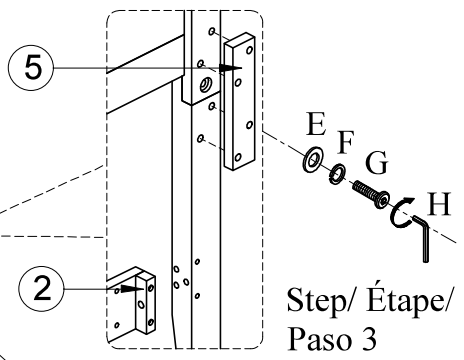
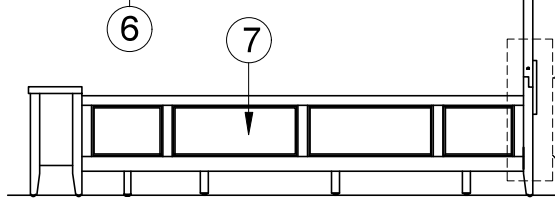
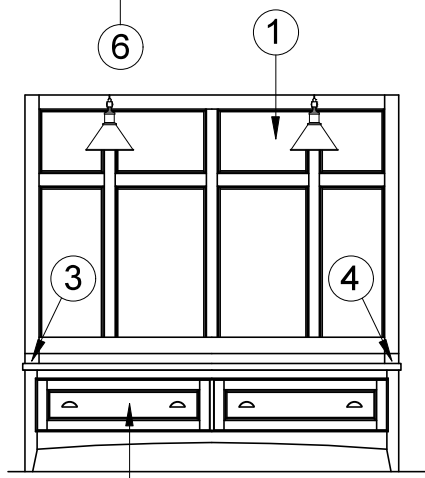
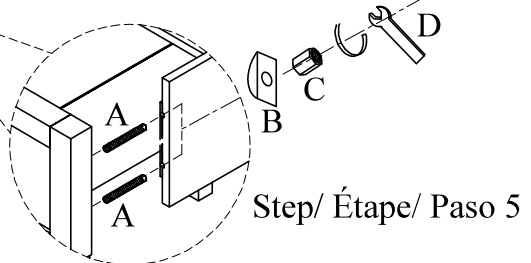
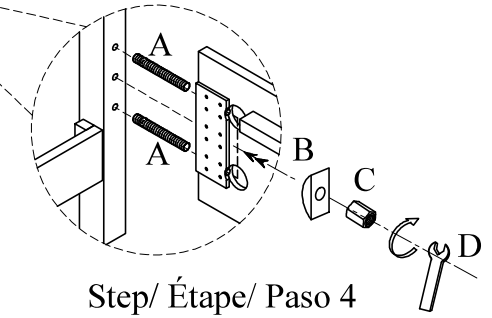
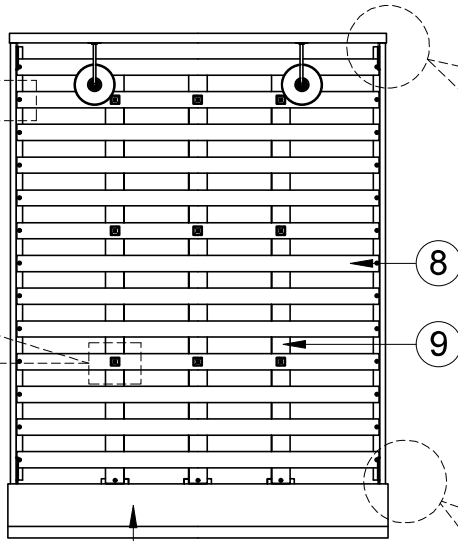
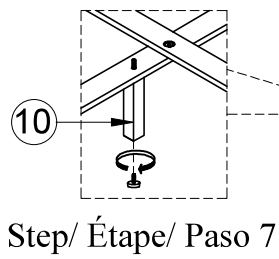
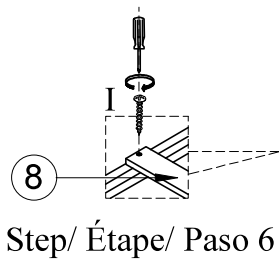

WARNING:  
ONLY USE THE HAND  
TOOLS PROVIDED

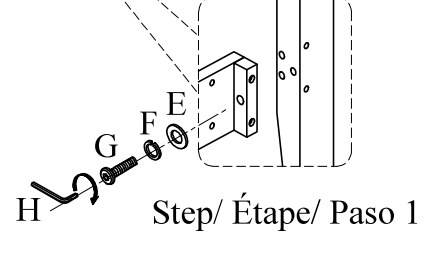
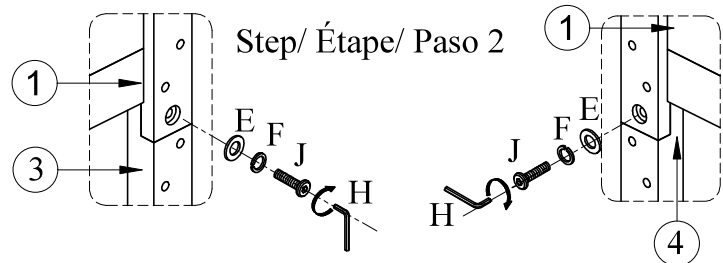

ASSEMBLY INSTRUCTIONS  
INSTRUCTIONS DE MONTAGE  
INSTRUCCIONES DE MONTAJE

KING LIGHTED PANEL BED W/ STORAGE FOOTBOARD

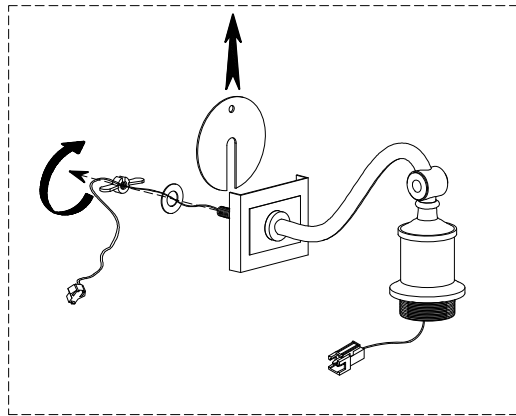

Step/ Étape/ Paso 8

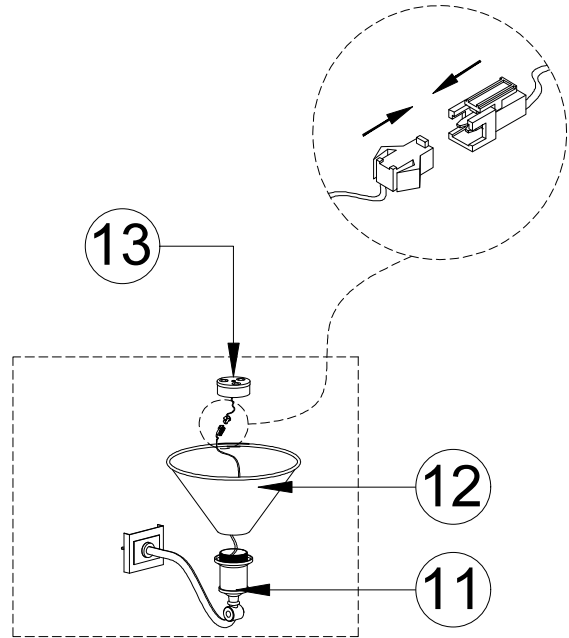

Step/ Étape/ Paso 9

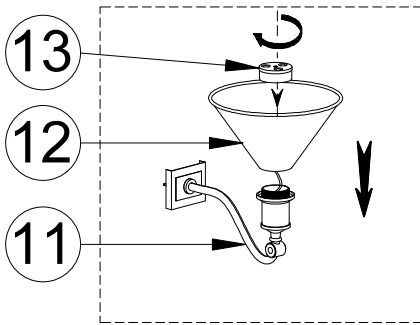

Step/ Étape/ Paso 10

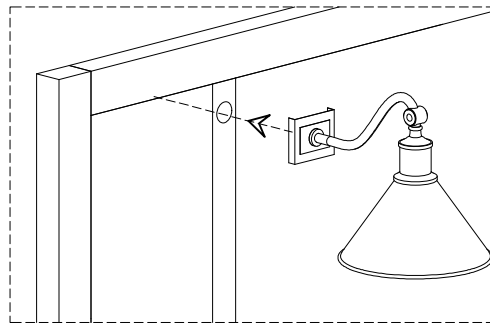

Step/ Étape/ Paso 11

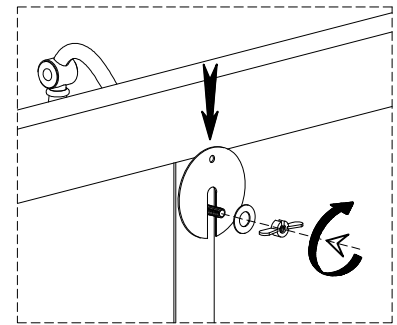

Step/ Étape/ Paso 12

**Note: Tighten the nut by hand only, until the fixture is secure, take care not to overtighten.**

# ASSEMBLY INSTRUCTIONS INSTRUCTIONS DE MONTAGE INSTRUCCIONES DE MONTAJE

KING LIGHTED PANEL BED W/ STORAGE FOOTBOARD

## WIRING DIAGRAM

### Step/ Étape/ Paso 13

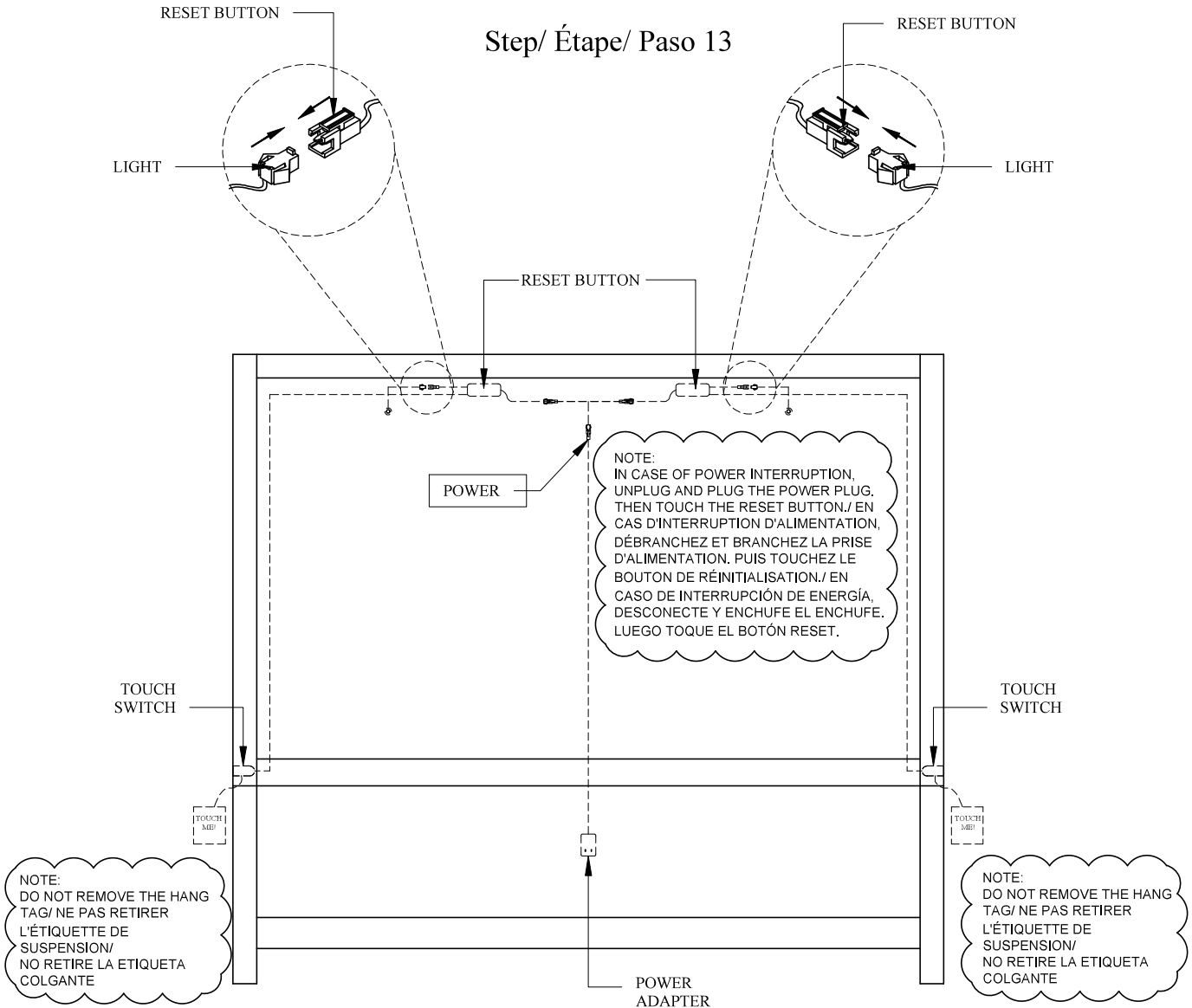

# ASSEMBLY INSTRUCTIONS INSTRUCTIONS DE MONTAGE INSTRUCCIONES DE MONTAJE

CAL. KING LIGHTED PANEL BED W/ STORAGE FOOTBOARD

**CAUTION:** PLEASE READ ALL INSTRUCTIONS BEFORE STARTING THE ASSEMBLY OF THIS PRODUCT. THESE PIECES ARE HEAVY. IN ORDER TO PREVENT PERSONAL INJURY AND ENSURE THAT THIS PRODUCT IS NOT DAMAGED DURING THE ASSEMBLY PROCESS, IT IS STRONGLY RECOMMENDED TO ENLIST THE ASSISTANCE OF ONE OR MORE PERSONS. IN CASE OF EXCESS STAIN, WIPE THE BOTTOM OF THE UNIT BEFORE PLACING ON ANY SURFACE.

**ATTENTION:** VEUILLEZ LIRE TOUTES LES INSTRUCTIONS AVANT DE COMMENCER L'ASSEMBLAGE DE CE PRODUIT. LES PIECES SONT LOURDES. POUR EVITER TOUTE BLESSURE ET POUR VOUS ASSURER QUE LE PRODUIT N'EST PAS ENDOMMAGE' PENDANT L'ASSEMBLAGE, NOUS VOUS RECOMMANDONS DE FAIRE APPEL A UNE OU PLUSIEURS AUTRES PERSONNES. EN CAS DE TACHE EXCESSIVE, ESSUYEZ LE FOND DE L'UNITE' AVANT LE PLACEMENT SUR N'IMPORTE QUELLE SURFACE.

**CUIDADO:** FAVOR DE LEER TODAS LAS INSTRUCCIONES ANTES DE ENSAMBLAR SU PRODUCTO, ESTAS. PIEZAS SON PESADAS. PARA PREVENIR HERIDAS PERSONALES Y ASEGURAR QUE SU PRODUCTO NO SEA DAN ADO MIENTRAS ES ENSAMBLADO. SE RECOMIENDA LA ASISTENCIA DE UNA O MAUS PERSONAS.

**WARNING:** PROTECTIVE GLIDE IS PLACED UNDER EACH LEG OF THE FURNITURE TO RESIST SCRATCHES ON FLOOR SURFACE. SOME FLOOR SURFACES CAN BE EXTRA SENSITIVE TO SCRATCHES AND MARKINGS, IF YOU ARE NOT SURE CONSULT WITH YOUR DEALER.  
AVERTISSEMENT. LES PIEDS DES MEUBLES SONT MUNIS DE PATINS DESTINES A PROTEGER LE PLANCHER. CERTAINS REVETEMENTS DE SOL PEUVENT ETRE TRES FRAGILES. EN CAS DE DOUTE. CONSULTER LE MARCHAND.

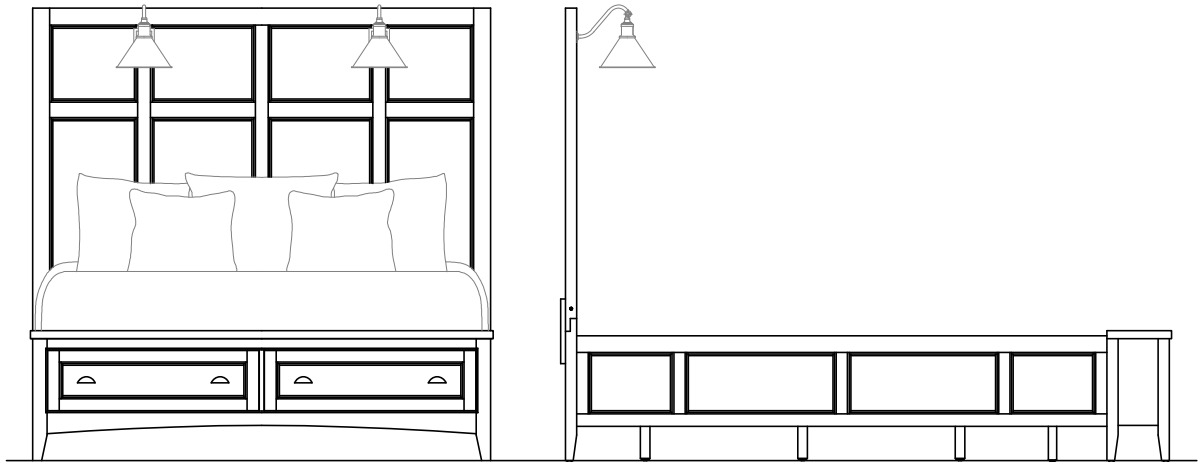











NOTE:  
ASSEMBLE UNIT ON A SOFT SURFACE.  
ASSEMBLEZ L'UNITÉ SUR UNE SURFACE MOLLE.  
ENSAMBLE LA UNIDAD EN UNA SUPERFICIE PLANA Y SUAVE.

DO NOT TIGHTEN BOLTS UNTIL **ALL PARTS AND HARDWARE OF THE UNIT ARE ASSEMBLED.**  
NE SERREZ PAS LES BOULONS JUSQU'À CE QUE L'UNITÉ SOIT COMPLÈTEMENT ASSEMBLÉE.  
NO APRIETE LOS TORNILLOS HASTA QUE LA UNIDAD ESTE COMPLETAMENTE ENSAMBLADA.









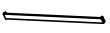
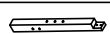
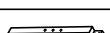

# ASSEMBLY INSTRUCTIONS INSTRUCTIONS DE MONTAGE INSTRUCCIONES DE MONTAJE

## CAL. KING LIGHTED PANEL BED W/ STORAGE FOOTBOARD

### LIST OF PARTS AND HARDWARE/ LISTE DES PIÈCES ET DU MATÉRIEL/ LISTA DE PIEZAS Y HARDWARE

NO#/ NOMBRE/ NÚMERO	DESCRIPTION/ DESCRIPTION/ DESCRIPCIÓN		QUANTITY/ QUANTITÉ/ CANTIDAD
A	BOLT/ BOULON/ TORNILLO $\frac{5}{16}$ " DIAMETER x $4\frac{1}{2}$ " LENGTH		8 PCS
B	CURVED WASHER/RONDELLE COURBE/ ARANDELA CURVA $\frac{5}{16}$ " DIAMETER		8 PCS
C	NUT/ÉCROU/NUEZ $\frac{5}{16}$ " DIAMETER		8 PCS
D	WRENCH/ CLÉ/LLAVE INGLESA 1/2"		1 PC
E	FLAT WASHER/ RONDELLE PLATE/ ARANDELA PLANA $\frac{5}{16}$ " DIAMETER x $\frac{3}{4}$ " x $\frac{1}{16}$ "		20 PCS
F	LOCK WASHER/ RONDELLE DE BLOCAGE/ ARANDELA DE BLOQUEO $\frac{5}{16}$ " DIAMETER x $\frac{3}{4}$ " x $\frac{1}{16}$ "		20 PCS
G	BOLT/ BOULON/ TORNILLO $\frac{5}{16}$ " DIAMETER x 2" LENGTH		10 PCS
H	ALLEN KEY/ CLÉ ALLEN/LLAVE INGLESA ALLEN 3/16"		1 PC
I	SCREW/VIS/TORNILLO #4 x 1" LENGTH		29 PCS
J	BOLT/ BOULON/ TORNILLO $\frac{5}{16}$ " DIAMETER x $1\frac{3}{16}$ " LENGTH		2 PCS
K	BOLT/ BOULON/ TORNILLO $\frac{5}{16}$ " DIAMETER x $2\frac{1}{2}$ " LENGTH		8 PCS

### LIST OF PARTS AND HARDWARE/ LISTE DES PIÈCES ET DU MATÉRIEL/ LISTA DE PIEZAS Y HARDWARE

NO#/ NOMBRE/ NÚMERO	DESCRIPTION/ DESCRIPTION/ DESCRIPCIÓN		QUANTITY/ QUANTITÉ/ CANTIDAD
1	HEADBOARD PANEL/PANNEAU DE TÊTE DE LIT/ PANEL DE CABECERO		1 PC
2	BOTTOM STRETCHER/ÉTIREUSE INFÉRIEURE/ CAMILLA INFERIOR		1 PC
3	LEFT HEADBOARD LEG/JAMBE DE TÊTE DE LIT GAUCHE/ PIERNA IZQUIERDA DEL CABECERO		1 PC
4	RIGHT HEADBOARD LEG/PIED DE TÊTE DE LIT DROIT/ PATAS DEL CABECERO DERECHO		1 PC
5	WOODEN MENDING PLATE/PLAQUE DE RÉPARATION EN BOIS/PLACA DE MADERA PARA MENDER		2 PCS
6	FOOTBOARD/ PIED DE LIT/ ESTRIBO		1 PC
7	SIDE RAIL/RAIL LATÉRAL/CARRIL LATERAL		2 PCS
8	SIDE RAIL CLEATS/RAILS LATÉRAUX/ TAPAS DE RIEL LATERAL		2 PCS
9	SLAT ROLL (INCLUDED 13 PCS)/ROULEAU DE FENTE/ ROLLO DE RANURA		1 SET
10	BOTTOM SLAT/LAME INFÉRIEURE/LLANTA INFERIOR		3 PCS
11	SLAT SUPPORT LEG/JAMBE DE SUPPORT À LATTES/ PATAS DE SOPORTE DE LAMAS		9 PCS
12	BULB HOLDER/ PORTE-AMPOULE/ PORTALÁMPARAS		2 PCS
13	LAMP SHADE/ FORME DE LA LAMPE/ PANTALLA DE LÁMPARA		2 PCS
14	(OUTPUT: 12V-MAX:3W) LED LIGHT/LUMIÈRE LED/LUZ LED		2 PCS

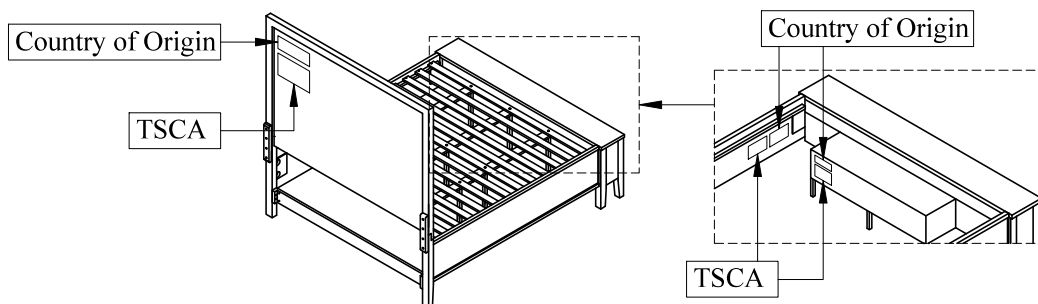

# ASSEMBLY INSTRUCTIONS INSTRUCTIONS DE MONTAGE INSTRUCCIONES DE MONTAJE

CAL. KING LIGHTED PANEL BED W/ STORAGE FOOTBOARD

Note:

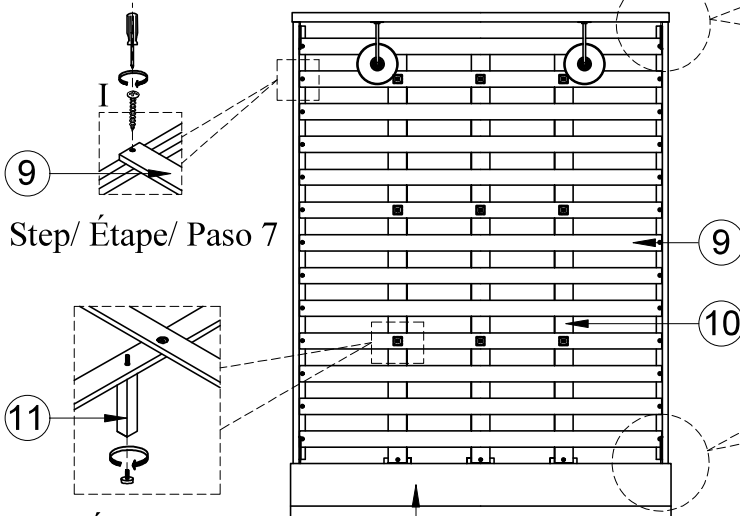
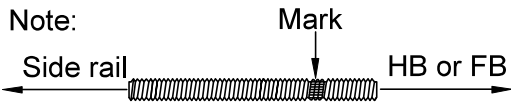

Step/ Étape/ Paso 7

Step/ Étape/ Paso 8

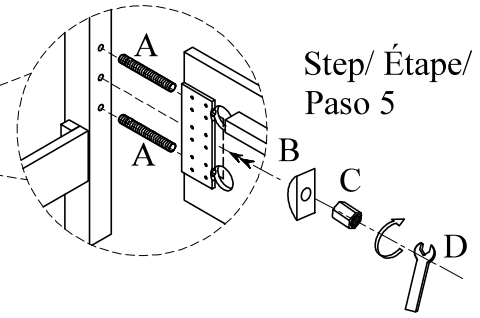

Step/ Étape/  
Paso 5

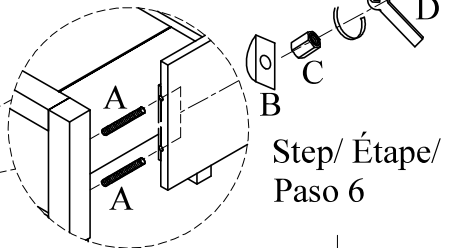

Step/ Étape/  
Paso 6

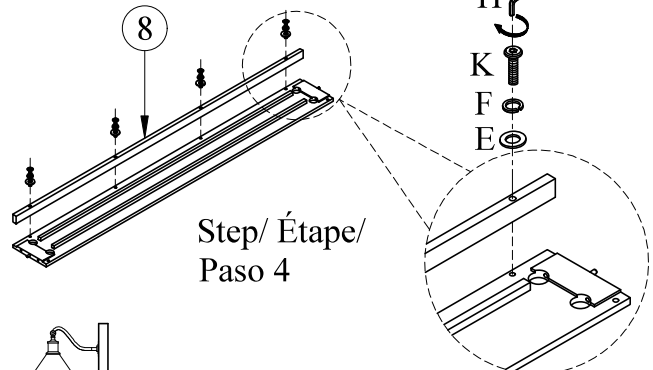
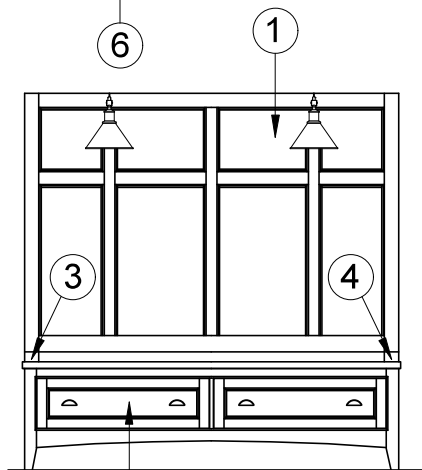

Step/ Étape/  
Paso 4



WARNING:  
ONLY USE THE HAND  
TOOLS PROVIDED

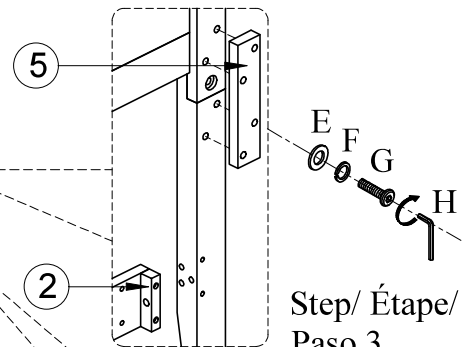
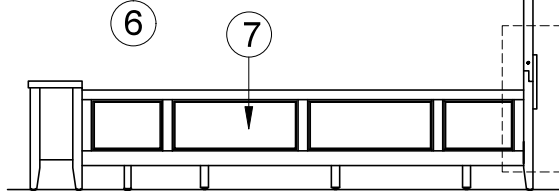

Step/ Étape/  
Paso 3

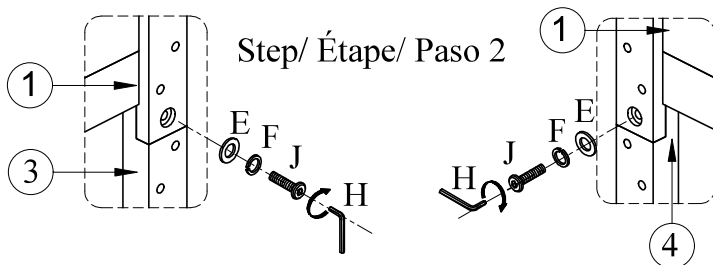

Step/ Étape/ Paso 2

Step/ Étape/ Paso 1

ASSEMBLY INSTRUCTIONS  
INSTRUCTIONS DE MONTAGE  
INSTRUCCIONES DE MONTAJE

CAL. KING LIGHTED PANEL BED W/ STORAGE FOOTBOARD

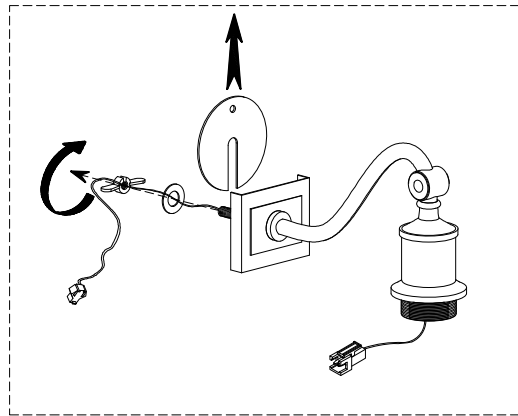

Step/ Étape/ Paso 9

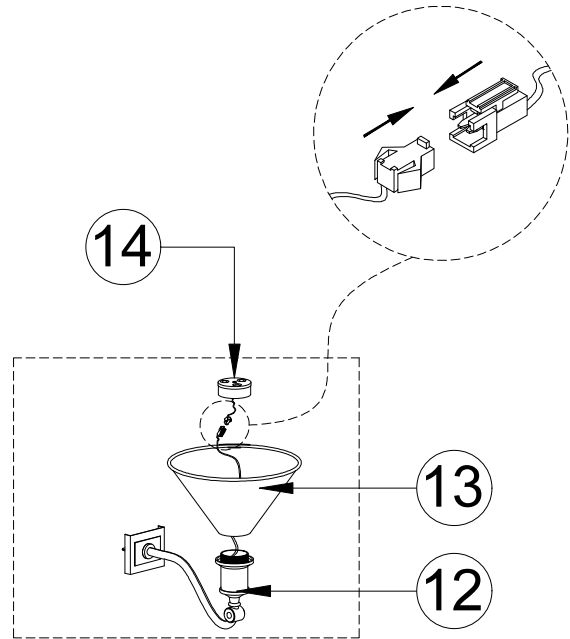

Step/ Étape/ Paso 10

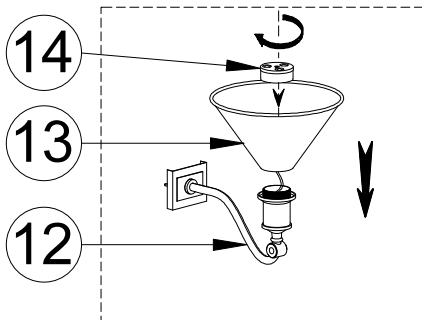

Step/ Étape/ Paso 11

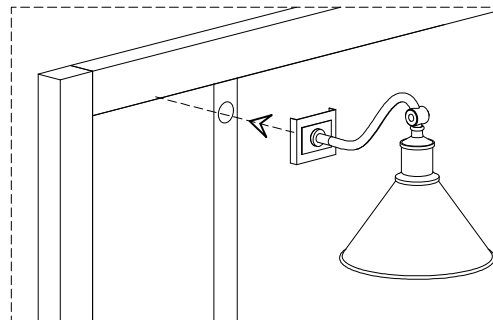

Step/ Étape/ Paso 12

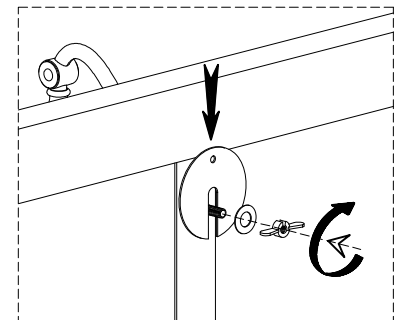

Step/ Étape/ Paso 13

**Note: Tighten the nut by hand only, until the fixture is secure, take care not to overtighten.**

# ASSEMBLY INSTRUCTIONS INSTRUCTIONS DE MONTAGE INSTRUCCIONES DE MONTAJE

CAL. KING LIGHTED PANEL BED W/ STORAGE FOOTBOARD

## WIRING DIAGRAM

Step/ Étape/ Paso 14

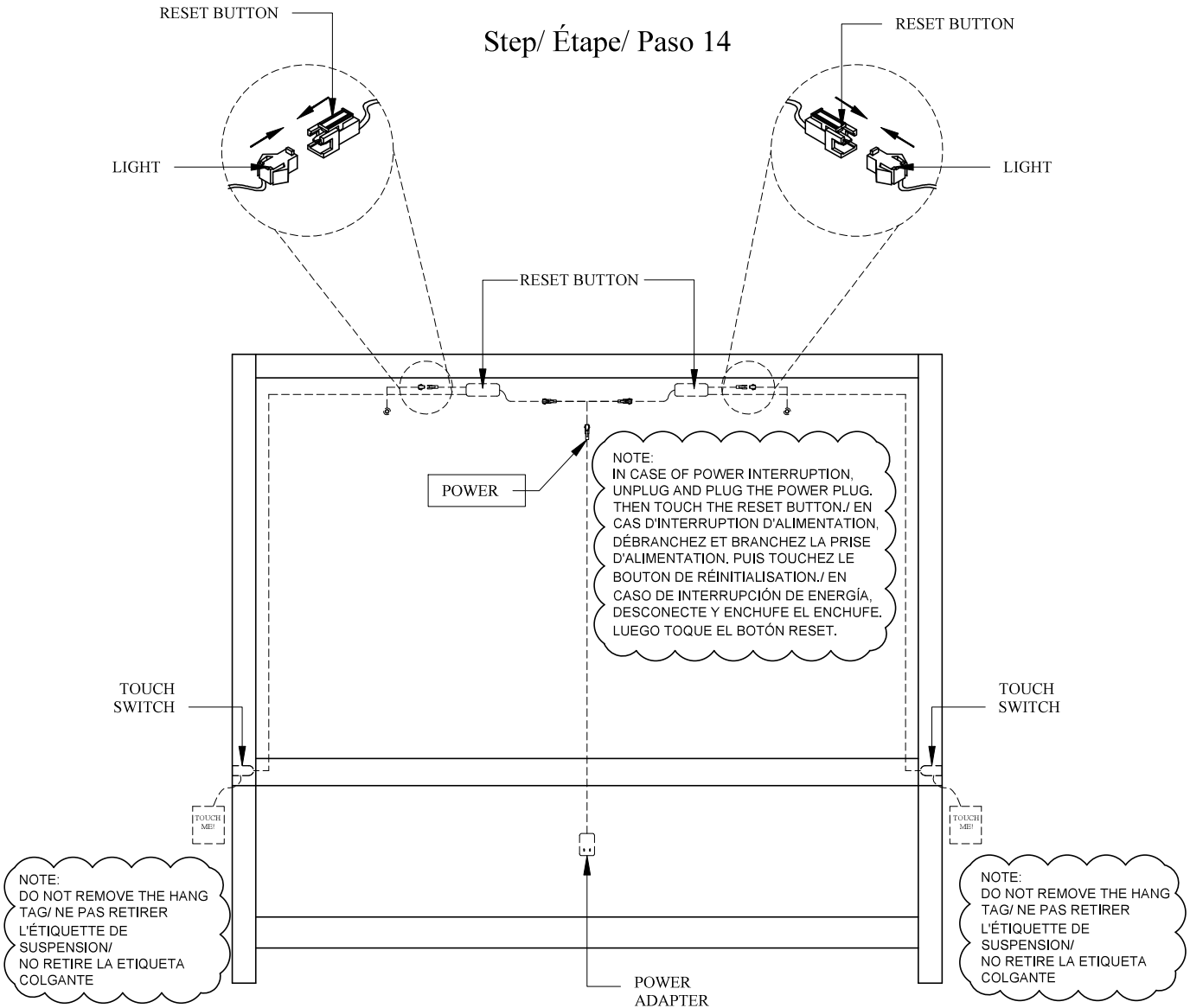

# ASSEMBLY INSTRUCTIONS INSTRUCTIONS DE MONTAGE INSTRUCCIONES DE MONTAJE

## QUEEN LIGHTED PANEL BED

**CAUTION:** PLEASE READ ALL INSTRUCTIONS BEFORE STARTING THE ASSEMBLY OF THIS PRODUCT. THESE PIECES ARE HEAVY. IN ORDER TO PREVENT PERSONAL INJURY AND ENSURE THAT THIS PRODUCT IS NOT DAMAGED DURING THE ASSEMBLY PROCESS, IT IS STRONGLY RECOMMENDED TO ENLIST THE ASSISTANCE OF ONE OR MORE PERSONS. IN CASE OF EXCESS STAIN, WIPE THE BOTTOM OF THE UNIT BEFORE PLACING ON ANY SURFACE.

**ATTENTION:** VEUILLEZ LIRE TOUTES LES INSTRUCTIONS AVANT DE COMMENCER L'ASSEMBLAGE DE CE PRODUIT. LES PIECES SONT LOURDES. POUR EVITER TOUTE BLESSURE ET POUR VOUS ASSURER QUE LE PRODUIT N'EST PAS ENDOMMAGE' PENDANT L'ASSEMBLAGE, NOUS VOUS RECOMMANDONS DE FAIRE APPEL A UNE OU PLUSIEURS AUTRES PERSONNES. EN CAS DE TACHE EXCESSIVE, ESSUYEZ LE FOND DE L'UNITE' AVANT LE PLACEMENT SUR N'IMPORTE QUELLE SURFACE.

**CUIDADO:** FAVOR DE LEER TODAS LAS INSTRUCCIONES ANTES DE ENSAMBLAR SU PRODUCTO, ESTAS. PIEZAS SON PESADAS. PARA PREVENIR HERIDAS PERSONALES Y ASEGURAR QUE SU PRODUCTO NO SEA DAN ADO MIENTRAS ES ENSAMBLADO. SE RECOMIENDA LA ASISTENCIA DE UNA O MAUS PERSONAS.

**WARNING:** PROTECTIVE GLIDE IS PLACED UNDER EACH LEG OF THE FURNITURE TO RESIST SCRATCHES ON FLOOR SURFACE. SOME FLOOR SURFACES CAN BE EXTRA SENSITIVE TO SCRATCHES AND MARKINGS, IF YOU ARE NOT SURE CONSULT WITH YOUR DEALER.  
AVERTISSEMENT. LES PIEDS DES MEUBLES SONT MUNIS DE PATINS DESTINES A PROTEGER LE PLANCHER. CERTAINS REVETEMENTS DE SOL PEUVENT ETRE TRES FRAGILES. EN CAS DE DOUTE. CONSULTER LE MARCHAND.

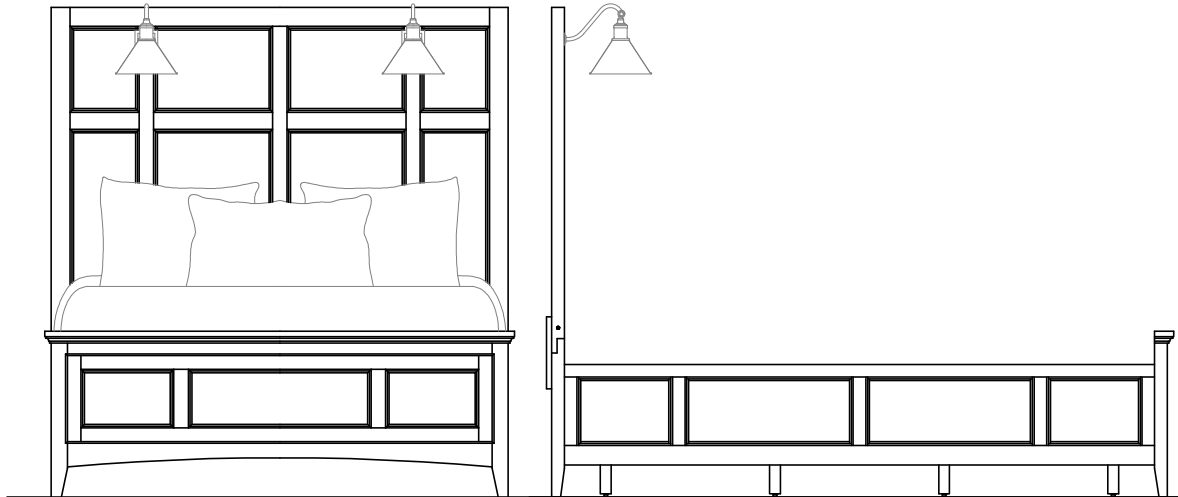











NOTE:  
ASSEMBLE UNIT ON A SOFT SURFACE.  
ASSEMBLEZ L'UNITÉ SUR UNE SURFACE MOLLE.  
ENSAMBLE LA UNIDAD EN UNA SUPERFICIE PLANA Y SUAVE.

DO NOT TIGHTEN BOLTS UNTIL **ALL PARTS AND HARDWARE OF** THE UNIT ARE ASSEMBLED.  
NE SERREZ PAS LES BOULONS JUSQU'À CE QUE L'UNITÉ SOIT COMPLÈTEMENT ASSEMBLÉE.  
NO APRIETE LOS TORNILLOS HASTA QUE LA UNIDAD ESTE COMPLETAMENTE ENSAMBLADA.











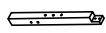

# ASSEMBLY INSTRUCTIONS INSTRUCTIONS DE MONTAGE INSTRUCCIONES DE MONTAJE

## QUEEN LIGHTED PANEL BED

### LIST OF PARTS AND HARDWARE/ LISTE DES PIÈCES ET DU MATÉRIEL/ LISTA DE PIEZAS Y HARDWARE

NO#/ NOMBRE/ NÚMERO	DESCRIPTION/ DESCRIPTION/ DESCRIPCIÓN		QUANTITY/ QUANTITÉ/ CANTIDAD
A	BOLT/ BOULON/ TORNILLO $\frac{5}{16}$ " DIAMETER x 4 $\frac{1}{2}$ " LENGTH		8 PCS
B	CURVED WASHER/RONDELLE COURBE/ ARANDELA CURVA $\frac{5}{16}$ " DIAMETER		8 PCS
C	NUT/ÉCROU/NUEZ $\frac{5}{16}$ " DIAMETER		8 PCS
D	WRENCH/ CLÉ/LLAVE INGLESA 1/2"		1 PC
E	FLAT WASHER/ RONDELLE PLATE/ ARANDELA PLANA $\frac{5}{16}$ " DIAMETER x $\frac{3}{4}$ " x $\frac{1}{16}$ "		12 PCS
F	LOCK WASHER/ RONDELLE DE BLOPAGE/ ARANDELA DE BLOQUEO $\frac{5}{16}$ " DIAMETER x $\frac{1}{2}$ " x $\frac{1}{16}$ "		12 PCS
G	BOLT/ BOULON/ TORNILLO $\frac{5}{16}$ " DIAMETER x 2" LENGTH		10 PCS
H	ALLEN KEY/ CLÉ ALLEN/LLAVE INGLESA ALLEN 3/16"		1 PC
I	SCREW/VIS/TORNILLO #4 x 1" LENGTH		28 PCS
J	BOLT/ BOULON/ TORNILLO $\frac{5}{16}$ " DIAMETER x 1 $\frac{3}{16}$ " LENGTH		2 PCS

### LIST OF PARTS AND HARDWARE/ LISTE DES PIÈCES ET DU MATÉRIEL/ LISTA DE PIEZAS Y HARDWARE

NO#/ NOMBRE/ NÚMERO	DESCRIPTION/ DESCRIPTION/ DESCRIPCIÓN		QUANTITY/ QUANTITÉ/ CANTIDAD
1	HEADBOARD PANEL/PANNEAU DE TÊTE DE LIT/ PANEL DE CABECERO		1 PC
2	BOTTOM STRETCHER/ÉTIREUSE INFÉRIEURE/ CAMILLA INFERIOR		1 PC
3	LEFT HEADBOARD LEG/JAMBE DE TÊTE DE LIT GAUCHE/ PIERNA IZQUIERDA DEL CABECERO		1 PC
4	RIGHT HEADBOARD LEG/PIED DE TÊTE DE LIT DROIT/ PATAS DEL CABECERO DERECHO		1 PC
5	WOODEN MENDING PLATE/PLAQUE DE RÉPARATION EN BOIS/PLACA DE MADERA PARA MENDER		2 PCS
6	FOOTBOARD/ PIED DE LIT/ ESTRIBO		1 PC
7	SIDE RAIL/RAIL LATÉRAL/CARRIL LATERAL		2 PCS
8	SLAT/LAMELLE/LAMA		4 PCS
9	SLAT SUPPORT LEG/JAMBE DE SUPPORT À LATTES/ PATAS DE SOPORTE DE LAMAS		4 PCS
10	BULB HOLDER/ PORTE-AMPOULE/ PORTALÁMPARAS		2 PCS
11	LAMP SHADE/ FORME DE LA LAMPE/ PANTALLA DE LÁMPARA		2 PCS
12	(OUTPUT: 12V-MAX:3W) LED LIGHT/LUMIÈRE LED/LUZ LED		2 PCS

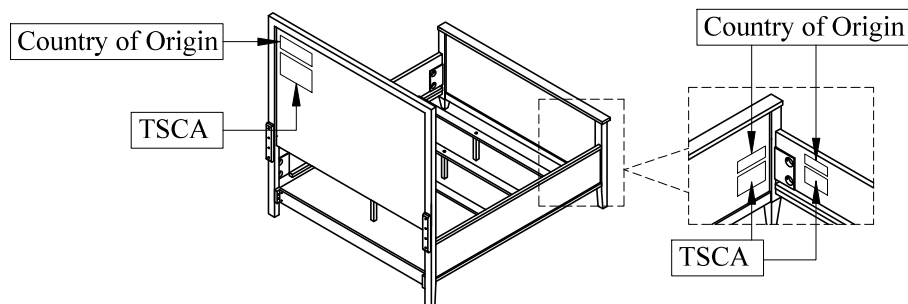

# ASSEMBLY INSTRUCTIONS INSTRUCTIONS DE MONTAGE INSTRUCCIONES DE MONTAJE

QUEEN LIGHTED PANEL BED

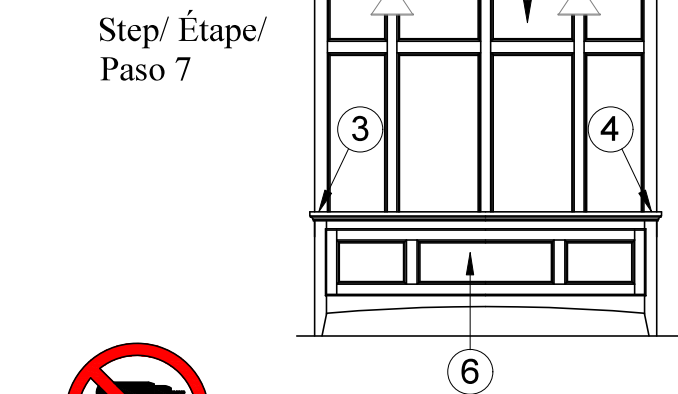
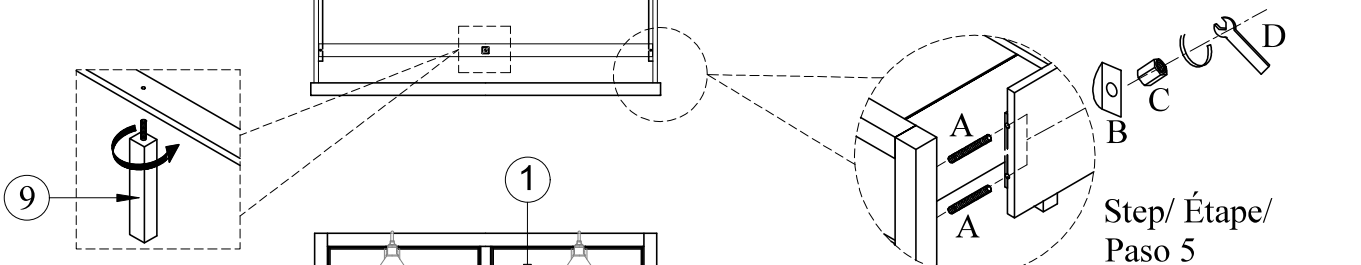
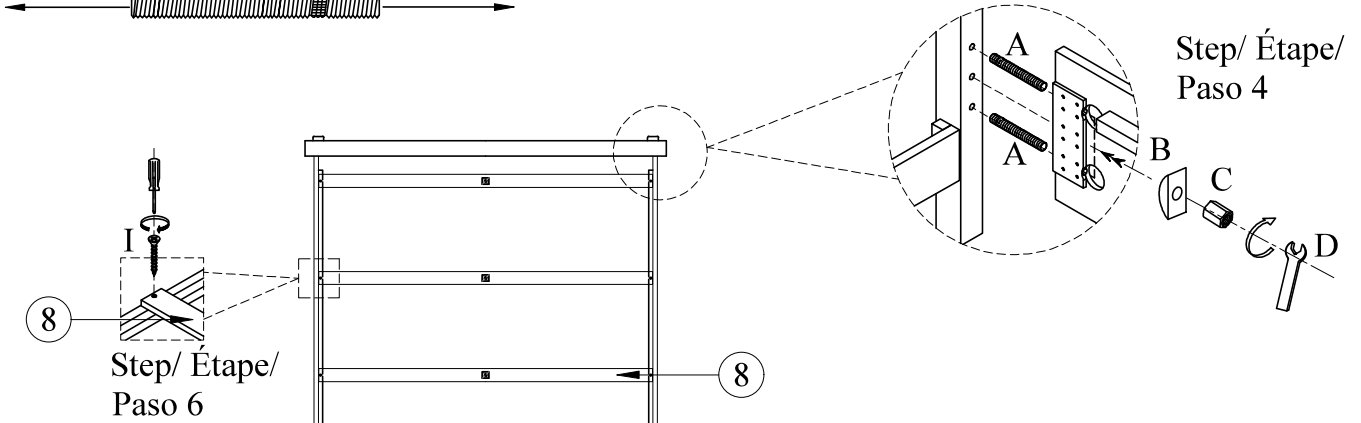
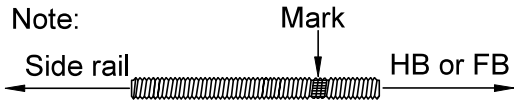

WARNING:  
ONLY USE THE HAND  
TOOLS PROVIDED

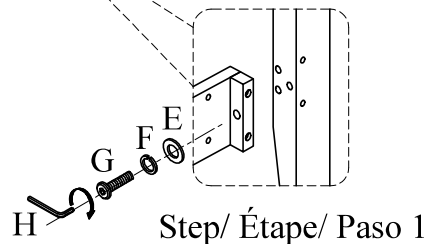
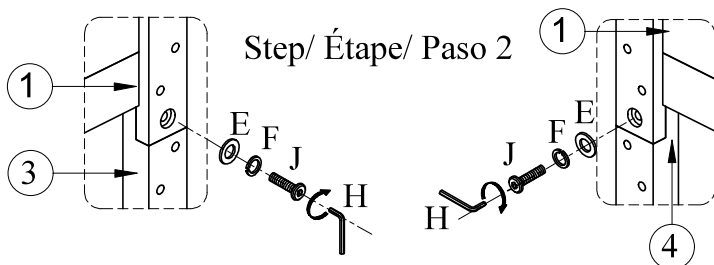
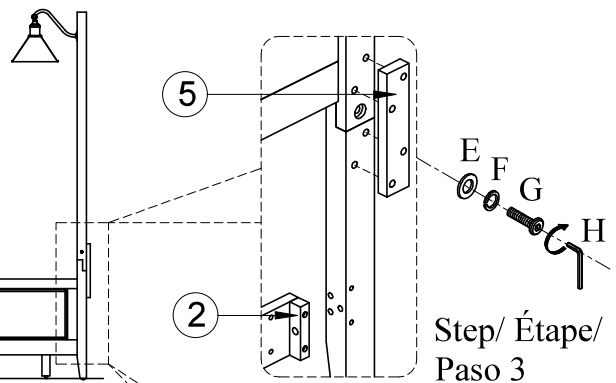

ASSEMBLY INSTRUCTIONS  
INSTRUCTIONS DE MONTAGE  
INSTRUCCIONES DE MONTAJE

QUEEN LIGHTED PANEL BED

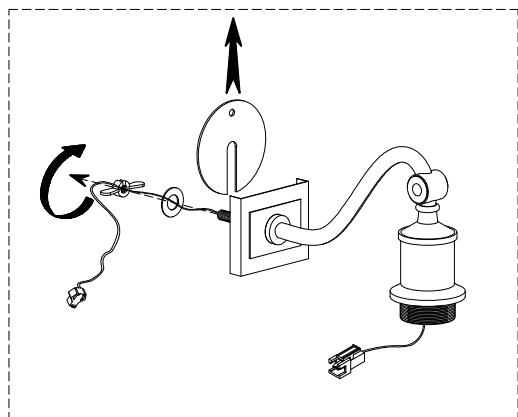

Step/ Étape/ Paso 8

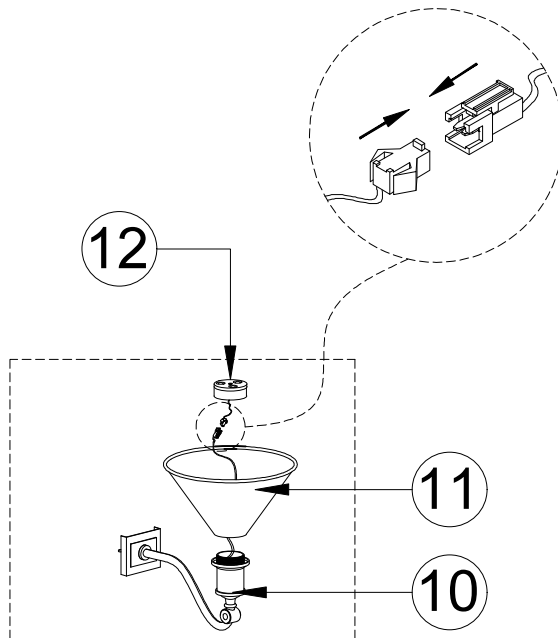

Step/ Étape/ Paso 9

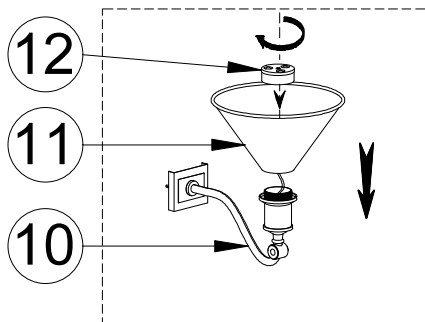

Step/ Étape/ Paso 10

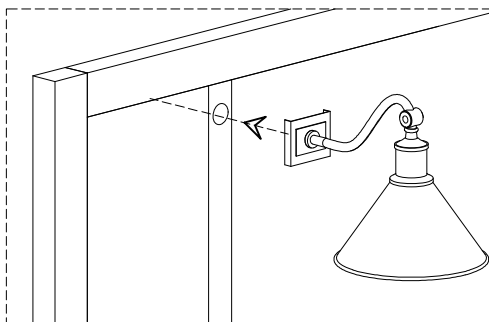

Step/ Étape/ Paso 11

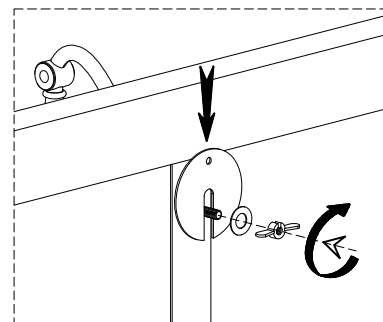

Step/ Étape/ Paso 12

**Note: Tighten the nut by hand only, until the fixture is secure, take care not to overtighten.**

# ASSEMBLY INSTRUCTIONS INSTRUCTIONS DE MONTAGE INSTRUCCIONES DE MONTAJE

QUEEN LIGHTED PANEL BED

## WIRING DIAGRAM

Step/ Étape/ Paso 13

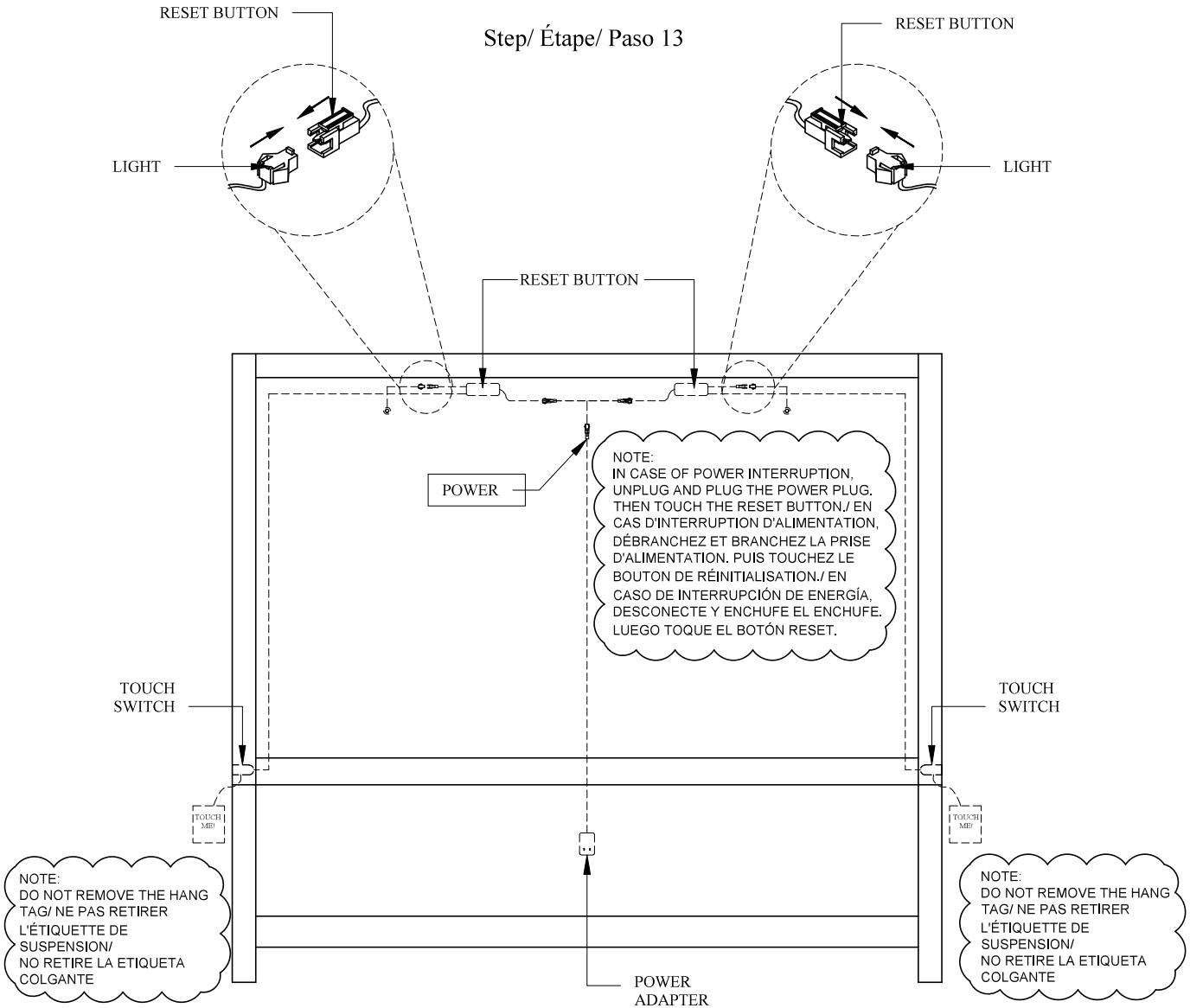

# ASSEMBLY INSTRUCTIONS INSTRUCTIONS DE MONTAGE INSTRUCCIONES DE MONTAJE

## KING LIGHTED PANEL BED

**CAUTION:** PLEASE READ ALL INSTRUCTIONS BEFORE STARTING THE ASSEMBLY OF THIS PRODUCT. THESE PIECES ARE HEAVY. IN ORDER TO PREVENT PERSONAL INJURY AND ENSURE THAT THIS PRODUCT IS NOT DAMAGED DURING THE ASSEMBLY PROCESS, IT IS STRONGLY RECOMMENDED TO ENLIST THE ASSISTANCE OF ONE OR MORE PERSONS. IN CASE OF EXCESS STAIN, WIPE THE BOTTOM OF THE UNIT BEFORE PLACING ON ANY SURFACE.

**ATTENTION:** VEUILLEZ LIRE TOUTES LES INSTRUCTIONS AVANT DE COMMENCER L'ASSEMBLAGE DE CE PRODUIT. LES PIECES SONT LOURDES. POUR EVITER TOUTE BLESSURE ET POUR VOUS ASSURER QUE LE PRODUIT N'EST PAS ENDOMMAGE' PENDANT L'ASSEMBLAGE, NOUS VOUS RECOMMANDONS DE FAIRE APPEL A UNE OU PLUSIEURS AUTRES PERSONNES. EN CAS DE TACHE EXCESSIVE, ESSUYEZ LE FOND DE L'UNITE' AVANT LE PLACEMENT SUR N'IMPORTE QUELLE SURFACE.

**CUIDADO:** FAVOR DE LEER TODAS LAS INSTRUCCIONES ANTES DE ENSAMBLAR SU PRODUCTO, ESTAS. PIEZAS SON PESADAS. PARA PREVENIR HERIDAS PERSONALES Y ASEGURAR QUE SU PRODUCTO NO SEA DAN ADO MIENTRAS ES ENSAMBLADO. SE RECOMIENDA LA ASISTENCIA DE UNA O MAUS PERSONAS.

**WARNING:** PROTECTIVE GLIDE IS PLACED UNDER EACH LEG OF THE FURNITURE TO RESIST SCRATCHES ON FLOOR SURFACE. SOME FLOOR SURFACES CAN BE EXTRA SENSITIVE TO SCRATCHES AND MARKINGS, IF YOU ARE NOT SURE CONSULT WITH YOUR DEALER.  
AVERTISSEMENT. LES PIEDS DES MEUBLES SONT MUNIS DE PATINS DESTINES A PROTEGER LE PLANCHER. CERTAINS REVETEMENTS DE SOL PEUVENT ETRE TRES FRAGILES. EN CAS DE DOUTE. CONSULTER LE MARCHAND.

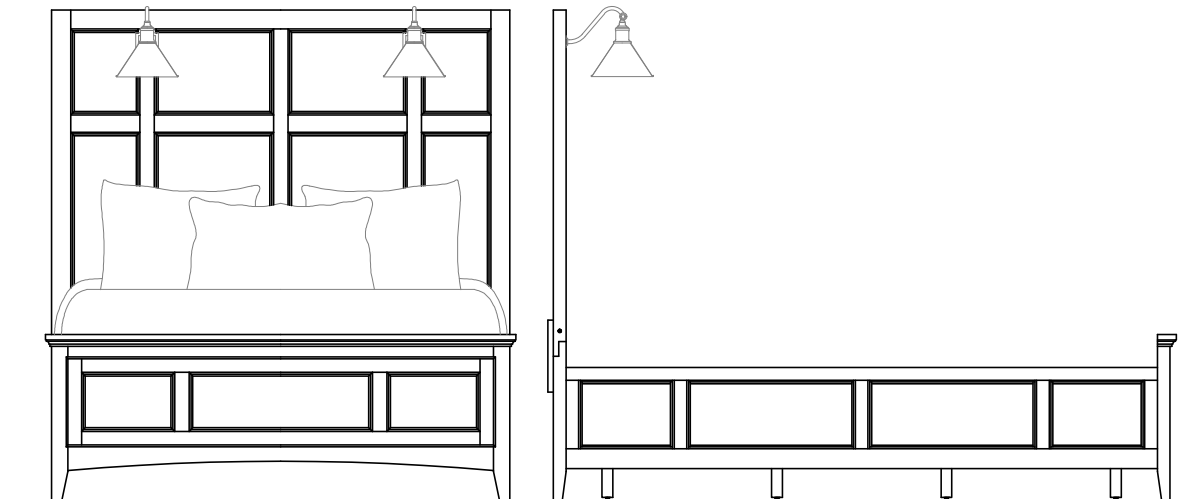











NOTE:  
ASSEMBLE UNIT ON A SOFT SURFACE.  
ASSEMBLEZ L'UNITE' SUR UNE SURFACE MOLLE.  
ENSAMBLE LA UNIDAD EN UNA SUPERFICIE PLANA Y SUAVE.

DO NOT TIGHTEN BOLTS UNTIL **ALL PARTS AND HARDWARE OF THE UNIT ARE ASSEMBLED.**  
NE SERREZ PAS LES BOULONS JUSQU'À CE QUE L'UNITE' SOIT COMPLÈTEMENT ASSEMBLÉE.  
NO APRIETE LOS TORNILLOS HASTA QUE LA UNIDAD ESTE COMPLETAMENTE ENSAMBLADA.













# ASSEMBLY INSTRUCTIONS INSTRUCTIONS DE MONTAGE INSTRUCCIONES DE MONTAJE

## KING LIGHTED PANEL BED

### LIST OF PARTS AND HARDWARE/ LISTE DES PIÈCES ET DU MATÉRIEL/ LISTA DE PIEZAS Y HARDWARE

NO#/ NOMBRE/ NÚMERO	DESCRIPTION/ DESCRIPTION/ DESCRIPCIÓN		QUANTITY/ QUANTITÉ/ CANTIDAD
A	BOLT/ BOULON/ TORNILLO <span style="float: right;"><math>\frac{5}{16}</math>" DIAMETER x <math>4\frac{1}{2}</math>" LENGTH</span>		8 PCS
B	CURVED WASHER/RONDELLE COURBE/ ARANDELA CURVA <span style="float: right;"><math>\frac{5}{16}</math>" DIAMETER</span>		8 PCS
C	NUT/ÉCROU/NUEZ <span style="float: right;"><math>\frac{5}{16}</math>" DIAMETER</span>		8 PCS
D	WRENCH/ CLÉ/LLAVE INGLESA <span style="float: right;">1/2"</span>		1 PC
E	FLAT WASHER/ RONDELLE PLATE/ ARANDELA PLANA <span style="float: right;"><math>\frac{5}{16}</math>" DIAMETER x <math>\frac{3}{4}</math>" x <math>\frac{1}{16}</math>"</span>		12 PCS
F	LOCK WASHER/ RONDELLE DE BLOCAGE/ ARANDELA DE BLOQUEO <span style="float: right;"><math>\frac{5}{16}</math>" DIAMETER x <math>\frac{1}{2}</math>" x <math>\frac{1}{16}</math>"</span>		12 PCS
G	BOLT/ BOULON/ TORNILLO <span style="float: right;"><math>\frac{5}{16}</math>" DIAMETER x 2" LENGTH</span>		10 PCS
H	ALLEN KEY/ CLÉ ALLEN/LLAVE INGLESA ALLEN <span style="float: right;">3/16"</span>		1 PC
I	SCREW/VIS/TORNILLO <span style="float: right;">#4 x 1" LENGTH</span>		28 PCS
J	BOLT/ BOULON/ TORNILLO <span style="float: right;"><math>\frac{5}{16}</math>" DIAMETER x <math>1\frac{3}{16}</math>" LENGTH</span>		2 PCS

### LIST OF PARTS AND HARDWARE/ LISTE DES PIÈCES ET DU MATÉRIEL/ LISTA DE PIEZAS Y HARDWARE

NO#/ NOMBRE/ NÚMERO	DESCRIPTION/ DESCRIPTION/ DESCRIPCIÓN		QUANTITY/ QUANTITÉ/ CANTIDAD
1	HEADBOARD PANEL/PANNEAU DE TÊTE DE LIT/ PANEL DE CABECERO		1 PC
2	BOTTOM STRETCHER/ÉTIREUSE INFÉRIEURE/ CAMILLA INFERIOR		1 PC
3	LEFT HEADBOARD LEG/JAMBE DE TÊTE DE LIT GAUCHE/ PIERNA IZQUIERDA DEL CABECERO		1 PC
4	RIGHT HEADBOARD LEG/PIED DE TÊTE DE LIT DROIT/ PATAS DEL CABECERO DERECHO		1 PC
5	WOODEN MENDING PLATE/PLAQUE DE RÉPARATION EN BOIS/PLACA DE MADERA PARA MENDER		2 PCS
6	FOOTBOARD/ PIED DE LIT/ ESTRIBO		1 PC
7	SIDE RAIL/RAIL LATÉRAL/CARRIL LATERAL		2 PCS
8	SLAT/LAMELLE/LAMA		4 PCS
9	SLAT SUPPORT LEG/JAMBE DE SUPPORT À LATTES/ PATAS DE SOPORTE DE LAMAS		12 PCS
10	BULB HOLDER/ PORTE-AMPOULE/ PORTALÁMPARAS		2 PCS
11	LAMP SHADE/ FORME DE LA LAMPE/ PANTALLA DE LÁMPARA		2 PCS
12	(OUTPUT: 12V-MAX:3W) LED LIGHT/LUMIÈRE LED/LUZ LED		2 PCS

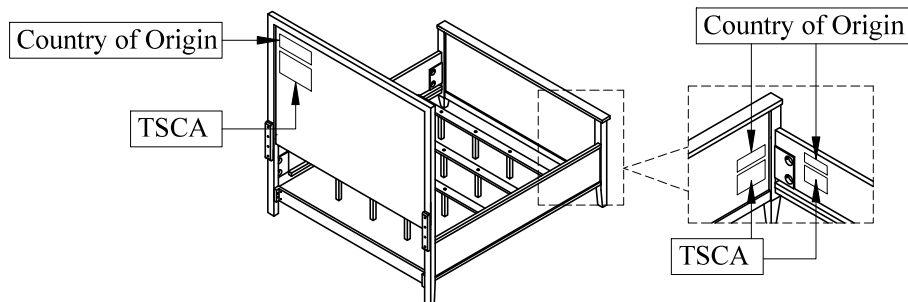

# ASSEMBLY INSTRUCTIONS INSTRUCTIONS DE MONTAGE INSTRUCCIONES DE MONTAJE

KING LIGHTED PANEL BED

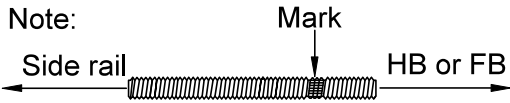

Step/ Étape/  
Paso 4

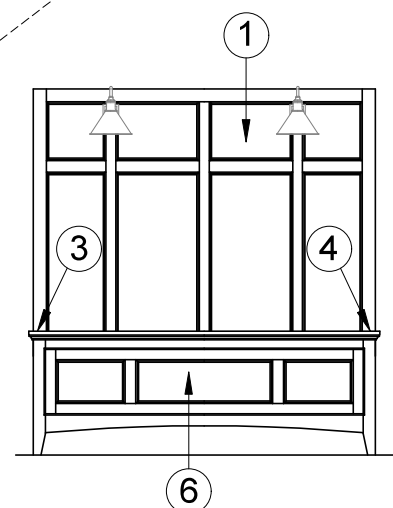
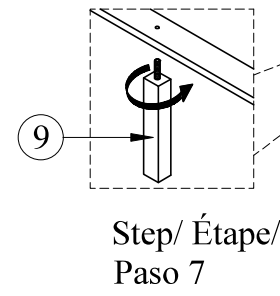
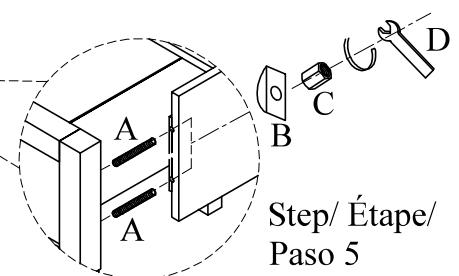
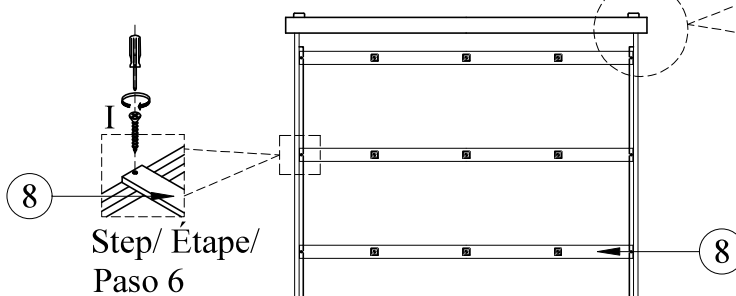
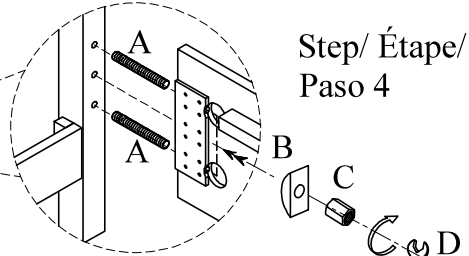

WARNING:  
ONLY USE THE HAND  
TOOLS PROVIDED

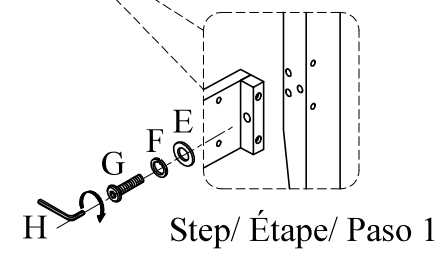
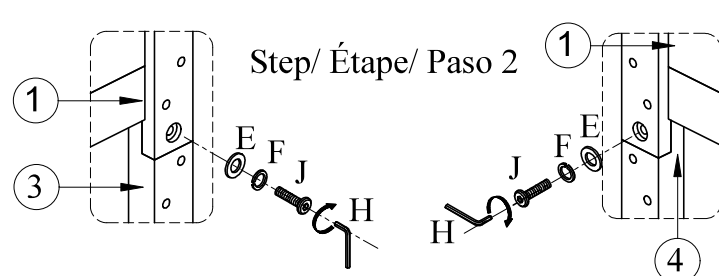
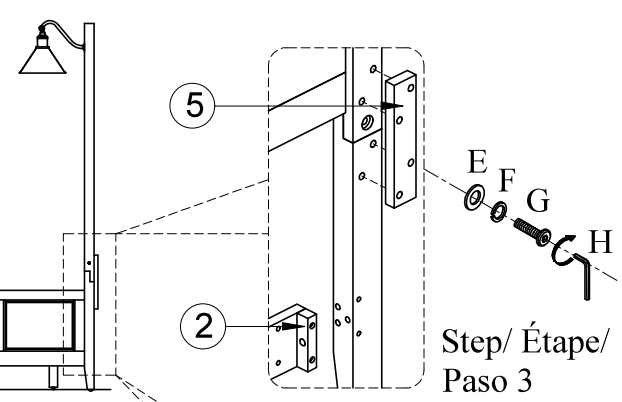

ASSEMBLY INSTRUCTIONS  
INSTRUCTIONS DE MONTAGE  
INSTRUCCIONES DE MONTAJE

KING LIGHTED PANEL BED

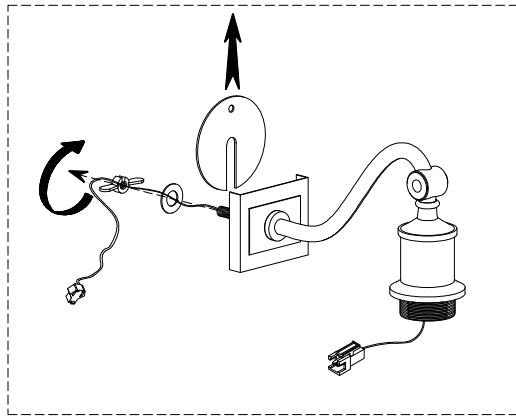

Step/ Étape/ Paso 8

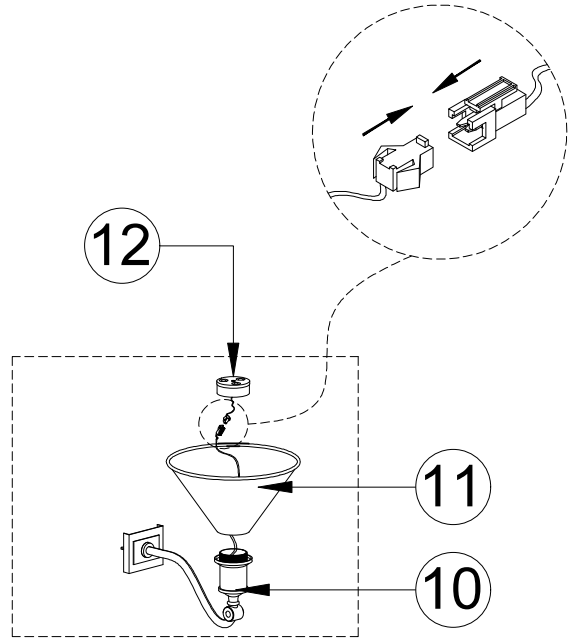

Step/ Étape/ Paso 9

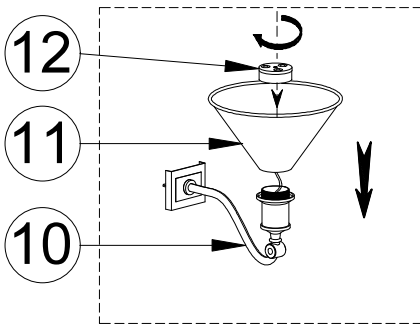

Step/ Étape/ Paso 10

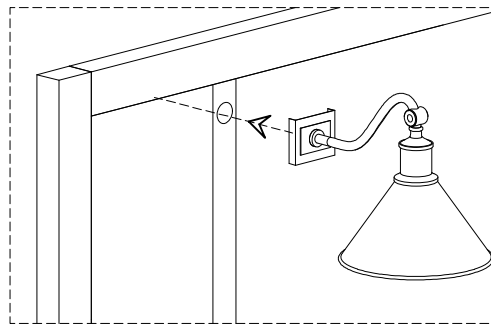

Step/ Étape/ Paso 11

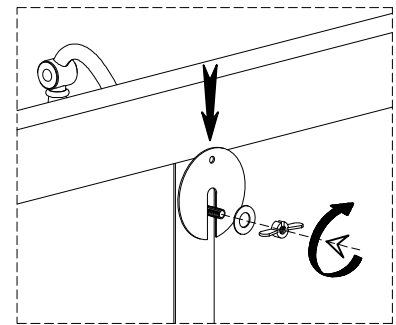

Step/ Étape/ Paso 12

**Note: Tighten the nut by hand only, until the fixture is secure, take care not to overtighten.**

# ASSEMBLY INSTRUCTIONS INSTRUCTIONS DE MONTAGE INSTRUCCIONES DE MONTAJE

KING LIGHTED PANEL BED

## WIRING DIAGRAM

Step/ Étape/ Paso 13

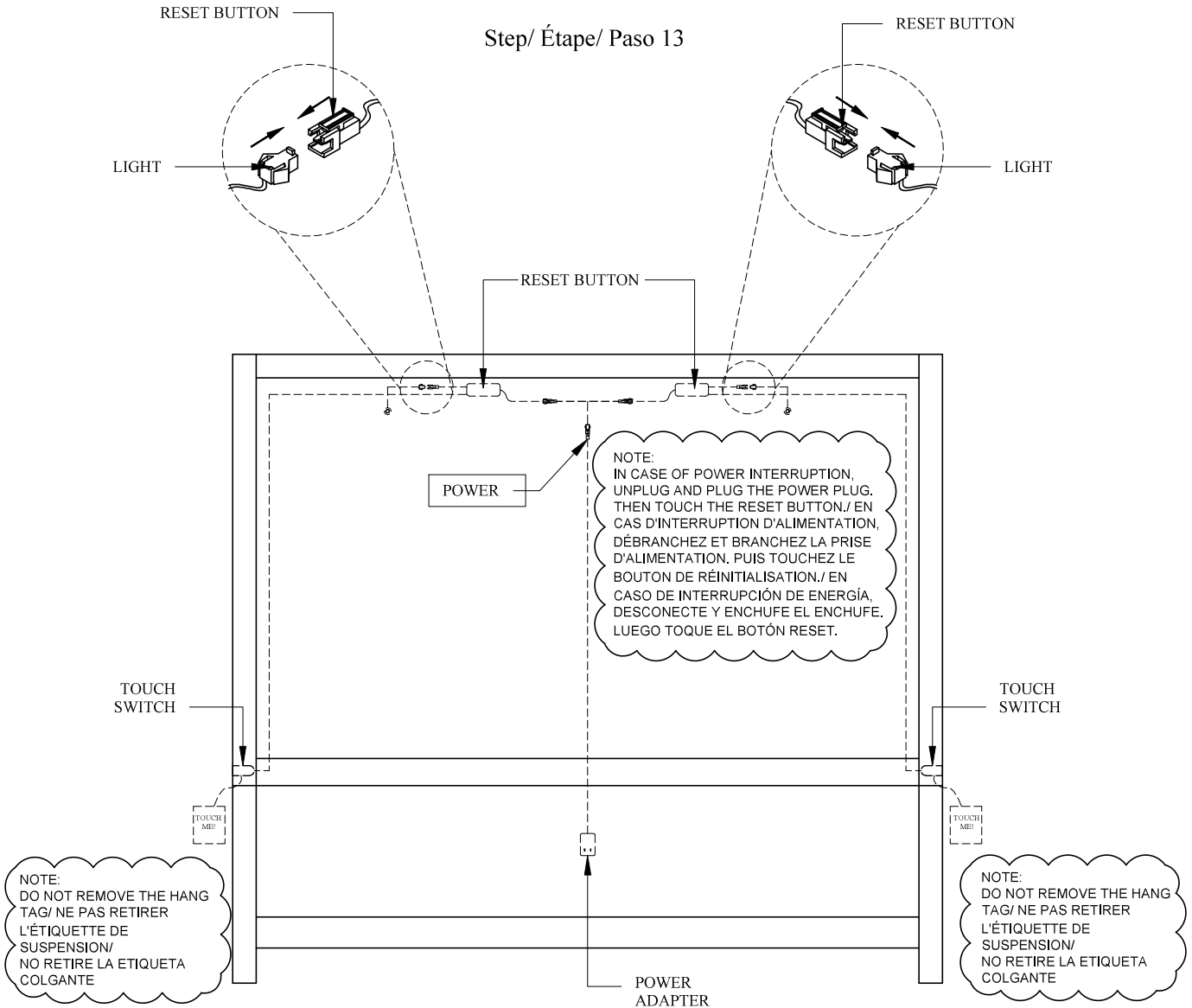

# ASSEMBLY INSTRUCTIONS INSTRUCTIONS DE MONTAGE INSTRUCCIONES DE MONTAJE

CAL. KING LIGHTED PANEL BED

**CAUTION:** PLEASE READ ALL INSTRUCTIONS BEFORE STARTING THE ASSEMBLY OF THIS PRODUCT. THESE PIECES ARE HEAVY. IN ORDER TO PREVENT PERSONAL INJURY AND ENSURE THAT THIS PRODUCT IS NOT DAMAGED DURING THE ASSEMBLY PROCESS, IT IS STRONGLY RECOMMENDED TO ENLIST THE ASSISTANCE OF ONE OR MORE PERSONS. IN CASE OF EXCESS STAIN, WIPE THE BOTTOM OF THE UNIT BEFORE PLACING ON ANY SURFACE.

**ATTENTION:** VEUILLEZ LIRE TOUTES LES INSTRUCTIONS AVANT DE COMMENCER L'ASSEMBLAGE DE CE PRODUIT. LES PIECES SONT LOURDES. POUR EVITER TOUTE BLESSURE ET POUR VOUS ASSURER QUE LE PRODUIT N'EST PAS ENDOMMAGE' PENDANT L'ASSEMBLAGE, NOUS VOUS RECOMMANDONS DE FAIRE APPEL A UNE OU PLUSIEURS AUTRES PERSONNES. EN CAS DE TACHE EXCESSIVE, ESSUYEZ LE FOND DE L'UNITE' AVANT LE PLACEMENT SUR N'IMPORTE QUELLE SURFACE.

**CUIDADO:** FAVOR DE LEER TODAS LAS INSTRUCCIONES ANTES DE ENSAMBLAR SU PRODUCTO, ESTAS. PIEZAS SON PESADAS. PARA PREVENIR HERIDAS PERSONALES Y ASEGURAR QUE SU PRODUCTO NO SEA DAN ADO MIENTRAS ES ENSAMBLADO. SE RECOMIENDA LA ASISTENCIA DE UNA O MAUS PERSONAS.

**WARNING:** PROTECTIVE GLIDE IS PLACED UNDER EACH LEG OF THE FURNITURE TO RESIST SCRATCHES ON FLOOR SURFACE. SOME FLOOR SURFACES CAN BE EXTRA SENSITIVE TO SCRATCHES AND MARKINGS, IF YOU ARE NOT SURE CONSULT WITH YOUR DEALER. AVERTISSEMENT. LES PIEDS DES MEUBLES SONT MUNIS DE PATINS DESTINES A PROTEGER LE PLANCHER. CERTAINS REVETEMENTS DE SOL PEUVENT ETRE TRES FRAGILES. EN CAS DE DOUTE. CONSULTER LE MARCHAND.

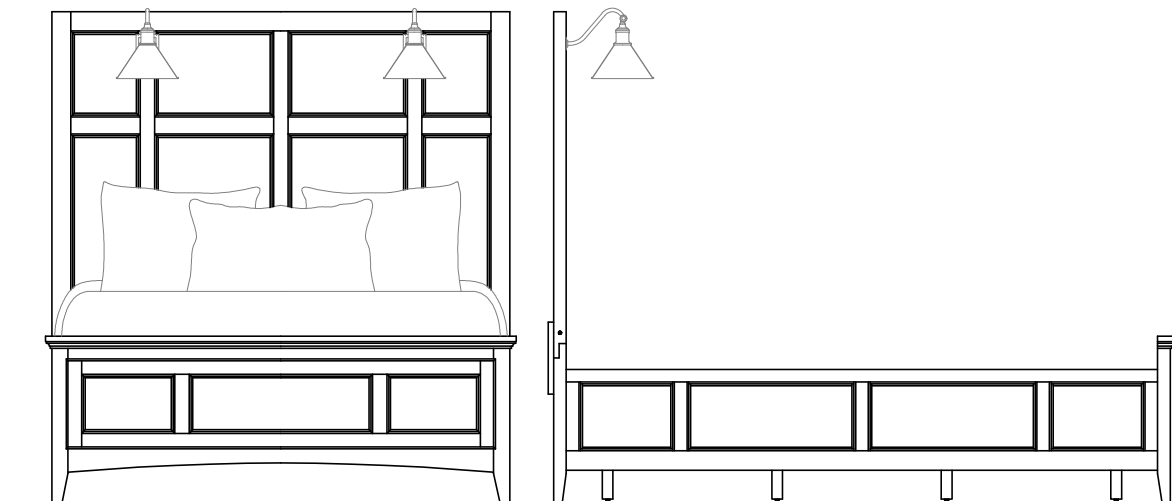











NOTE:  
ASSEMBLE UNIT ON A SOFT SURFACE.  
ASSEMBLEZ L'UNITE' SUR UNE SURFACE MOLLE.  
ENSAMBLE LA UNIDAD EN UNA SUPERFICIE PLANA Y SUAVE.

DO NOT TIGHTEN BOLTS UNTIL **ALL PARTS AND HARDWARE OF** THE UNIT ARE ASSEMBLED.  
NE SERREZ PAS LES BOULONS JUSQU'À CE QUE L'UNITE' SOIT COMPLÈTEMENT ASSEMBLÉE.  
NO APRIETE LOS TORNILLOS HASTA QUE LA UNIDAD ESTE COMPLETAMENTE ENSAMBLADA.











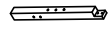

# ASSEMBLY INSTRUCTIONS INSTRUCTIONS DE MONTAGE INSTRUCCIONES DE MONTAJE

## CAL. KING LIGHTED PANEL BED

### LIST OF PARTS AND HARDWARE/ LISTE DES PIÈCES ET DU MATÉRIEL/ LISTA DE PIEZAS Y HARDWARE

NO#/ NOMBRE/ NÚMERO	DESCRIPTION/ DESCRIPTION/ DESCRIPCIÓN		QUANTITY/ QUANTITÉ/ CANTIDAD
A	BOLT/ BOULON/ TORNILLO $\frac{5}{16}$ " DIAMETER x $4\frac{1}{2}$ " LENGTH		8 PCS
B	CURVED WASHER/RONDELLE COURBE/ ARANDELA CURVA $\frac{5}{16}$ " DIAMETER		8 PCS
C	NUT/ÉCROU/NUEZ $\frac{5}{16}$ " DIAMETER		8 PCS
D	WRENCH/ CLÉ/LLAVE INGLESA 1/2"		1 PC
E	FLAT WASHER/ RONDELLE PLATE/ ARANDELA PLANA $\frac{5}{16}$ " DIAMETER x $\frac{3}{4}$ " x $\frac{1}{16}$ "		12 PCS
F	LOCK WASHER/ RONDELLE DE BLOCAGE/ ARANDELA DE BLOQUEO $\frac{5}{16}$ " DIAMETER x $\frac{1}{2}$ " x $\frac{1}{16}$ "		12 PCS
G	BOLT/ BOULON/ TORNILLO $\frac{3}{16}$ " DIAMETER x 2" LENGTH		10 PCS
H	ALLEN KEY/ CLÉ ALLEN/LLAVE INGLESA ALLEN 3/16"		1 PC
I	SCREW/VIS/TORNILLO #4 x 1" LENGTH		28 PCS
J	BOLT/ BOULON/ TORNILLO $\frac{5}{16}$ " DIAMETER x $1\frac{3}{16}$ " LENGTH		2 PCS
K	BOLT/ BOULON/ TORNILLO $\frac{5}{16}$ " DIAMETER x $2\frac{1}{2}$ " LENGTH		8 PCS

### LIST OF PARTS AND HARDWARE/ LISTE DES PIÈCES ET DU MATÉRIEL/ LISTA DE PIEZAS Y HARDWARE

NO#/ NOMBRE/ NÚMERO	DESCRIPTION/ DESCRIPTION/ DESCRIPCIÓN		QUANTITY/ QUANTITÉ/ CANTIDAD
1	HEADBOARD PANEL/PANNEAU DE TÊTE DE LIT/ PANEL DE CABECERO		1 PC
2	BOTTOM STRETCHER/ÉTIREUSE INFÉRIEURE/ CAMILLA INFERIOR		1 PC
3	LEFT HEADBOARD LEG/JAMBE DE TÊTE DE LIT GAUCHE/ PIERNA IZQUIERDA DEL CABECERO		1 PC
4	RIGHT HEADBOARD LEG/PIED DE TÊTE DE LIT DROIT/ PATAS DEL CABECERO DERECHO		1 PC
5	WOODEN MENDING PLATE/PLAQUE DE RÉPARATION EN BOIS/PLACA DE MADERA PARA MENDER		2 PCS
6	FOOTBOARD/ PIED DE LIT/ ESTRIBO		1 PC
7	SIDE RAIL/RAIL LATÉRAL/CARRIL LATERAL		2 PCS
8	SIDE RAIL CLEATS/RAILS LATÉRAUX/ TAPAS DE RIEL LATERAL		2 PCS
9	SLAT/LAMELLE/LAMA		4 PCS
10	SLAT SUPPORT LEG/JAMBE DE SUPPORT À LATTES/ PATAS DE SOPORTE DE LAMAS		12 PCS
11	BULB HOLDER/ PORTE-AMPOULE/ PORTALÁMPARAS		2 PCS
12	LAMP SHADE/ FORME DE LA LAMPE/ PANTALLA DE LÁMPARA		2 PCS
13	(OUTPUT: 12V-MAX:3W) LED LIGHT/LUMIÈRE LED/LUZ LED		2 PCS

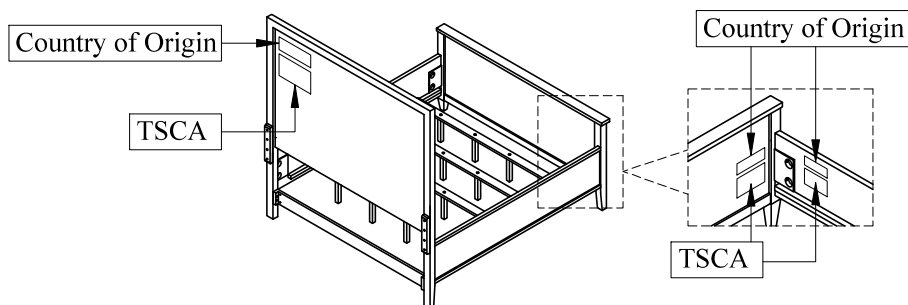

# ASSEMBLY INSTRUCTIONS INSTRUCTIONS DE MONTAGE INSTRUCCIONES DE MONTAJE

CAL. KING LIGHTED PANEL BED

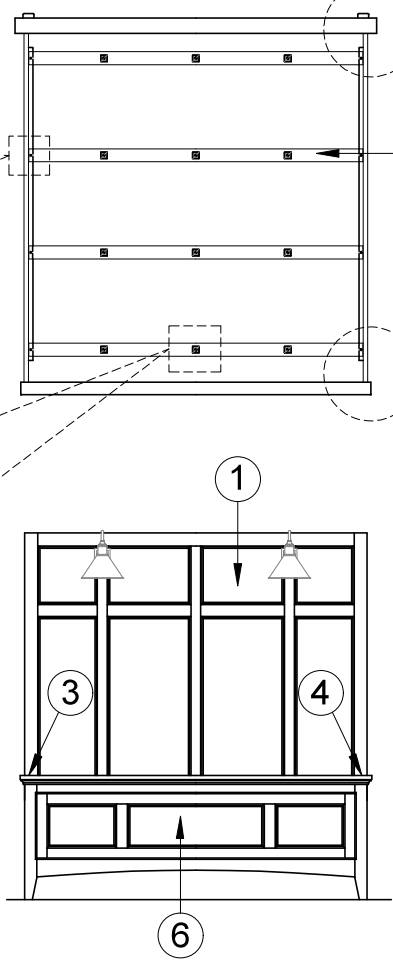
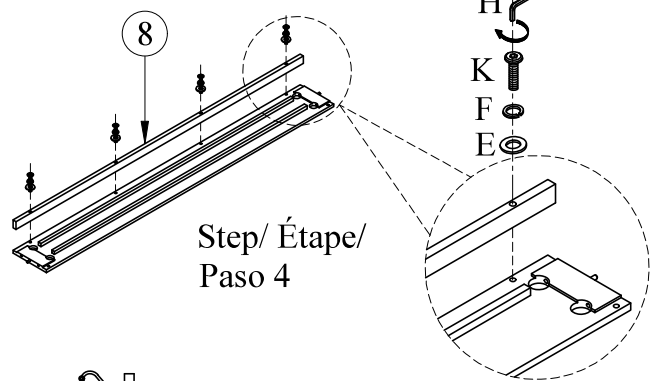
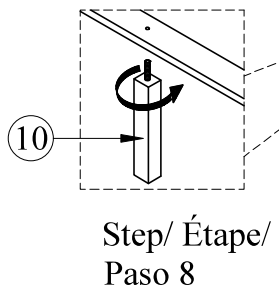
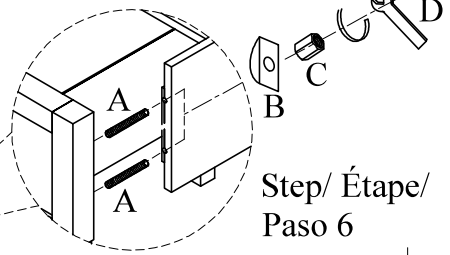
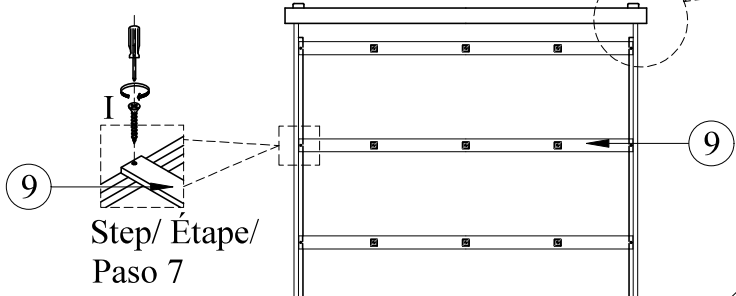
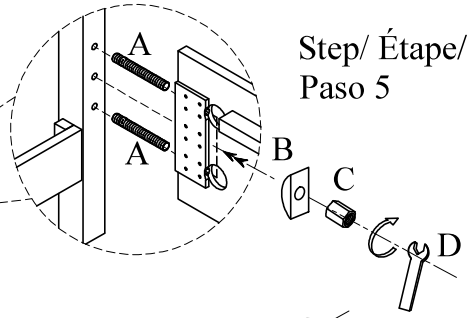
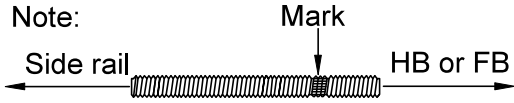

WARNING:  
ONLY USE THE HAND  
TOOLS PROVIDED

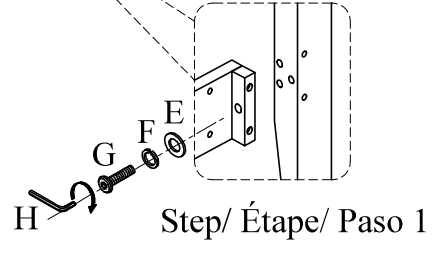
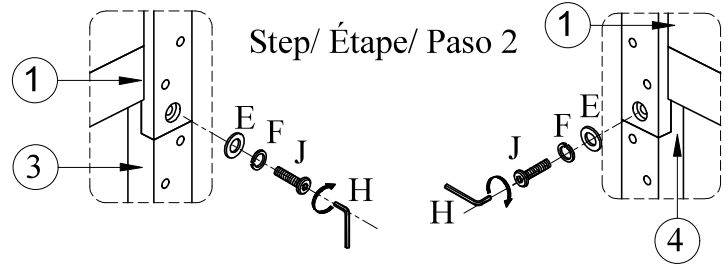
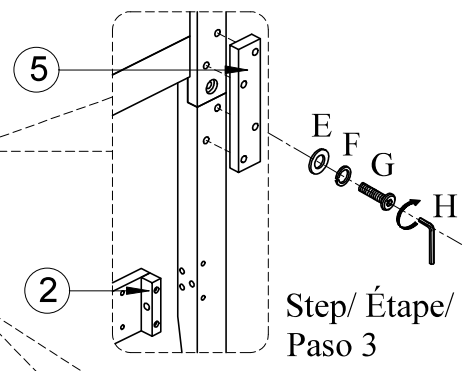

ASSEMBLY INSTRUCTIONS  
INSTRUCTIONS DE MONTAGE  
INSTRUCCIONES DE MONTAJE

CAL. KING LIGHTED PANEL BED

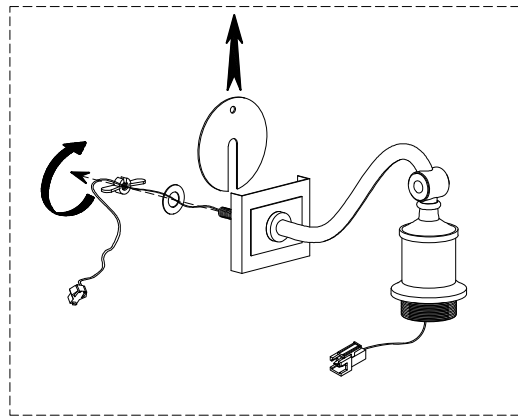

Step/ Étape/ Paso 9

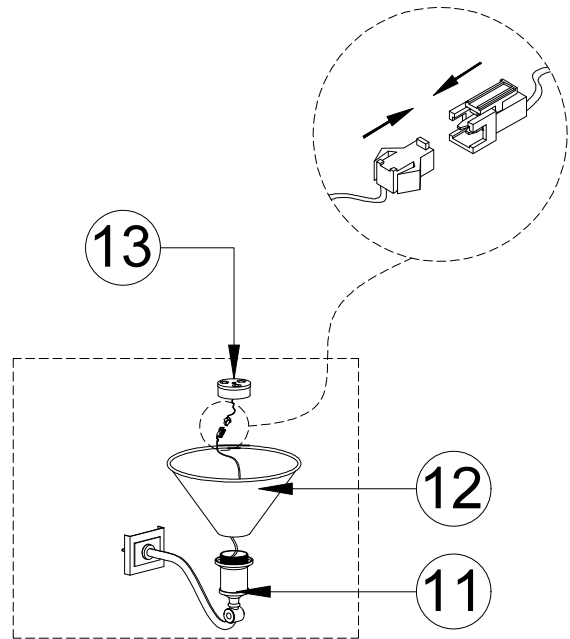

Step/ Étape/ Paso 10

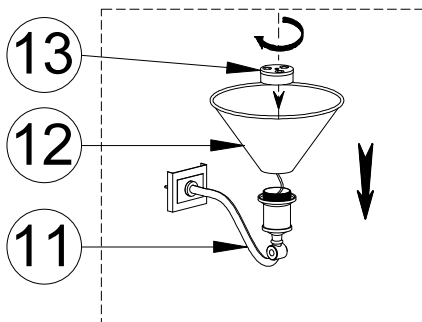

Step/ Étape/ Paso 11

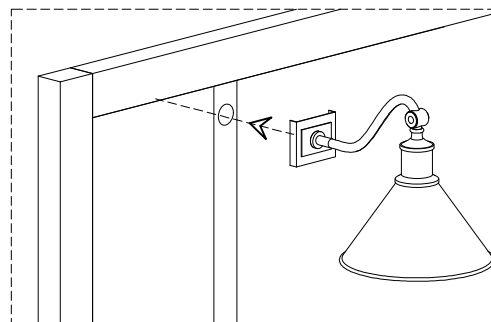

Step/ Étape/ Paso 12

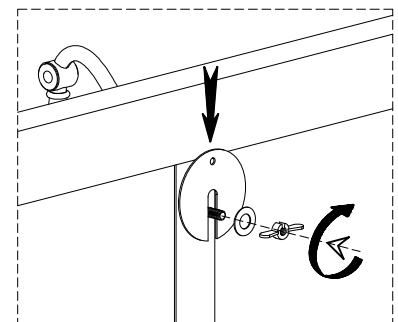

Step/ Étape/ Paso 13

**Note: Tighten the nut by hand only, until the fixture is secure, take care not to overtighten.**

# ASSEMBLY INSTRUCTIONS INSTRUCTIONS DE MONTAGE INSTRUCCIONES DE MONTAJE

CAL. KING LIGHTED PANEL BED

## WIRING DIAGRAM

Step/ Étape/ Paso 14

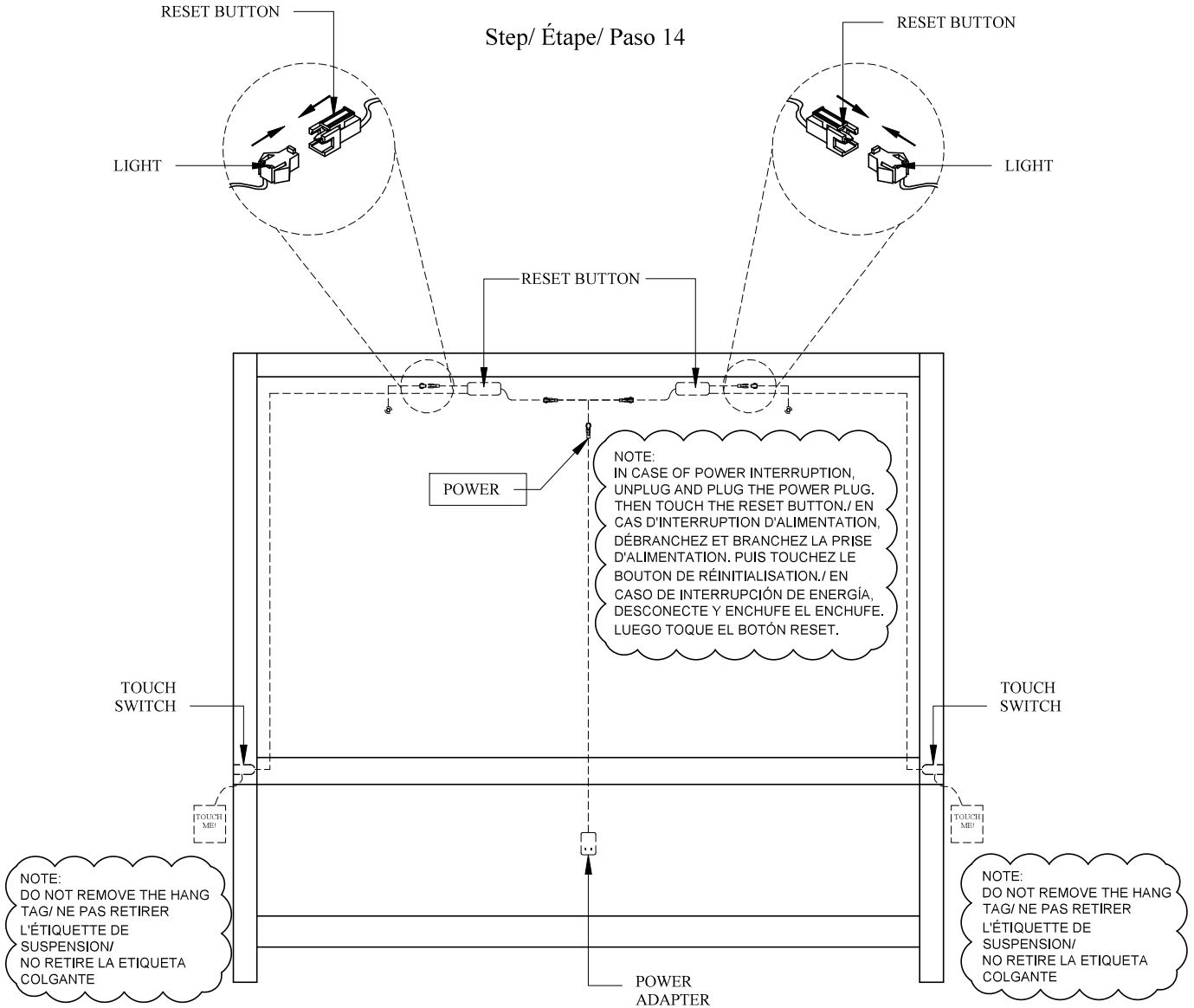

# ASSEMBLY INSTRUCTIONS INSTRUCTIONS DE MONTAGE INSTRUCCIONES DE MONTAJE

QUEEN LIGHTED PANEL BED W/ STORAGE SIDE RAIL

**CAUTION:** PLEASE READ ALL INSTRUCTIONS BEFORE STARTING THE ASSEMBLY OF THIS PRODUCT. THESE PIECES ARE HEAVY. IN ORDER TO PREVENT PERSONAL INJURY AND ENSURE THAT THIS PRODUCT IS NOT DAMAGED DURING THE ASSEMBLY PROCESS, IT IS STRONGLY RECOMMENDED TO ENLIST THE ASSISTANCE OF ONE OR MORE PERSONS. IN CASE OF EXCESS STAIN, WIPE THE BOTTOM OF THE UNIT BEFORE PLACING ON ANY SURFACE.

**ATTENTION:** VEUILLEZ LIRE TOUTES LES INSTRUCTIONS AVANT DE COMMENCER L'ASSEMBLAGE DE CE PRODUIT. LES PIECES SONT LOURDES. POUR EVITER TOUTE BLESSURE ET POUR VOUS, ASSURER QUE LE PRODUIT N'EST PAS ENDOMMAGE' PENDANT L'ASSEMBLAGE, NOUS VOUS RECOMMANDONS DE FAIRE APPEL A UNE OU PLUSIEURS AUTRES PERSONNES. EN CAS DE TACHE EXCESSIVE, ESSUYEZ LE FOND DE L'UNITE' AVANT LE PLACEMENT SUR N'IMPORTE QUELLE SURFACE.

**CUIDADO:** FAVOR DE LEER TODAS LAS INSTRUCCIONES ANTES DE ENSAMBLAR SU PRODUCTO, ESTAS. PIEZAS SON PESADAS. PARA PREVENIR HERIDAS PERSONALES Y ASEGURAR QUE SU PRODUCTO NO SEA DAN ADO MIENTRAS ES ENSAMBLADO, SE RECOMIENDA LA ASISTENCIA DE UNA O MAUS PERSONAS.

**WARNING:** PROTECTIVE GLIDE IS PLACED UNDER EACH LEG OF THE FURNITURE TO RESIST SCRATCHES ON FLOOR SURFACE. SOME FLOOR SURFACES CAN BE EXTRA SENSITIVE TO SCRATCHES AND MARKINGS, IF YOU ARE NOT SURE CONSULT WITH YOUR DEALER. AVERTISSEMENT, LES PIEDS DES MEUBLES SONT MUNIS DE PATINS DESTINES A PROTEGER LE PLANCHER. CERTAINS REVETEMENTS DE SOL PEUVENT ETRE TRES FRAGILES. EN CAS DE DOUTE. CONSULTER LE MARCHAND.

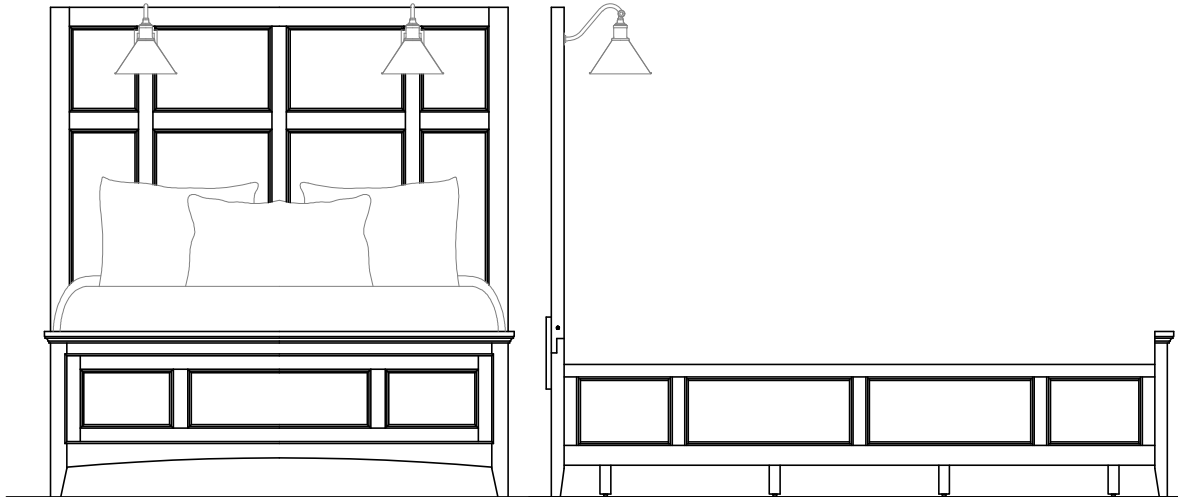











NOTE:  
ASSEMBLE UNIT ON A SOFT SURFACE.  
ASSEMBLEZ L'UNITÉ SUR UNE SURFACE MOLLE.  
ENSAMBLE LA UNIDAD EN UNA SUPERFICIE PLANA Y SUAVE.

DO NOT TIGHTEN BOLTS UNTIL **ALL PARTS AND HARDWARE OF** THE UNIT ARE ASSEMBLED.  
NE SERREZ PAS LES BOULONS JUSQU'À CE QUE L'UNITÉ SOIT COMPLÈTEMENT ASSEMBLÉE.  
NO APRIETE LOS TORNILLOS HASTA QUE LA UNIDAD ESTE COMPLETAMENTE ENSAMBLADA.













# ASSEMBLY INSTRUCTIONS INSTRUCTIONS DE MONTAGE INSTRUCCIONES DE MONTAJE

## QUEEN LIGHTED PANEL BED W/ STORAGE SIDE RAIL

### LIST OF PARTS AND HARDWARE/ LISTE DES PIÈCES ET DU MATÉRIEL/ LISTA DE PIEZAS Y HARDWARE

NO#/ NOMBRE/ NÚMERO	DESCRIPTION/ DESCRIPTION/ DESCRIPCIÓN		QUANTITY/ QUANTITÉ/ CANTIDAD
A	BOLT/ BOULON/ TORNILLO <span style="float: right;"><math>\frac{5}{16}</math>" DIAMETER x <math>4\frac{1}{2}</math>" LENGTH</span>		8 PCS
B	CURVED WASHER/RONDELLE COURBE/ ARANDELA CURVA <span style="float: right;"><math>\frac{5}{16}</math>" DIAMETER</span>		8 PCS
C	NUT/ÉCROU/NUEZ <span style="float: right;"><math>\frac{5}{16}</math>" DIAMETER</span>		8 PCS
D	WRENCH/ CLÉ/LLAVE INGLESА <span style="float: right;">1/2"</span>		1 PC
E	FLAT WASHER/ RONDELLE PLATE/ ARANDELA PLANA <span style="float: right;"><math>\frac{5}{16}</math>" DIAMETER x <math>\frac{3}{4}</math>" x <math>\frac{1}{16}</math>"</span>		12 PCS
F	LOCK WASHER/ RONDELLE DE BLOCAGE/ ARANDELA DE BLOQUEO <span style="float: right;"><math>\frac{5}{16}</math>" DIAMETER x <math>\frac{1}{2}</math>" x <math>\frac{1}{16}</math>"</span>		12 PCS
G	BOLT/ BOULON/ TORNILLO <span style="float: right;"><math>\frac{3}{16}</math>" DIAMETER x 2" LENGTH</span>		10 PCS
H	ALLEN KEY/ CLÉ ALLEN/LLAVE INGLESА ALLEN <span style="float: right;">3/16"</span>		1 PC
I	SCREW/VIS/TORNILLO <span style="float: right;">#4 x 1" LENGTH</span>		24 PCS
J	BOLT/ BOULON/ TORNILLO <span style="float: right;"><math>\frac{5}{16}</math>" DIAMETER x <math>1\frac{3}{16}</math>" LENGTH</span>		2 PCS

### LIST OF PARTS AND HARDWARE/ LISTE DES PIÈCES ET DU MATÉRIEL/ LISTA DE PIEZAS Y HARDWARE

NO#/ NOMBRE/ NÚMERO	DESCRIPTION/ DESCRIPTION/ DESCRIPCIÓN		QUANTITY/ QUANTITÉ/ CANTIDAD
1	HEADBOARD PANEL/PANNEAU DE TÊTE DE LIT/ PANEL DE CABECERO		1 PC
2	BOTTOM STRETCHER/ÉTIREUSE INFÉRIEURE/ CAMILLA INFERIOR		1 PC
3	LEFT HEADBOARD LEG/JAMBE DE TÊTE DE LIT GAUCHE/ PIERNA IZQUIERDA DEL CABECERO		1 PC
4	RIGHT HEADBOARD LEG/PIED DE TÊTE DE LIT DROIT/ PATAS DEL CABECERO DERECHO		1 PC
5	WOODEN MENDING PLATE/PLAQUE DE RÉPARATION EN BOIS/PLACA DE MADERA PARA MENDER		2 PCS
6	FOOTBOARD/ PIED DE LIT/ ESTRIBO		1 PC
7	SIDE RAIL/RAIL LATÉRAL/CARRIL LATERAL		2 PCS
8	SLAT ROLL (INCLUDED 12 PCS)/ROULEAU DE FENTE/ ROLLO DE RANURA		1 SET
9	BOTTOM SLAT/LAME INFÉRIEURE/LLANTA INFERIOR		2 PCS
10	SLAT SUPPORT LEG/JAMBE DE SUPPORT À LATTES/ PATAS DE SOPORTE DE LAMAS		4 PCS
11	BULB HOLDER/ PORTE-AMPOULE/ PORTALÁMPARAS		2 PCS
12	LAMP SHADE/ FORME DE LA LAMPE/ PANTALLA DE LÁMPARA		2 PCS
13	(OUTPUT: 12V-MAX:3W) LED LIGHT/LUMIÈRE LED/LUZ LED		2 PCS

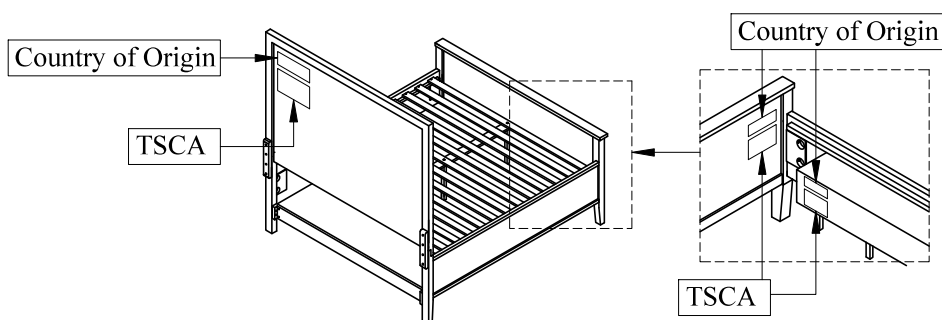

# ASSEMBLY INSTRUCTIONS INSTRUCTIONS DE MONTAGE INSTRUCCIONES DE MONTAJE

QUEEN LIGHTED PANEL BED W/ STORAGE SIDE RAIL

Note:  
Side rail      Mark      HB or FB

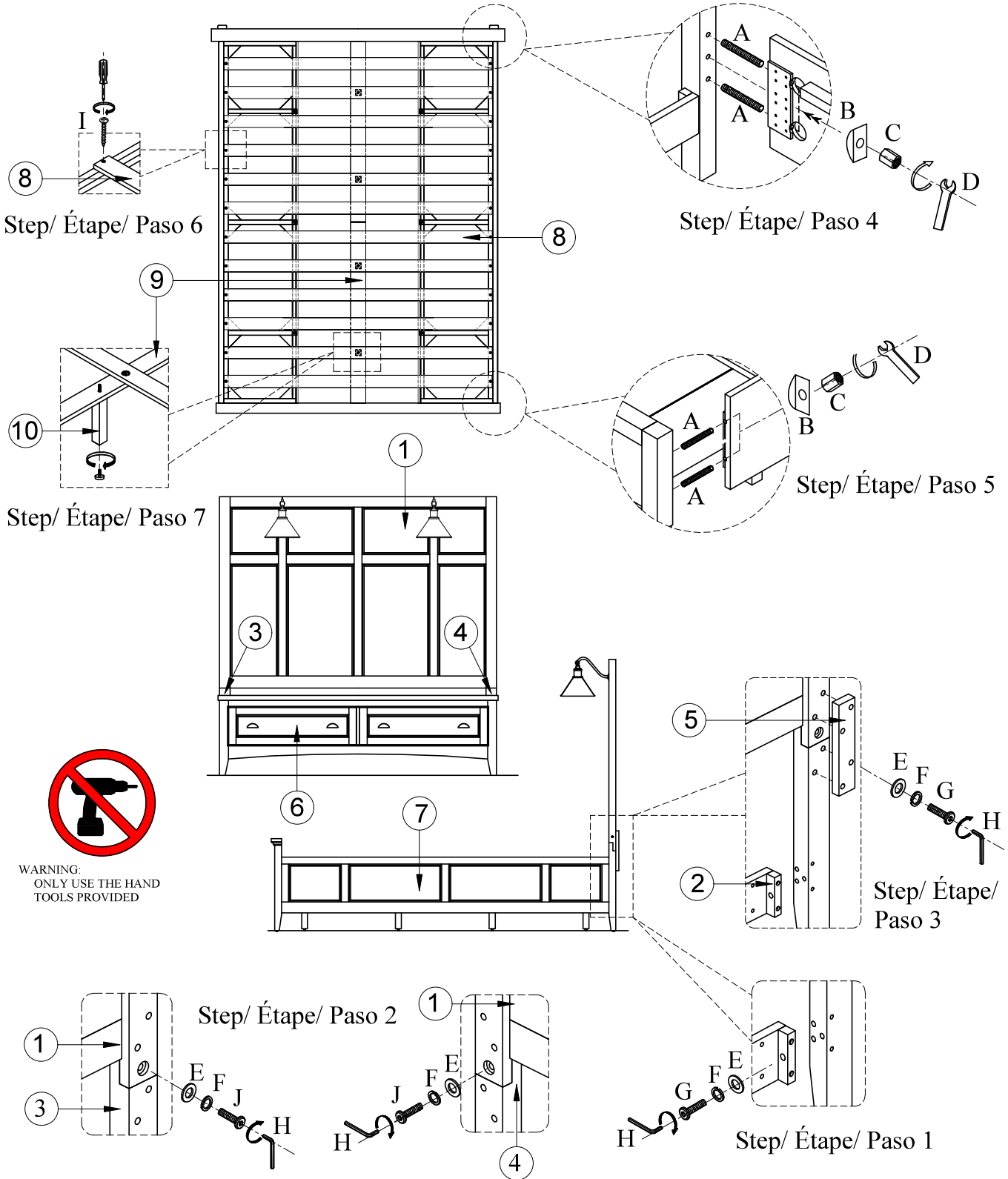

WARNING:  
ONLY USE THE HAND  
TOOLS PROVIDED

ASSEMBLY INSTRUCTIONS  
INSTRUCTIONS DE MONTAGE  
INSTRUCCIONES DE MONTAJE

QUEEN LIGHTED PANEL BED W/ STORAGE SIDE RAIL

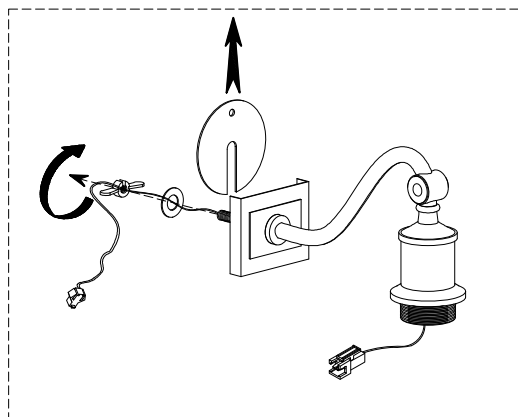

Step/ Étape/ Paso 8

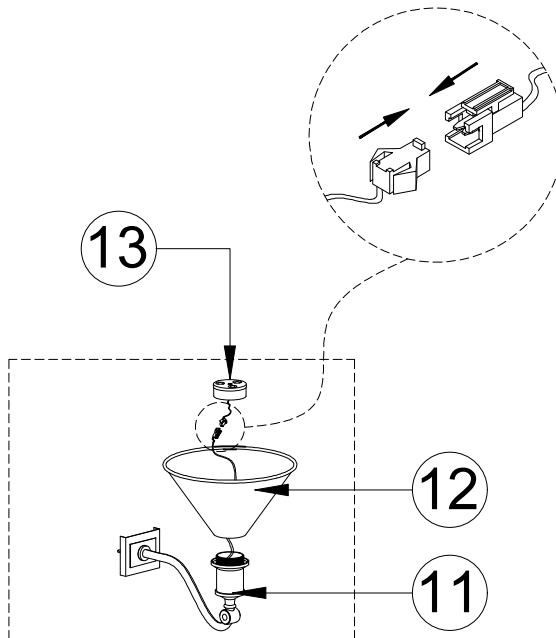

Step/ Étape/ Paso 9

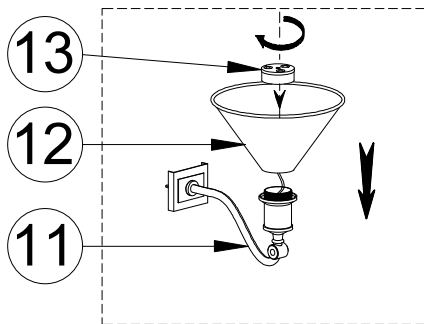

Step/ Étape/ Paso 10

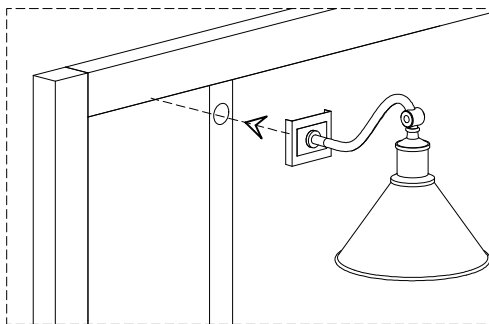

Step/ Étape/ Paso 11

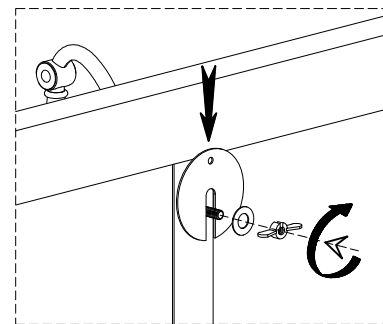

Step/ Étape/ Paso 12

**Note: Tighten the nut by hand only, until the fixture is secure, take care not to overtighten.**

# ASSEMBLY INSTRUCTIONS INSTRUCTIONS DE MONTAGE INSTRUCCIONES DE MONTAJE

QUEEN LIGHTED PANEL BED W/ STORAGE SIDE RAIL

## WIRING DIAGRAM

### Step/ Étape/ Paso 13

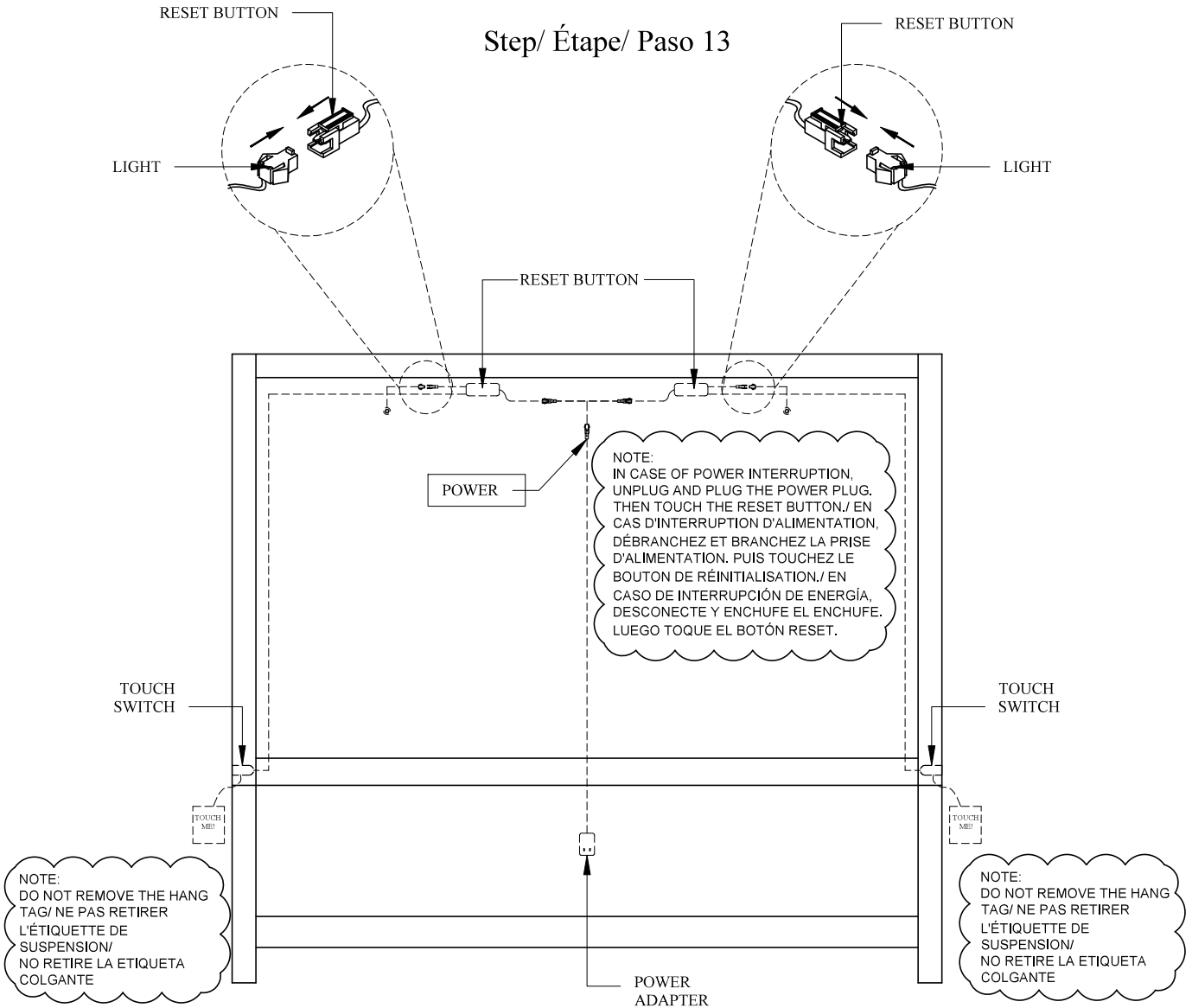

# ASSEMBLY INSTRUCTIONS INSTRUCTIONS DE MONTAGE INSTRUCCIONES DE MONTAJE

KING LIGHTED PANEL BED W/ STORAGE SIDE RAIL

**CAUTION:** PLEASE READ ALL INSTRUCTIONS BEFORE STARTING THE ASSEMBLY OF THIS PRODUCT. THESE PIECES ARE HEAVY. IN ORDER TO PREVENT PERSONAL INJURY AND ENSURE THAT THIS PRODUCT IS NOT DAMAGED DURING THE ASSEMBLY PROCESS, IT IS STRONGLY RECOMMENDED TO ENLIST THE ASSISTANCE OF ONE OR MORE PERSONS. IN CASE OF EXCESS STAIN, WIPE THE BOTTOM OF THE UNIT BEFORE PLACING ON ANY SURFACE.

**ATTENTION:** VEUILLEZ LIRE TOUTES LES INSTRUCTIONS AVANT DE COMMENCER L'ASSEMBLAGE DE CE PRODUIT. LES PIECES SONT LOURDES. POUR EVITER TOUTE BLESSURE ET POUR VOUS, ASSURER QUE LE PRODUIT N'EST PAS ENDOMMAGE' PENDANT L'ASSEMBLAGE, NOUS VOUS RECOMMANDONS DE FAIRE APPEL A UNE OU PLUSIEURS AUTRES PERSONNES. EN CAS DE TACHE EXCESSIVE, ESSUYEZ LE FOND DE L'UNITE' AVANT LE PLACEMENT SUR N'IMPORTE QUELLE SURFACE.

**CUIDADO:** FAVOR DE LEER TODAS LAS INSTRUCCIONES ANTES DE ENSAMBLAR SU PRODUCTO, ESTAS. PIEZAS SON PESADAS. PARA PREVENIR HERIDAS PERSONALES Y ASEGURAR QUE SU PRODUCTO NO SEA DAN ADO MIENTRAS ES ENSAMBLADO. SE RECOMIENDA LA ASISTENCIA DE UNA O MAUS PERSONAS.

**WARNING:** PROTECTIVE GLIDE IS PLACED UNDER EACH LEG OF THE FURNITURE TO RESIST SCRATCHES ON FLOOR SURFACE. SOME FLOOR SURFACES CAN BE EXTRA SENSITIVE TO SCRATCHES AND MARKINGS, IF YOU ARE NOT SURE CONSULT WITH YOUR DEALER.  
AVERTISSEMENT. LES PIEDS DES MEUBLES SONT MUNIS DE PATINS DESTINES A PROTEGER LE PLANCHER. CERTAINS REVETEMENTS DE SOL PEUVENT ETRE TRES FRAGILES. EN CAS DE DOUTE. CONSULTER LE MARCHAND.

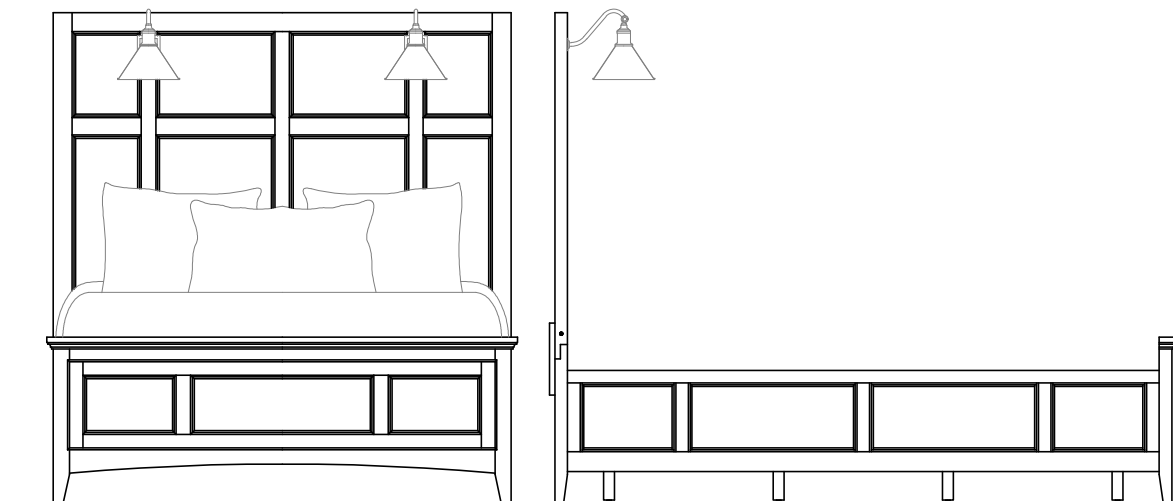











NOTE:  
ASSEMBLE UNIT ON A SOFT SURFACE.  
ASSEMBLEZ L'UNITÉ SUR UNE SURFACE MOLLE.  
ENSAMBLE LA UNIDAD EN UNA SUPERFICIE PLANA Y SUAVE.

DO NOT TIGHTEN BOLTS UNTIL **ALL PARTS AND HARDWARE OF** THE UNIT ARE ASSEMBLED.  
NE SERREZ PAS LES BOULONS JUSQU'À CE QUE L'UNITÉ SOIT COMPLÈTEMENT ASSEMBLÉE.  
NO APRIETE LOS TORNILLOS HASTA QUE LA UNIDAD ESTE COMPLETAMENTE ENSAMBLADA.













# ASSEMBLY INSTRUCTIONS INSTRUCTIONS DE MONTAGE INSTRUCCIONES DE MONTAJE

## KING LIGHTED PANEL BED W/ STORAGE SIDE RAIL

### LIST OF PARTS AND HARDWARE/ LISTE DES PIÈCES ET DU MATÉRIEL/ LISTA DE PIEZAS Y HARDWARE

NO#/ NOMBRE/ NÚMERO	DESCRIPTION/ DESCRIPTION/ DESCRIPCIÓN		QUANTITY/ QUANTITÉ/ CANTIDAD
A	BOLT/ BOULON/ TORNILLO $\frac{5}{16}$ " DIAMETER x $4\frac{1}{2}$ " LENGTH		8 PCS
B	CURVED WASHER/RONDELLE COURBE/ ARANDELA CURVA $\frac{5}{16}$ " DIAMETER		8 PCS
C	NUT/ÉCROU/NUEZ $\frac{5}{16}$ " DIAMETER		8 PCS
D	WRENCH/ CLÉ/LLAVE INGLESA 1/2"		1 PC
E	FLAT WASHER/ RONDELLE PLATE/ ARANDELA PLANA $\frac{5}{16}$ " DIAMETER x $\frac{3}{4}$ " x $\frac{1}{16}$ "		12 PCS
F	LOCK WASHER/ RONDELLE DE BLOCAGE/ ARANDELA DE BLOQUEO $\frac{5}{16}$ " DIAMETER x $\frac{1}{2}$ " x $\frac{1}{16}$ "		12 PCS
G	BOLT/ BOULON/ TORNILLO $\frac{5}{16}$ " DIAMETER x 2" LENGTH		10 PCS
H	ALLEN KEY/ CLÉ ALLEN/LLAVE INGLESA ALLEN 3/16"		1 PC
I	SCREW/VIS/TORNILLO #4 x 1" LENGTH		24 PCS
J	BOLT/ BOULON/ TORNILLO $\frac{5}{16}$ " DIAMETER x $1\frac{3}{16}$ " LENGTH		2 PCS

### LIST OF PARTS AND HARDWARE/ LISTE DES PIÈCES ET DU MATÉRIEL/ LISTA DE PIEZAS Y HARDWARE

NO#/ NOMBRE/ NÚMERO	DESCRIPTION/ DESCRIPTION/ DESCRIPCIÓN		QUANTITY/ QUANTITÉ/ CANTIDAD
1	HEADBOARD PANEL/PANNEAU DE TÊTE DE LIT/ PANEL DE CABECERO		1 PC
2	BOTTOM STRETCHER/ÉTIREUSE INFÉRIEURE/ CAMILLA INFERIOR		1 PC
3	LEFT HEADBOARD LEG/JAMBE DE TÊTE DE LIT GAUCHE/ PIERNA IZQUIERDA DEL CABECERO		1 PC
4	RIGHT HEADBOARD LEG/PIED DE TÊTE DE LIT DROIT/ PATAS DEL CABECERO DERECHO		1 PC
5	WOODEN MENDING PLATE/PLAQUE DE RÉPARATION EN BOIS/PLACA DE MADERA PARA MENDER		2 PCS
6	FOOTBOARD/ PIED DE LIT/ ESTRIBO		1 PC
7	SIDE RAIL/RAIL LATÉRAL/CARRIL LATERAL		2 PCS
8	SLAT ROLL (INCLUDED 12 PCS)/ROULEAU DE FENTE/ ROLLO DE RANURA		1 SET
9	BOTTOM SLAT/LAME INFÉRIEURE/LLANTA INFERIOR		2 PCS
10	SLAT SUPPORT LEG/JAMBE DE SUPPORT À LATTES/ PATAS DE SOPORTE DE LAMAS		4 PCS
11	BULB HOLDER/ PORTE-AMPOULE/ PORTALÁMPARAS		2 PCS
12	LAMP SHADE/ FORME DE LA LAMPE/ PANTALLA DE LÁMPARA		2 PCS
13	(OUTPUT: 12V-MAX:3W) LED LIGHT/LUMIÈRE LED/LUZ LED		2 PCS

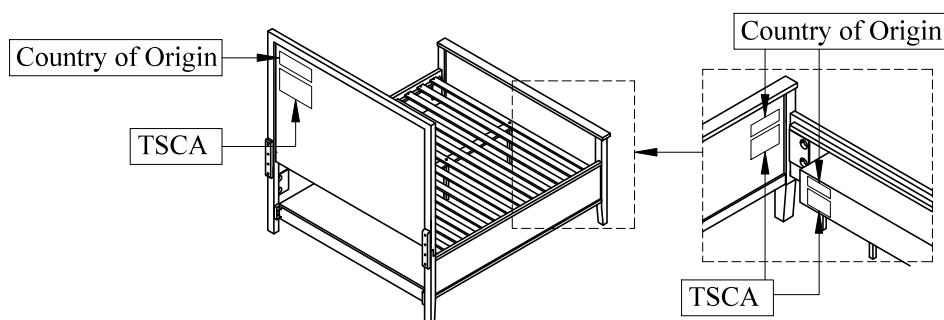

# ASSEMBLY INSTRUCTIONS INSTRUCTIONS DE MONTAGE INSTRUCCIONES DE MONTAJE

KING LIGHTED PANEL BED W/ STORAGE SIDE RAIL

Note:

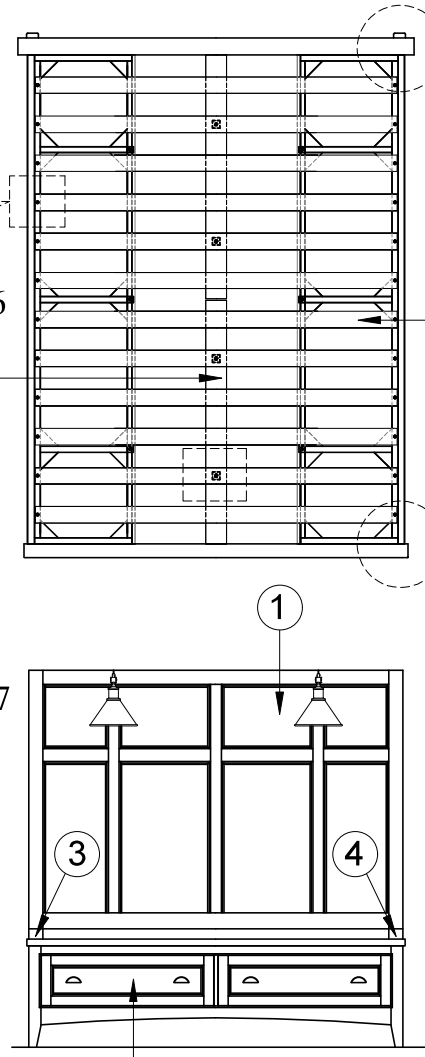
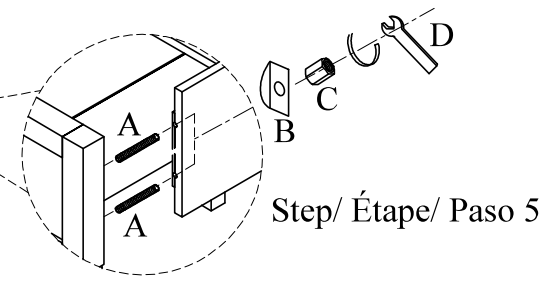
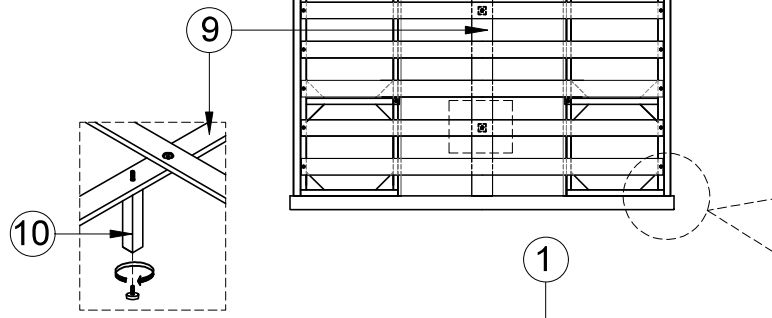
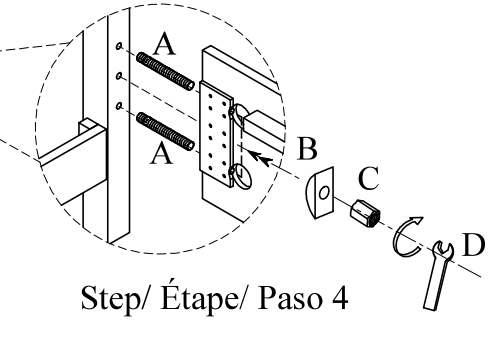
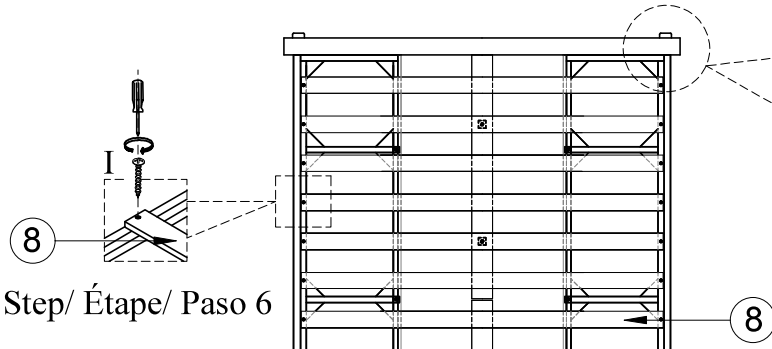
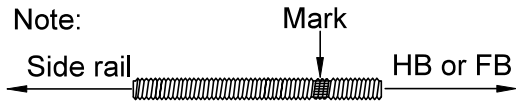

WARNING:  
ONLY USE THE HAND  
TOOLS PROVIDED

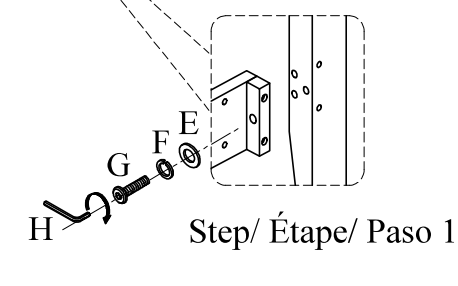
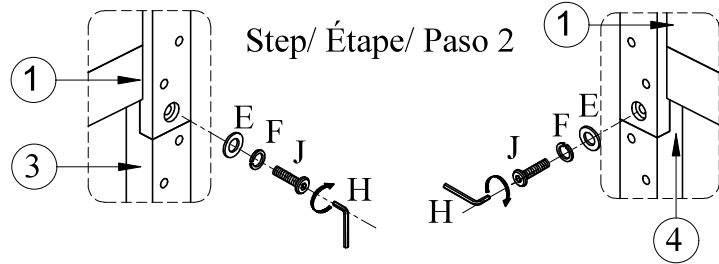
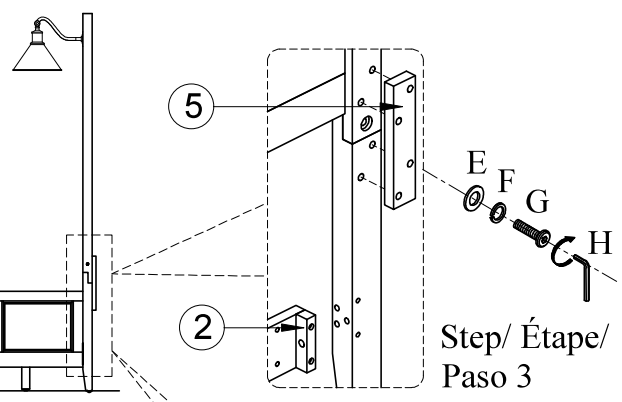

ASSEMBLY INSTRUCTIONS  
INSTRUCTIONS DE MONTAGE  
INSTRUCCIONES DE MONTAJE

KING LIGHTED PANEL BED W/ STORAGE SIDE RAIL

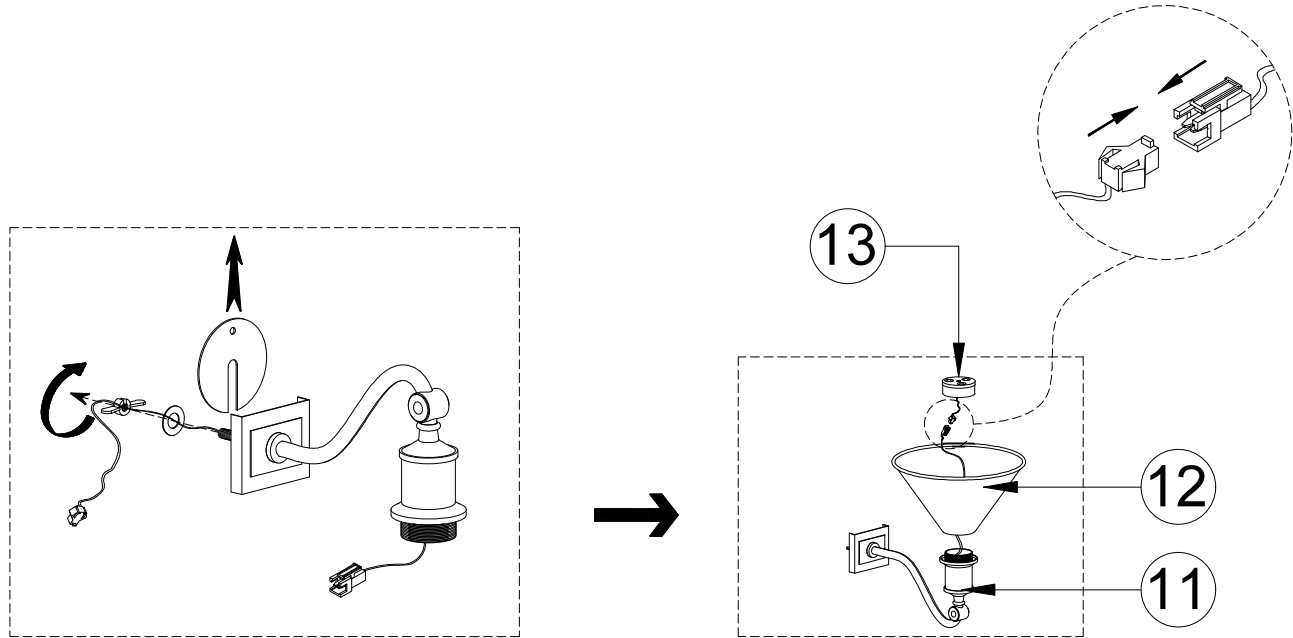

Step/ Étape/ Paso 8

Step/ Étape/ Paso 9

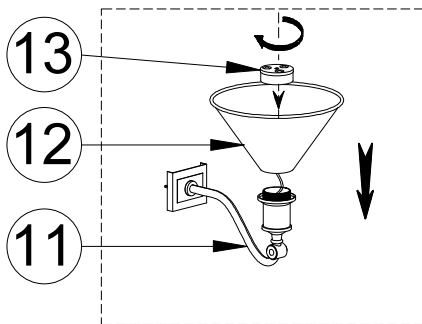

Step/ Étape/ Paso 10

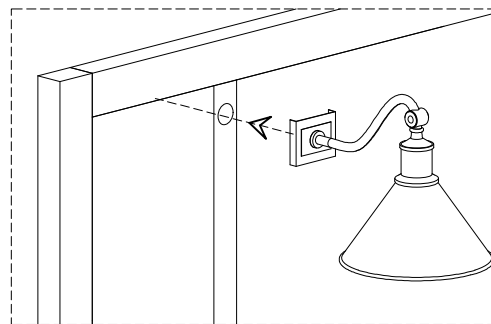

Step/ Étape/ Paso 11

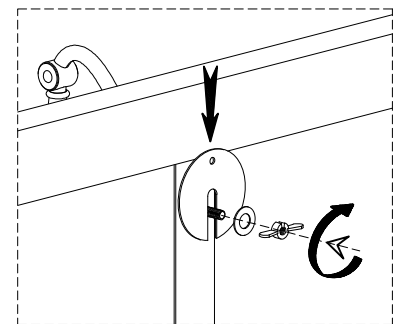

Step/ Étape/ Paso 12

**Note: Tighten the nut by hand only, until the fixture is secure, take care not to overtighten.**

# ASSEMBLY INSTRUCTIONS INSTRUCTIONS DE MONTAGE INSTRUCCIONES DE MONTAJE

KING LIGHTED PANEL BED W/ STORAGE SIDE RAIL

## WIRING DIAGRAM

### Step/ Étape/ Paso 13

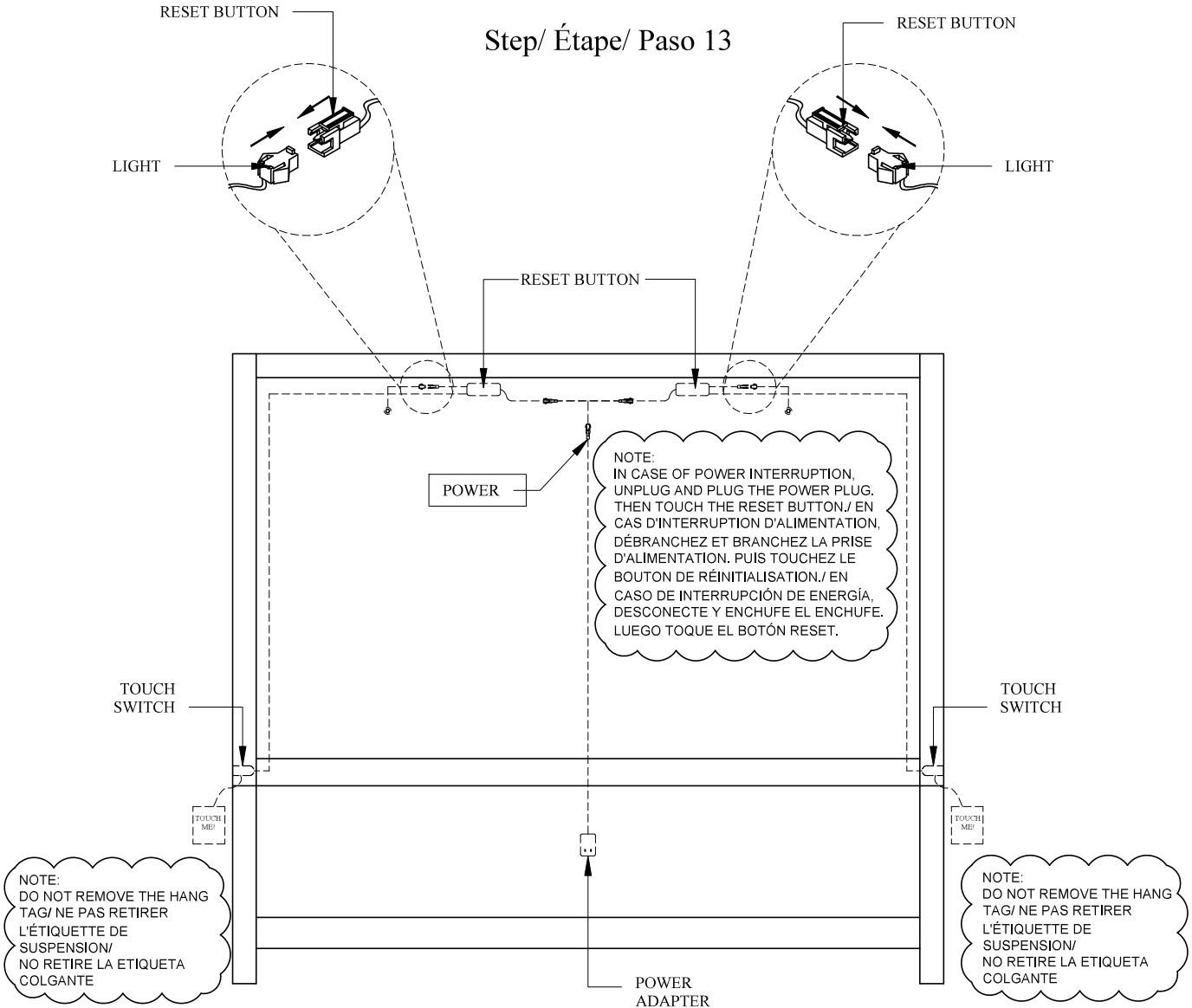

# ASSEMBLY INSTRUCTIONS INSTRUCTIONS DE MONTAGE INSTRUCCIONES DE MONTAJE

CAL. KING LIGHTED PANEL BED W/ STORAGE SIDE RAIL

**CAUTION:** PLEASE READ ALL INSTRUCTIONS BEFORE STARTING THE ASSEMBLY OF THIS PRODUCT. THESE PIECES ARE HEAVY. IN ORDER TO PREVENT PERSONAL INJURY AND ENSURE THAT THIS PRODUCT IS NOT DAMAGED DURING THE ASSEMBLY PROCESS, IT IS STRONGLY RECOMMENDED TO ENLIST THE ASSISTANCE OF ONE OR MORE PERSONS. IN CASE OF EXCESS STAIN, WIPE THE BOTTOM OF THE UNIT BEFORE PLACING ON ANY SURFACE.

**ATTENTION:** VEUILLEZ LIRE TOUTES LES INSTRUCTIONS AVANT DE COMMENCER L'ASSEMBLAGE DE CE PRODUIT. LES PIECES SONT LOURDES. POUR EVITER TOUTE BLESSURE ET POUR VOUS ASSURER QUE LE PRODUIT N'EST PAS ENDOMMAGE' PENDANT L'ASSEMBLAGE, NOUS VOUS RECOMMANDONS DE FAIRE APPEL A UNE OU PLUSIEURS AUTRES PERSONNES. EN CAS DE TACHE EXCESSIVE, ESSUYEZ LE FOND DE L'UNITE' AVANT LE PLACEMENT SUR N'IMPORTE QUELLE SURFACE.

**CUIDADO:** FAVOR DE LEER TODAS LAS INSTRUCCIONES ANTES DE ENSAMBLAR SU PRODUCTO, ESTAS. PIEZAS SON PESADAS. PARA PREVENIR HERIDAS PERSONALES Y ASEGURAR QUE SU PRODUCTO NO SEA DAN ADO MIENTRAS ES ENSAMBLADO. SE RECOMIENDA LA ASISTENCIA DE UNA O MAUS PERSONAS.

**WARNING:** PROTECTIVE GLIDE IS PLACED UNDER EACH LEG OF THE FURNITURE TO RESIST SCRATCHES ON FLOOR SURFACE. SOME FLOOR SURFACES CAN BE EXTRA SENSITIVE TO SCRATCHES AND MARKINGS, IF YOU ARE NOT SURE CONSULT WITH YOUR DEALER. AVERTISSEMENT. LES PIEDS DES MEUBLES SONT MUNIS DE PATINS DESTINES A PROTEGER LE PLANCHER. CERTAINS REVETEMENTS DE SOL PEUVENT ETRE TRES FRAGILES. EN CAS DE DOUTE. CONSULTER LE MARCHAND.

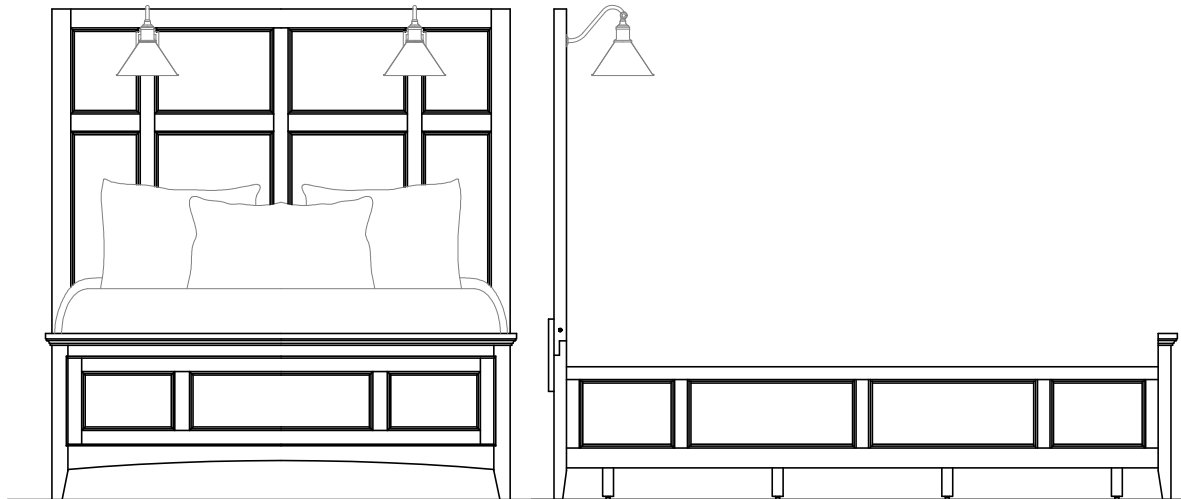











NOTE:  
ASSEMBLE UNIT ON A SOFT SURFACE.  
ASSEMBLEZ L'UNITE' SUR UNE SURFACE MOLLE.  
ENSAMBLE LA UNIDAD EN UNA SUPERFICIE PLANA Y SUAVE.

DO NOT TIGHTEN BOLTS UNTIL **ALL PARTS AND HARDWARE OF** THE UNIT ARE ASSEMBLED.  
NE SERREZ PAS LES BOULONS JUSQU'À CE QUE L'UNITE' SOIT COMPLÈTEMENT ASSEMBLÉE.  
NO APRIETE LOS TORNILLOS HASTA QUE LA UNIDAD ESTE COMPLETAMENTE ENSAMBLADA.















# ASSEMBLY INSTRUCTIONS INSTRUCTIONS DE MONTAGE INSTRUCCIONES DE MONTAJE

CAL. KING LIGHTED PANEL BED W/ STORAGE SIDE RAIL

## LIST OF PARTS AND HARDWARE/ LISTE DES PIÈCES ET DU MATÉRIEL/ LISTA DE PIEZAS Y HARDWARE

NO#/ NOMBRE/ NÚMERO	DESCRIPTION/ DESCRIPTION/ DESCRIPCIÓN		QUANTITY/ QUANTITÉ/ CANTIDAD
A	BOLT/ BOULON/ TORNILLO $\frac{5}{16}$ " DIAMETER x 4 $\frac{1}{2}$ " LENGTH		8 PCS
B	CURVED WASHER/RONDELLE COURBE/ ARANDELA CURVA $\frac{5}{16}$ " DIAMETER		8 PCS
C	NUT/ÉCROU/NUEZ $\frac{5}{16}$ " DIAMETER		8 PCS
D	WRENCH/ CLÉ/LLAVE INGLESA 1/2"		1 PC
E	FLAT WASHER/ RONDELLE PLATE/ ARANDELA PLANA $\frac{5}{16}$ " DIAMETER x $\frac{3}{4}$ " x $\frac{1}{16}$ "		20 PCS
F	LOCK WASHER/ RONDELLE DE BLOCAGE/ ARANDELA DE BLOQUEO $\frac{5}{16}$ " DIAMETER x $\frac{3}{4}$ " x $\frac{1}{16}$ "		20 PCS
G	BOLT/ BOULON/ TORNILLO $\frac{5}{16}$ " DIAMETER x 2" LENGTH		10 PCS
H	ALLEN KEY/ CLÉ ALLEN/LLAVE INGLESA ALLEN 3/16"		1 PC
I	SCREW/VIS/TORNILLO #4 x 1" LENGTH		24 PCS
J	BOLT/ BOULON/ TORNILLO $\frac{5}{16}$ " DIAMETER x 1 $\frac{3}{16}$ " LENGTH		2 PCS
K	BOLT/ BOULON/ TORNILLO $\frac{5}{16}$ " DIAMETER x 2 $\frac{1}{2}$ " LENGTH		8 PCS

## LIST OF PARTS AND HARDWARE/ LISTE DES PIÈCES ET DU MATÉRIEL/ LISTA DE PIEZAS Y HARDWARE

NO#/ NOMBRE/ NÚMERO	DESCRIPTION/ DESCRIPTION/ DESCRIPCIÓN		QUANTITY/ QUANTITÉ/ CANTIDAD
1	HEADBOARD PANEL/PANNEAU DE TÊTE DE LIT/ PANEL DE CABECERO		1 PC
2	BOTTOM STRETCHER/ÉTIREUSE INFÉRIEURE/ CAMILLA INFERIOR		1 PC
3	LEFT HEADBOARD LEG/JAMBE DE TÊTE DE LIT GAUCHE/ PIERNA IZQUIERDA DEL CABECERO		1 PC
4	RIGHT HEADBOARD LEG/PIED DE TÊTE DE LIT DROIT/ PATAS DEL CABECERO DERECHO		1 PC
5	WOODEN MENDING PLATE/PLAQUE DE RÉPARATION EN BOIS/PLACA DE MADERA PARA MENDER		2 PCS
6	FOOTBOARD/ PIED DE LIT/ ESTRIBO		1 PC
7	SIDE RAIL/RAIL LATÉRAL/CARRIL LATERAL		2 PCS
8	SIDE RAIL CLEATS/RAILS LATÉRAUX/ TAPAS DE RIEL LATERAL		2 PCS
9	SLAT ROLL (INCLUDED 12 PCS)/ROULEAU DE FENTE/ ROLLO DE RANURA		1 SET
10	BOTTOM SLAT/LAME INFÉRIEURE/LLANTA INFERIOR		2 PCS
11	SLAT SUPPORT LEG/JAMBE DE SUPPORT À LATTES/ PATAS DE SOPORTE DE LAMAS		4 PCS
12	BULB HOLDER/ PORTE-AMPOULE/ PORTALÁMPARAS		2 PCS
13	LAMP SHADE/ FORME DE LA LAMPE/ PANTALLA DE LÁMPARA		2 PCS
14	(OUTPUT: 12V-MAX:3W) LED LIGHT/LUMIÈRE LED/LUZ LED		2 PCS

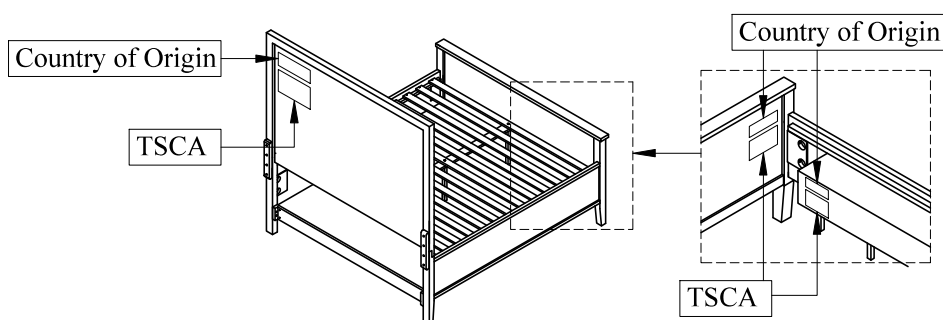

# ASSEMBLY INSTRUCTIONS INSTRUCTIONS DE MONTAGE INSTRUCCIONES DE MONTAJE

CAL. KING LIGHTED PANEL BED W/ STORAGE SIDE RAIL

Note:  
Side rail      Mark      HB or FB

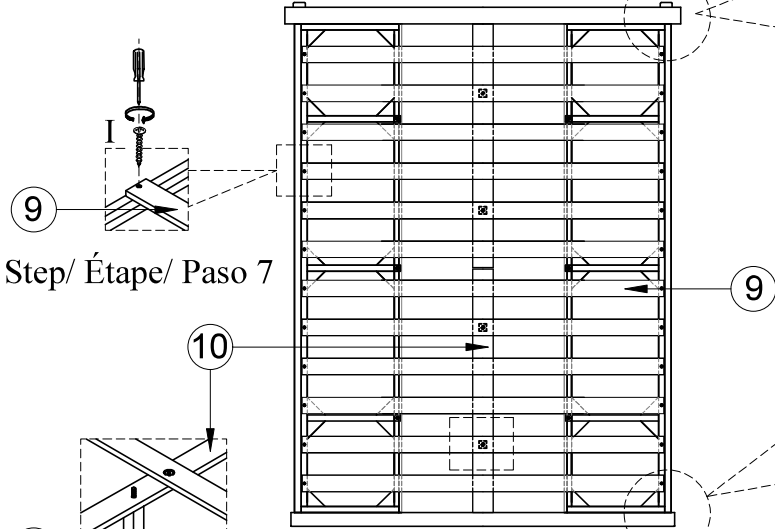

Step/ Étape/ Paso 7

Step/ Étape/ Paso 8

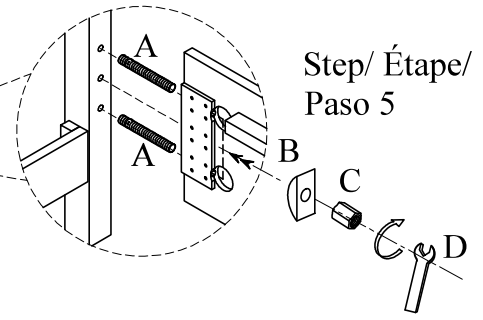

Step/ Étape/ Paso 5

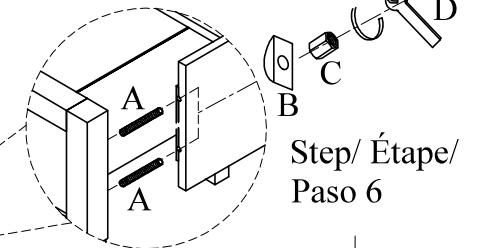

Step/ Étape/ Paso 6

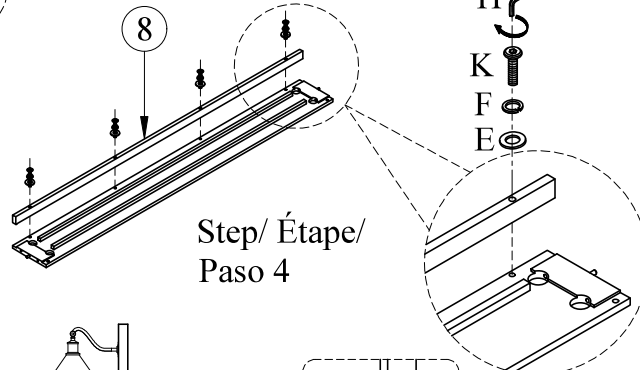

Step/ Étape/ Paso 4



WARNING:  
ONLY USE THE HAND  
TOOLS PROVIDED

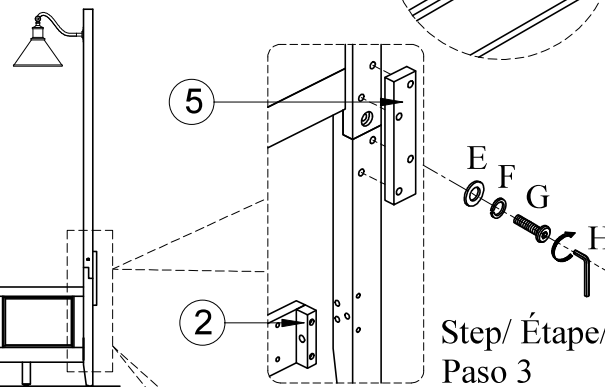
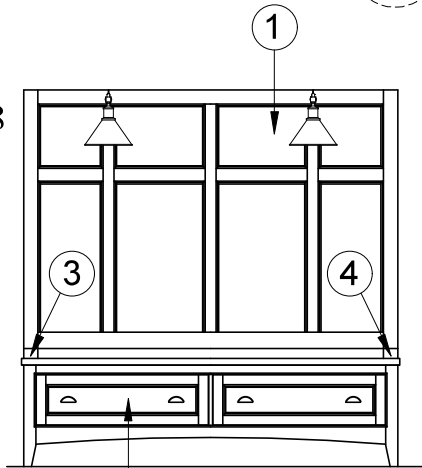

Step/ Étape/ Paso 3

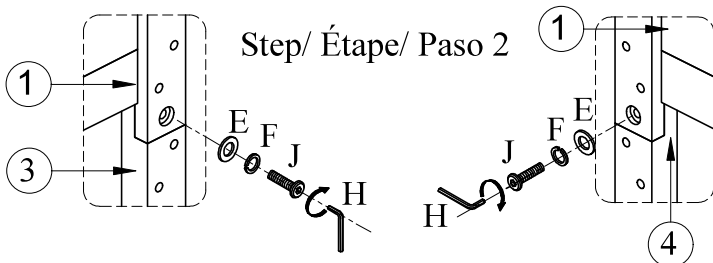

Step/ Étape/ Paso 2

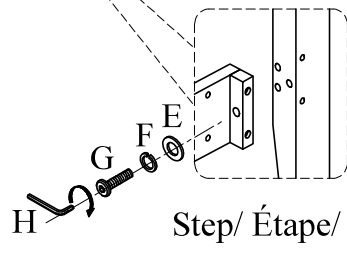

Step/ Étape/ Paso 1

ASSEMBLY INSTRUCTIONS  
INSTRUCTIONS DE MONTAGE  
INSTRUCCIONES DE MONTAJE

CAL. KING LIGHTED PANEL BED W/ STORAGE SIDE RAIL

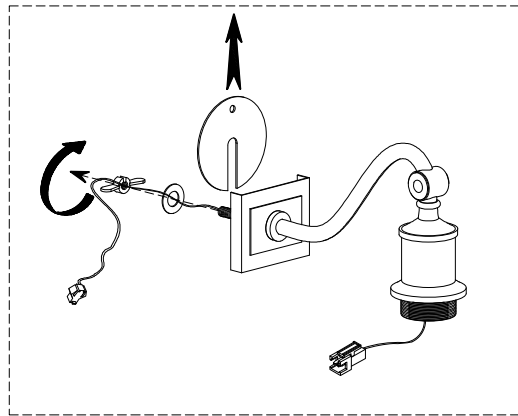

Step/ Étape/ Paso 9

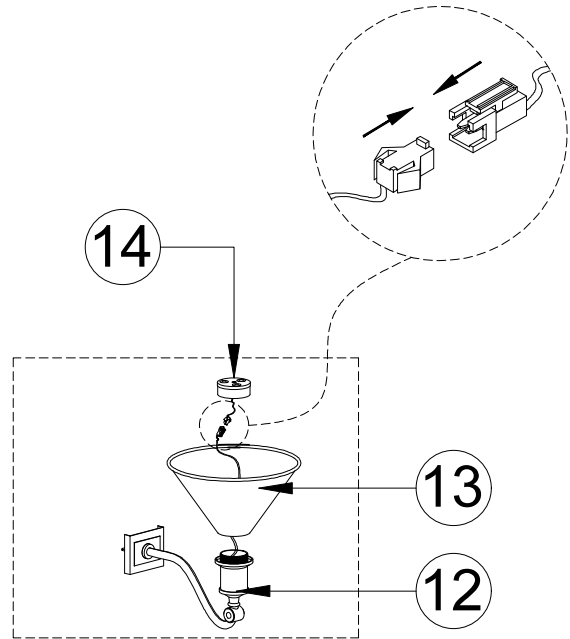

Step/ Étape/ Paso 10

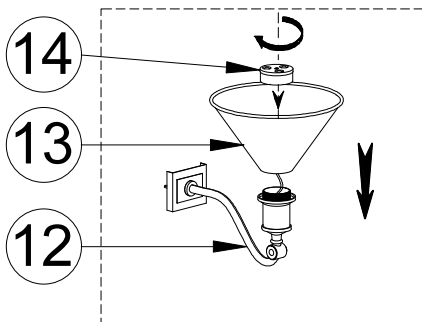

Step/ Étape/ Paso 11

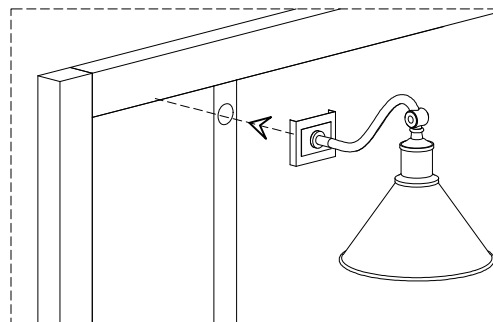

Step/ Étape/ Paso 12

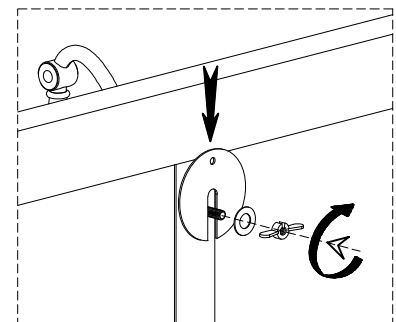

Step/ Étape/ Paso 13

**Note: Tighten the nut by hand only, until the fixture is secure, take care not to overtighten.**

# ASSEMBLY INSTRUCTIONS INSTRUCTIONS DE MONTAGE INSTRUCCIONES DE MONTAJE

CAL. KING LIGHTED PANEL BED W/ STORAGE SIDE RAIL

## WIRING DIAGRAM

