

Recliner Sofa

Operating instruction

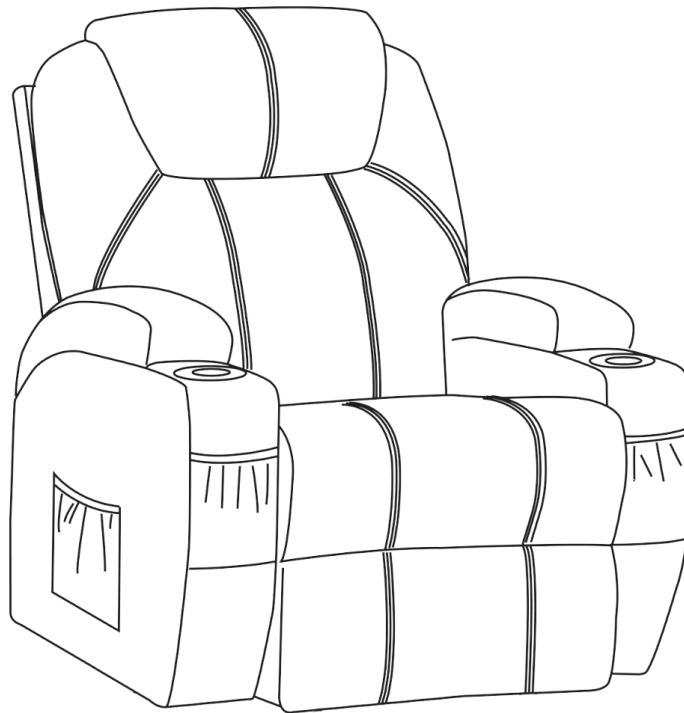

NOTE 1: This sofa is shipped in 2 box . All accessories included. If you have any questions after receiving the recliner. Please contact us in time and provide pictures. We will try our best to help you solve it.

NOTE 2: Please do not rotate 360 degrees when plugged in!

WARRANTY

So glad you have completed the assembly and can enjoy it. If you are satisfied with our products, thank you for showing your favored recliner to your around.

The quality of our furnitures has been strictly controlled. Each stage of the product upgrading has condensed the efforts of employees in various departments. We strive to minimize the probability of failure of new products and insist on providing customers with worthless after-sales service.

AFTER-SALE POLICY

For return reason:

Wrong purchase, bought by mistake, no longer needed, doesn't meet expectation, a size smaller than expectation, customer need to cover the return shipping fee.

For cancel order:

Customer needs to pay for shipping fee and carrier handle fee if the item has been shipped out.

For change address:

Customer needs to pay for extra shipping fee and carrier handle fee if the item has been shipped out.

Customer Service: Any problem with the product or shipping issue, please feel free to contact us, we will try our best to serve and help.



ATTENTION

Enjoyable time on recliner is coming after 15 minutes of installation!

- 1. Please check the manual carefully and make sure you have received all the parts.**
- 2. If there is any missing parts, please let us know the letter of the parts you need.**
- 3. If there is any damage parts, please send clear photos to us, we will check and offer you best solution soon.**

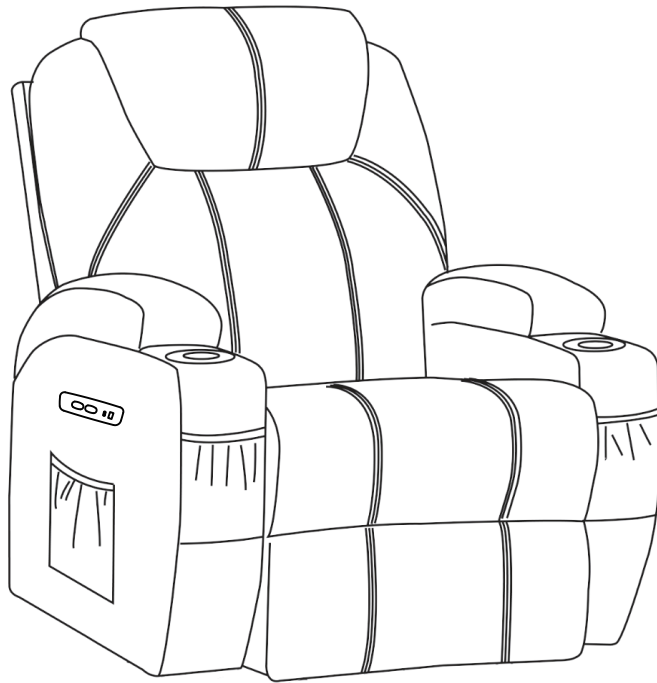
Please check if the accessories parts are completely received according to the letter labels and quantity below

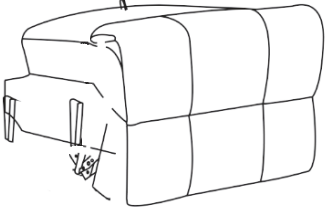
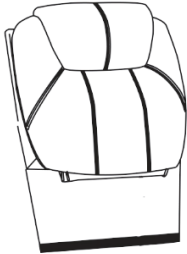
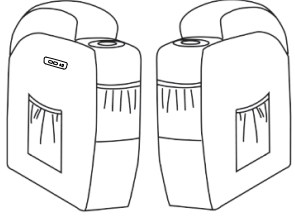

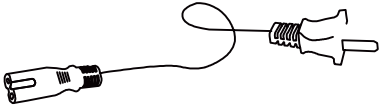
Parts List		
A X1	B X1	C X2
		
Chair base	Backrest	Left and right armrest
H X1	I X1	
		
Power Source	Power Source	

Step 1. Untie The Strap

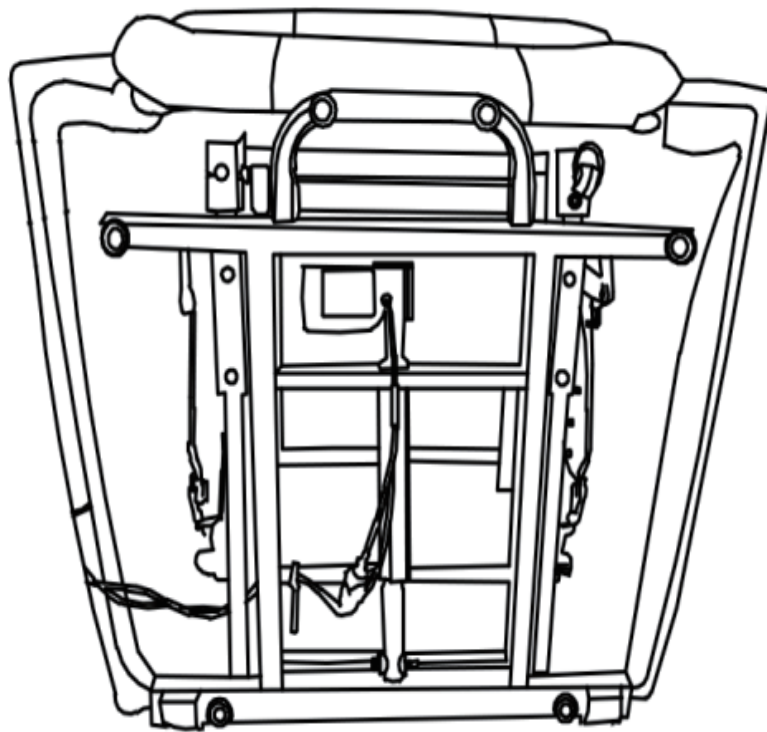

Please untie the strap on the rack to start assembly process.

Step 2. Attached The Chair Arm

Footrest and handle

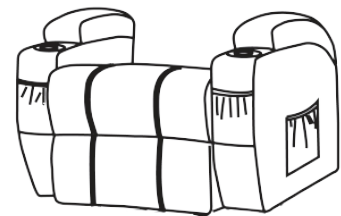
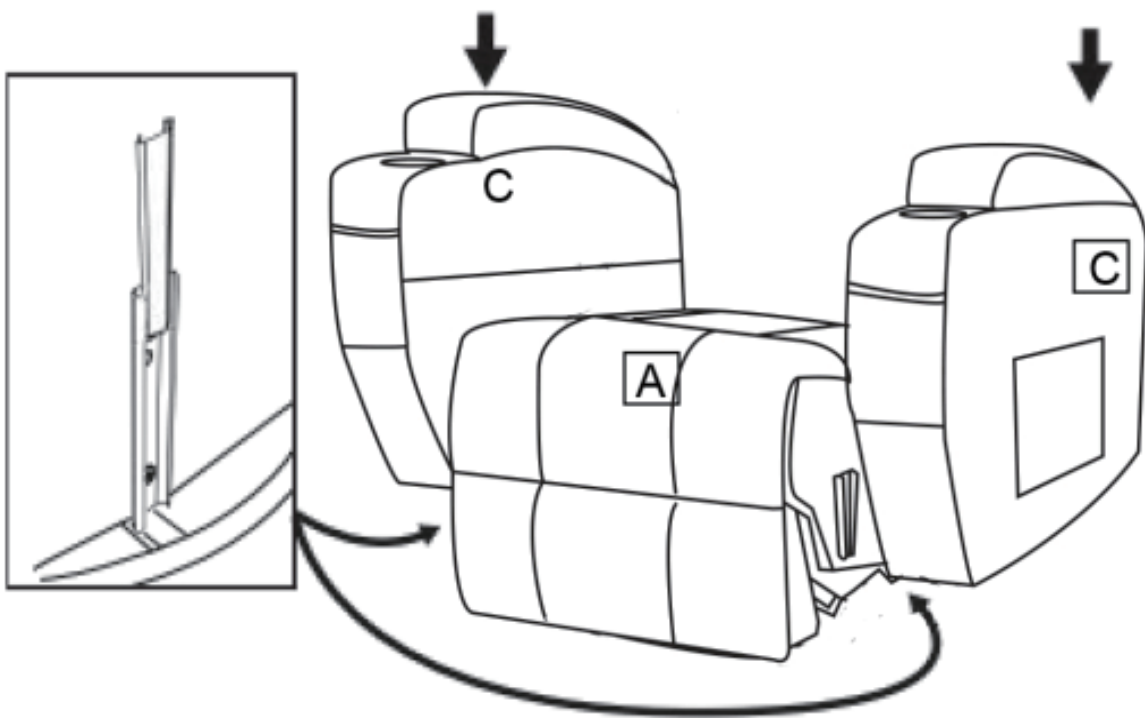

Step 3. Assemble The Backrest

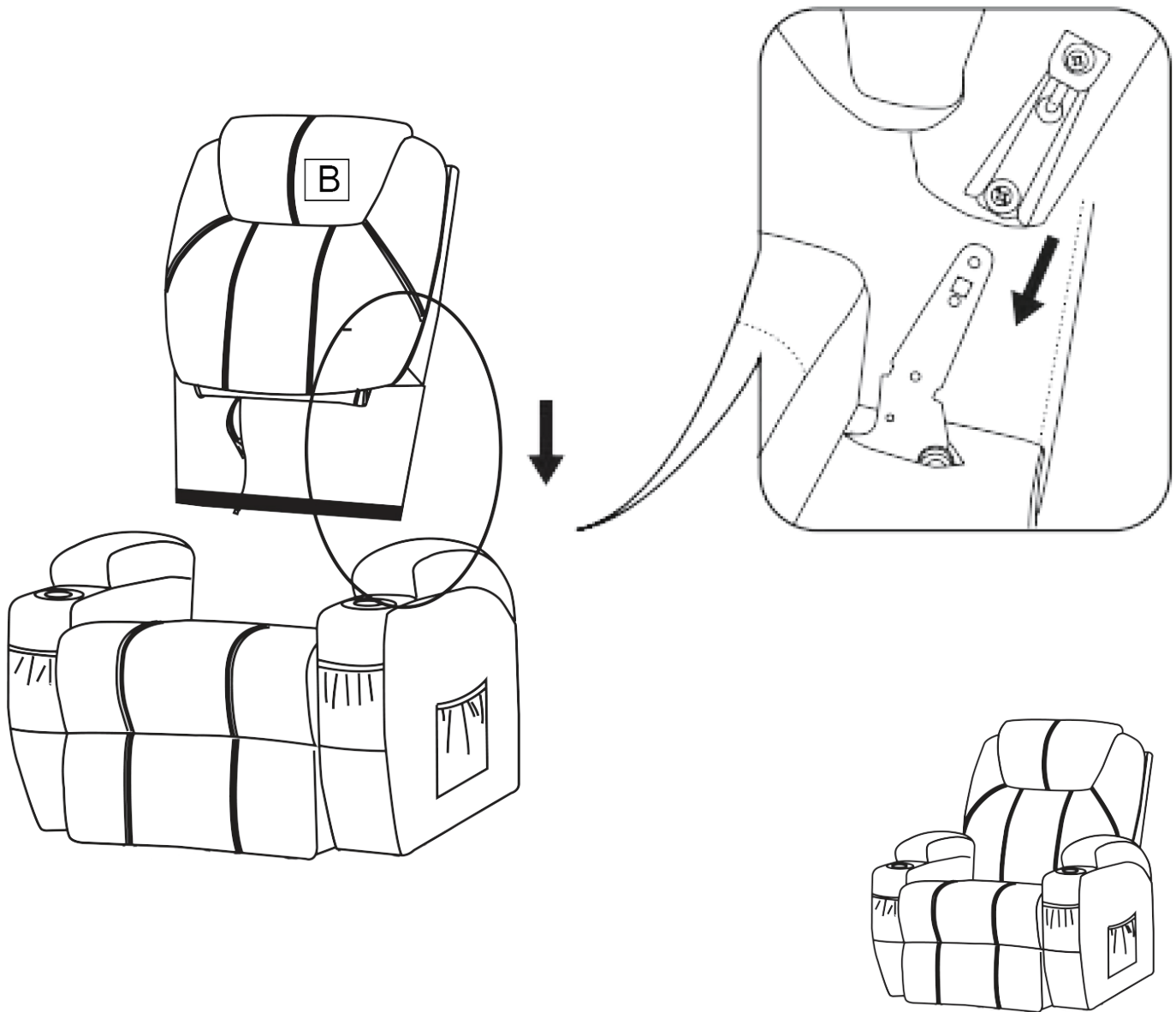

Step 4. Connect All Wires

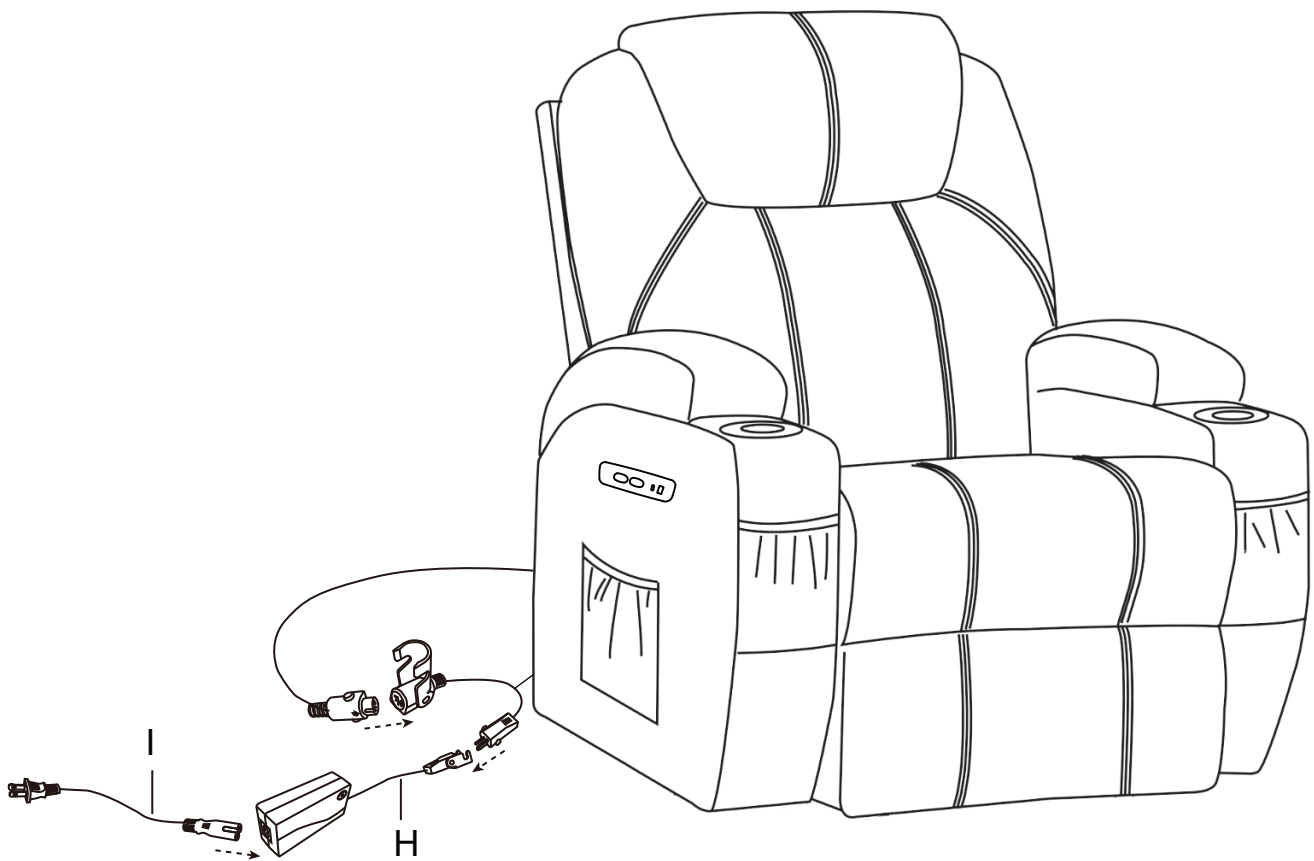

How to recline?

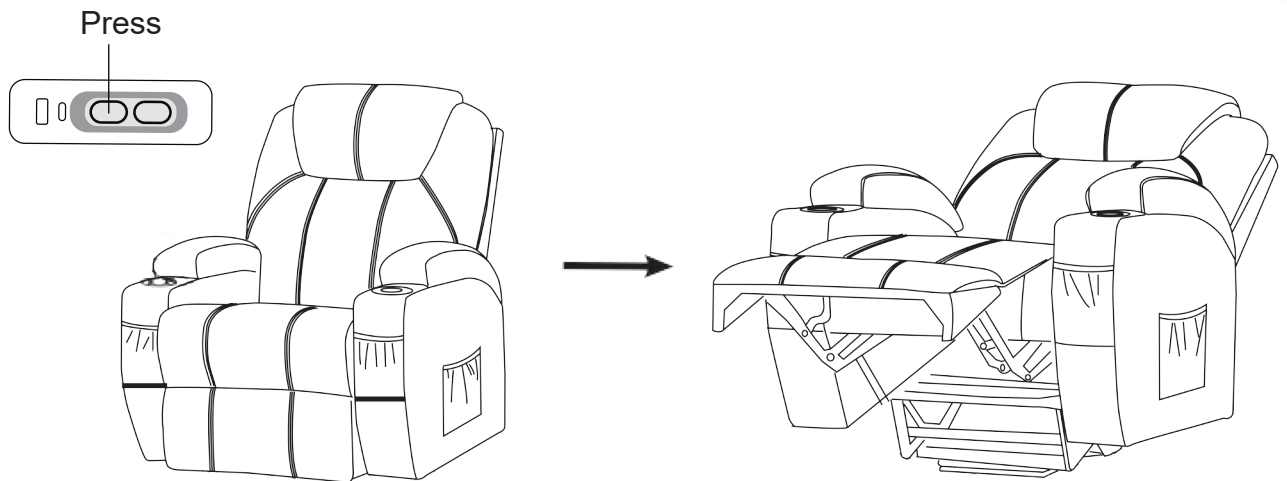

How to get footrest latch down?

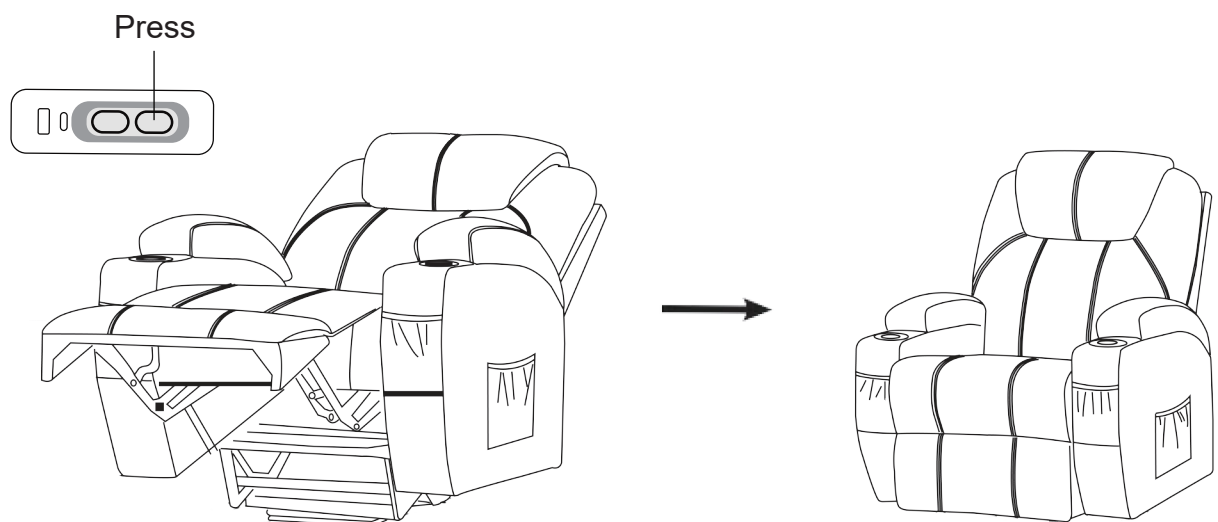

How to remove the chair ?

Please note that you need to take apart the backrest before removing the arms.

1. Force apart the buckles while take the backrest out from the arms.

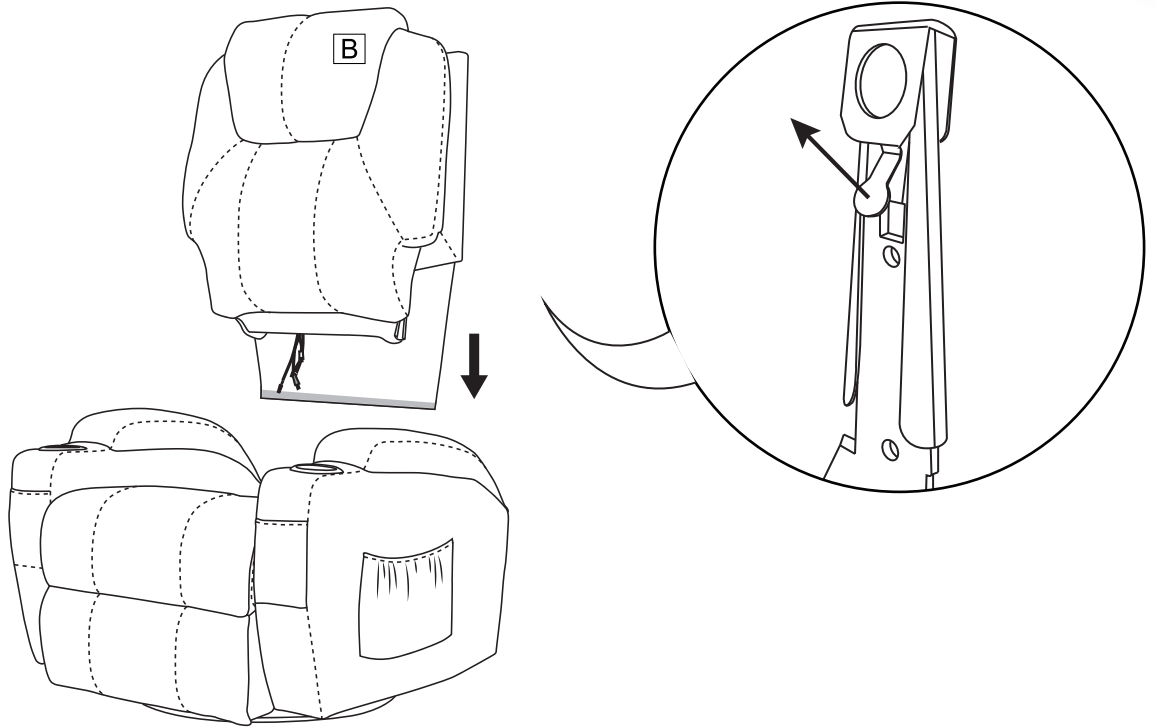

2. Then pull out the arms from the base.

Note: Please pull out the armrests from the middle of the armrests.

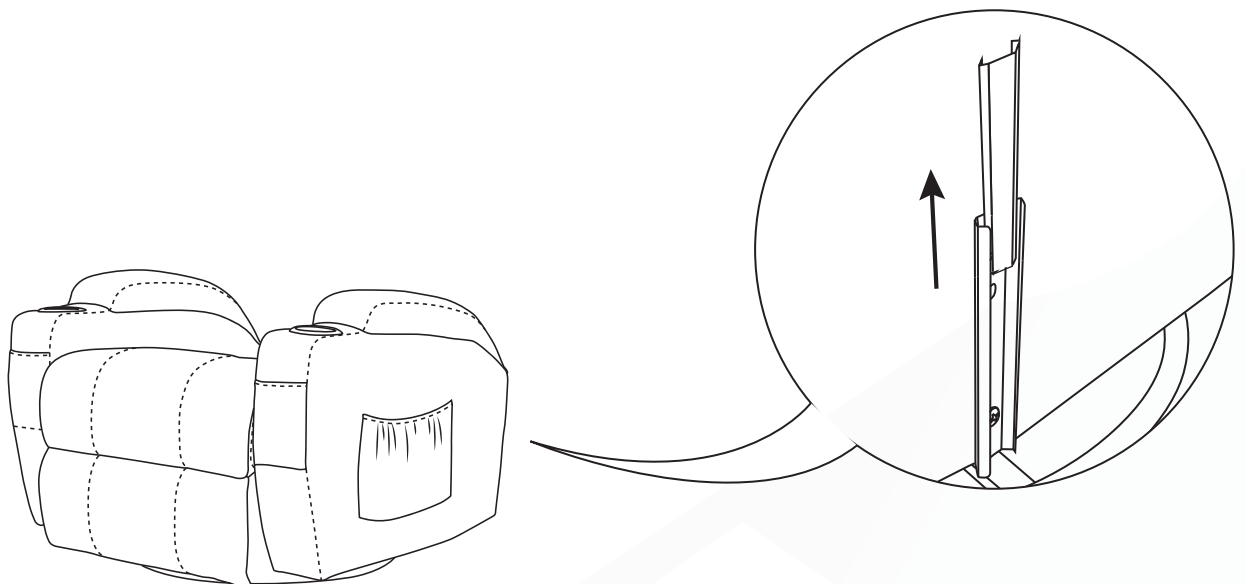

Warning

2-Person lift

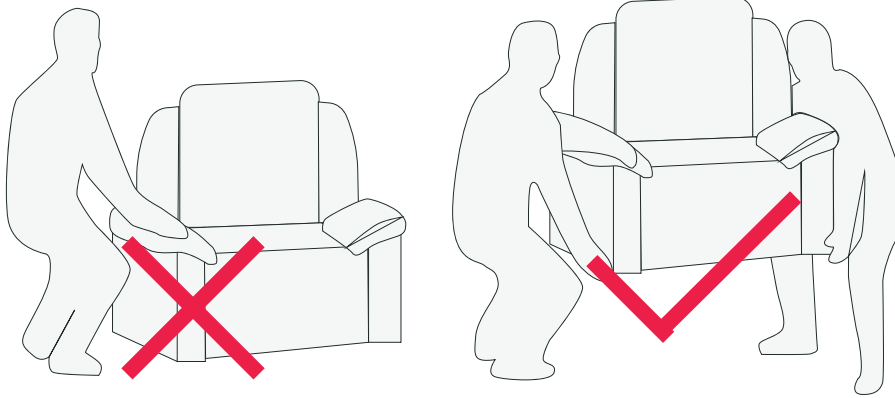

Do not move chair when it's reclining

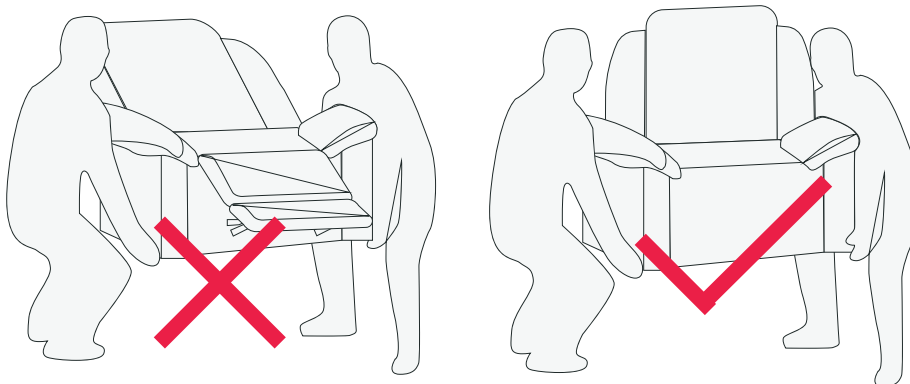

Unplug all power source from socket, then unplug all wires connection before move chair

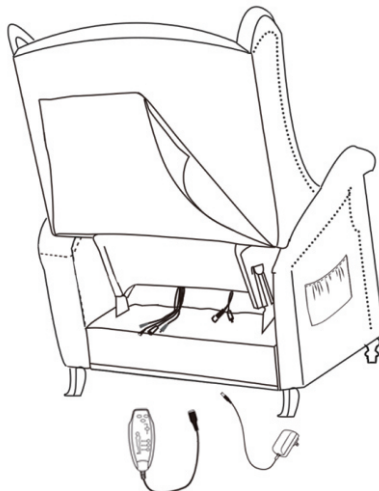

Warning

Do not sit/kick/stand on the footrest when the chair is on reclining position

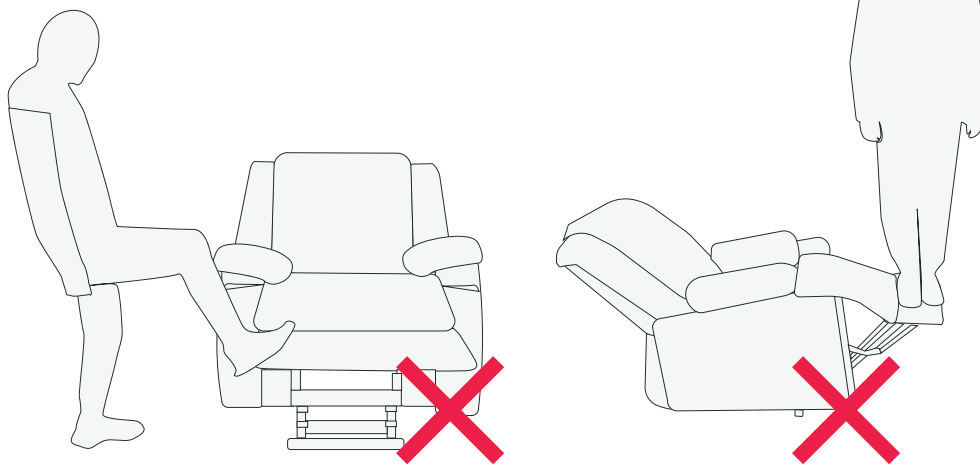

Do not stand up when the chair is on reclining position

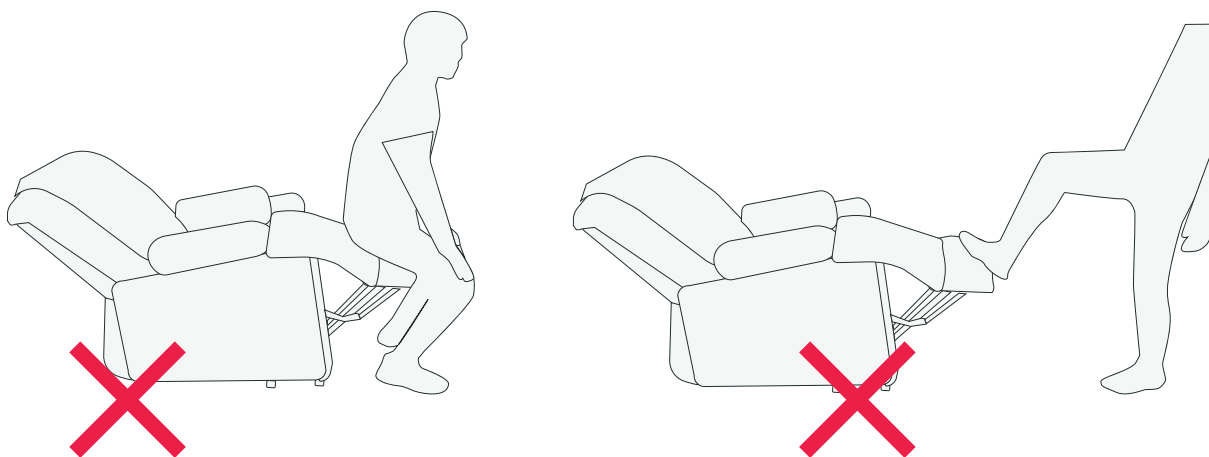

Leave enough space between chair back and wall before reclining

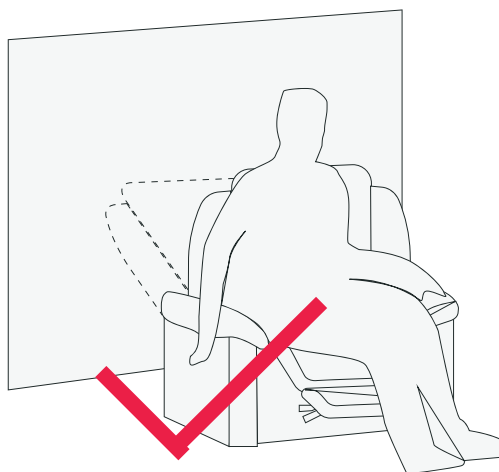
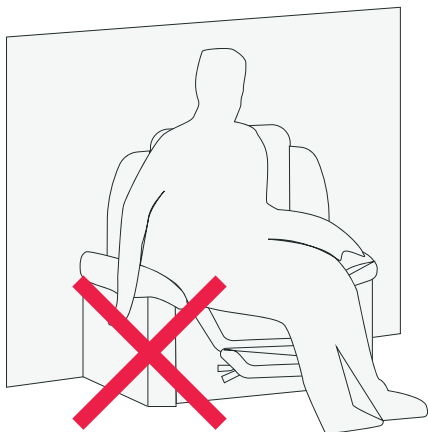

Do not sit on or press armrest

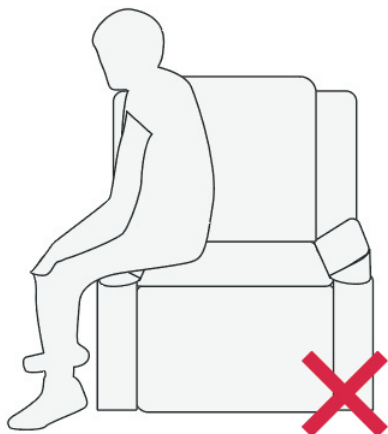

Do not press armrest after recline



Do not smoke or play with fire