

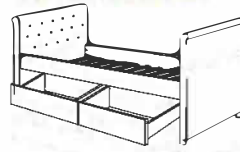









# ASSEMBLY INSTRUCTION













## Part list

No.	Parts	Description	TY
A		Headboard	1
B		Footboard	1
E		Bed Slats	1
H		Side panel of Drawer box	4
K		Bottom panel of Drawer box	2
J		Foot	4

C		Bed Rail	2
F		Upholstered Front panel of Drawer box	2
G		Back panel of Drawer box	2
M		Stop Rail behind the Drawer box	1

## Part list

No.	Parts	Description	TY
1		Hang Bolt	8
2		Crescent Spacer	8
3		Nut 5/16"	8
4		Wrench	1
5		Allen Wrench (1/4")	1
6		Wheel	8
7		Bolt 1/4"x1"	18
8		Wood Screw #8x1"	24
9		Wood Screw #8x5/8"	32
10		L metal bracket	2

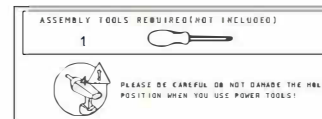

- STEP 1:**
1. Screw four feet into the bottom of Headboard and footboard, as show in Figure 1
  2. Screw Hang Bolts (1) into Headboard (A).Make sure there is enough length of the Hang Bolts (1) for next step as show in Figure 2.
  3. Insert Hang Bolts (1) through the hole of Bed Rails (C) as shown in Figure 3.
  4. Attach Bed Rail (C) to Headboard (A) using Crescent Spacer (2), and Nut (3). tighten with Wrench(4) as show in Figure 4. Don't tight Nut (3) fully.
  5. Repeat the steps 1,2,& 3 for Footboard (2).
  6. When Headboard (A), Footboard (B) and Bolt Rails (C) fixed, please fully tighten all Nuts (3).

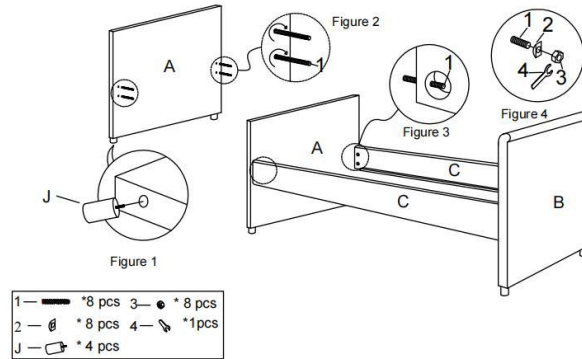

- STEP 2:**
1. Put 10 pieces of Bed Slats (E) on the Bed Rails (C).
  2. Install Slat Pack with slats starting and ending flush with the end of the support cleat attached to your bed rails **Figure 1**.
  3. Using Screw driver to tighten 20 Pieces of Wood Screws (8) clockwise as shown.
  4. Attach the L metal bracket(10) to stop rail (M) using Screw (8). As shown Figure 2.
  5. Attach the stop rail(M) to both Headboard and Footboard using Bolt (7) and Tighten with Allen Wrench (5). As shown in Figure 3.

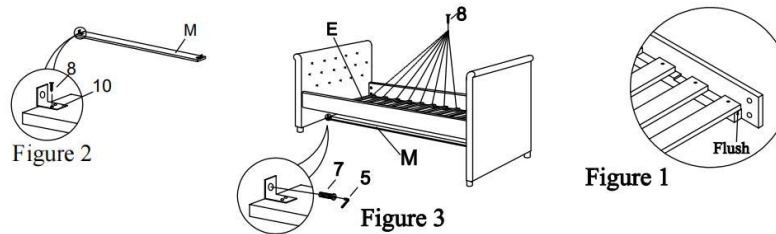

- |      |           |
|------|-----------|
| 7 —  | ⤴ *2 pcs  |
| 8 —  | ⤴ *24 pcs |
| 10 — | ⤴ *2 pcs  |

- STEP 3: 1. Insert bottom panel (K) to slot in one side panel (H) and both back panel (G) and Upholstered Front panel (F). As shown Figure 1.
2. Attach side panel to both front and back panel using bolt (7), tighten with Allen Wrench (5), as shown Figure 2.
3. Attach another side panel (H) to bottom panel (K) and both Upholstered front panel (F) and back panel (G), tighten with Allen Wrench (5) as shown Figure 3.

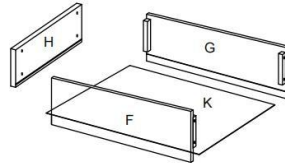

Figure 1

- 5 —  \*1 pc
- 7 —  \*16 pcs

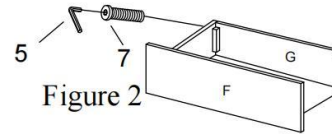

Figure 2

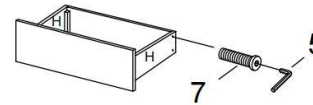

Figure 3

- STEP 4: 1. Attach 8 pieces of Wheels (6) to the back side of both drawer boxes with 16 pieces of Wood Screws (9), as shown in figure 1. and attach 1 pc of L shape bracket with 2 pieces of Wood screws.

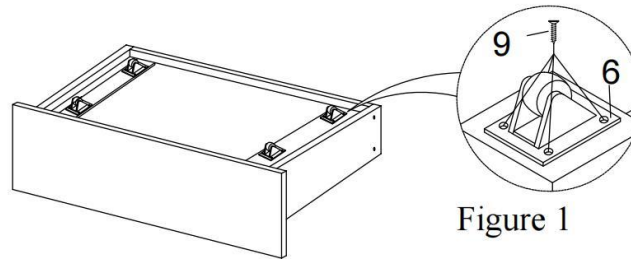
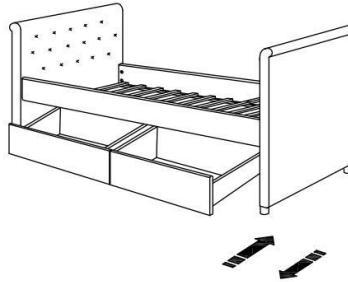

Figure 1

- 6 —  \*8 pcs
- 9 —  \*32 pcs

STEP 5: Push the Under Box of bed into the Bed.



**PLEASE DO NOT RETURN PRODUCT TO THE STORE.**

If you have any problem or concerns, please feel free to contact our customer service department. Please send your request to the following contact details according to the platform you purchased.



Walmart Platform:  
E-Mail: [wmcscr@comptree.net](mailto:wmcscr@comptree.net)  
Tel: 626-912-8886 Ext.100  
Other(Amazon, Wayfair, Homedepot, Overstock etc.) Platform:  
E-Mail: [csr@merax.com](mailto:csr@merax.com)  
Tel: 626-912-8886 Ext.100