





## CARE AND MAINTENANCE

Always use felt pads under all articles to prevent discoloration or softening of the lacquer. Plastic and rubber bases on items can discolor wood. Wipe up spills immediately and avoid common hazards such as hot dishes, harsh solvents and abrasives. Cleaning should be done with a soft lint free cotton cloth dampened with water or furniture polish. On highly used surfaces we recommend applying a quality paste wax which should be used on a regular basis to provide additional protection from scratches and spills. How often you apply the wax depends on how much wear the furniture receives.

## NOTICE

- \*Please make sure that you have all parts indicated before you begin assembly of this item
- \*This item should be assembled on a soft surface to prevent scratching the finish during assembly
- \*This item requires keep all screws loose and tighten TOGETHER after assembling

## Part List and Hardware List

| PIECE | PICTURE   | QUANTITY |
|-------|---|----------|
| A     |                          | 1x       |
| B     |                          | 4x       |
| C     |  (m6x16mm / 0.24"x0.63") | 12x      |
| D     |  (m6x16mm / 0.24"x0.63") | 12x      |
| E     |  (Φ4 / x0.16")           | 1x       |

Product Dimensions: 43.3Wx23.6D\*16.5H"

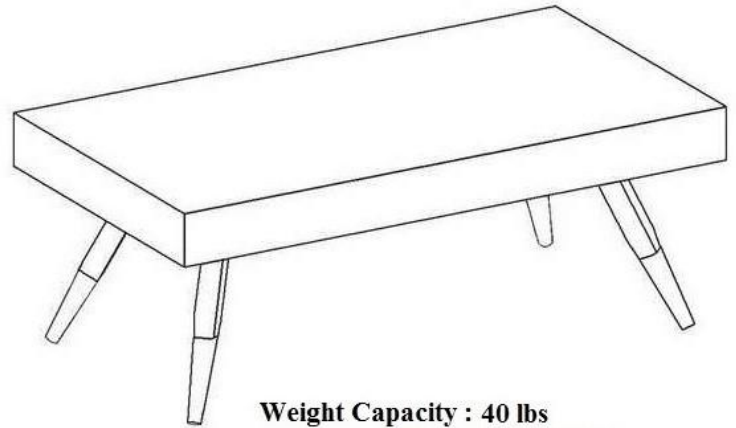

Weight Capacity : 40 lbs

Warning : Do not stand on table

Warning : Do not over torque bolts



Hardware is located inside the box. You can find them placed near the sign 'HARDWARE INSIDE'

## PREPARATION

Before beginning assembly of product, make sure all parts are presents. Compare parts with package contents list and hardware contents list. If any part is missing or damaged, do not attempt to assemble the product.  
Estimated Assembly Time: 20 minutes.

### Step:1

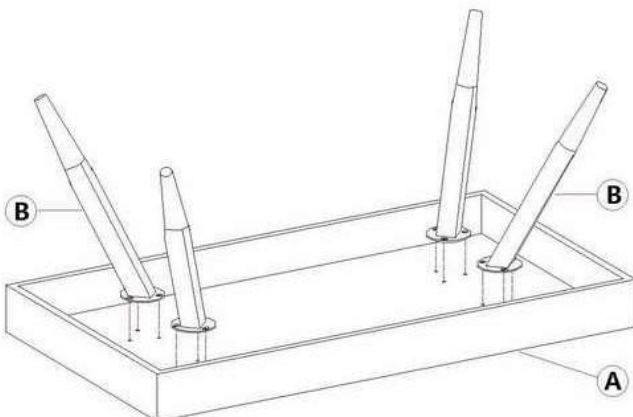

### Step:2

Please keep all screws loose and tighten TOGETHER after assembling.

