

ROYALCRAFT

Transforming houses into homes (English & Español)

ZLST006

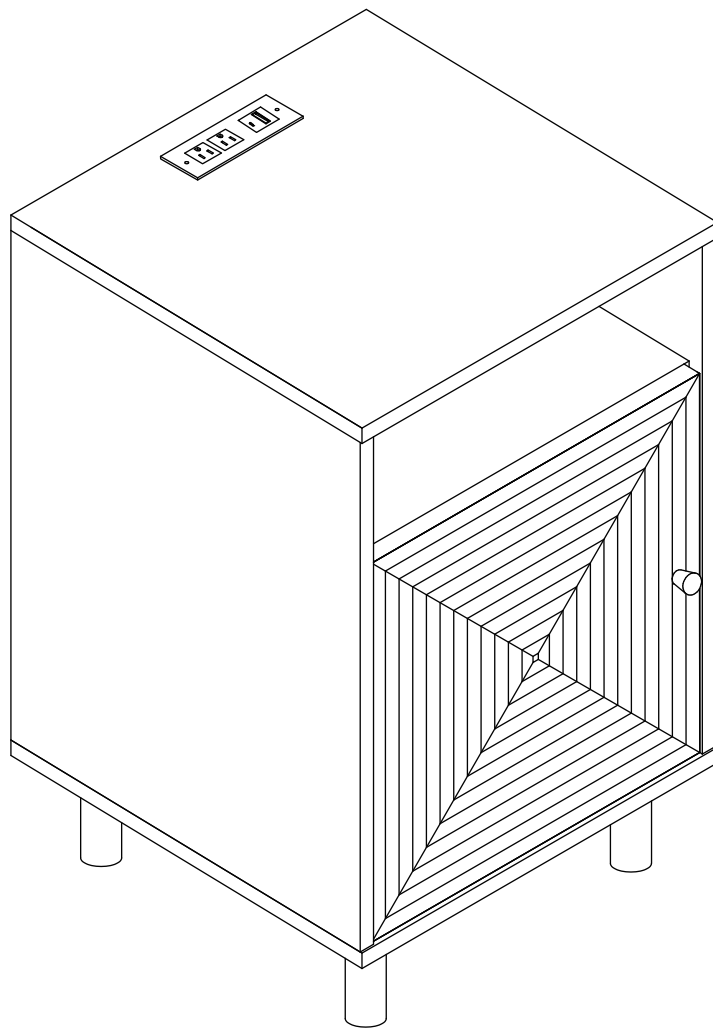

INSTRUCTION MANUAL

Contact Information

Question about your product? We're here to help. Contact us by:



707-392-8405



support@royalcraft.store

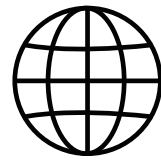

www.royalcraft.store



Orders FAQ



Product Assembly



Product Inquiry



Chat Support



Returns & Refunds

If you have any problems, please send your order number and photos to us. We will contact you within 24 hours and provide you with a satisfactory solution.

! NOTICE Please retain these instructions for future reference.

- Carefully unpack all the components and verify that all the necessary parts are included as listed in the packaging.
- Identify each component and refer to the provided assembly diagram or step-by-step instructions.
- Assemble the furniture in the order specified to ensure proper alignment and fit.
- Use the provided tools or recommended tools for assembly. Do not use excessive force when tightening screws or bolts.
- If any difficulties arise during assembly, consult the troubleshooting section or contact our customer support.

Watch&Learn

For ASSEMBLY videos and MAINTAIN tips



You can visit royalcraft.store

Or scan the QR

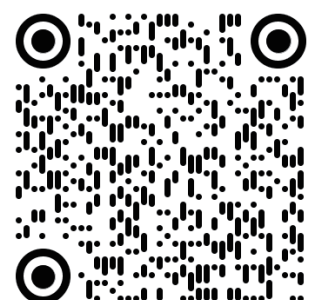

 ASSEMBLY INSTRUCTIONS

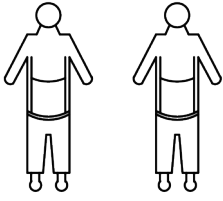

2 people

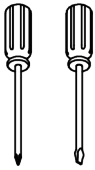



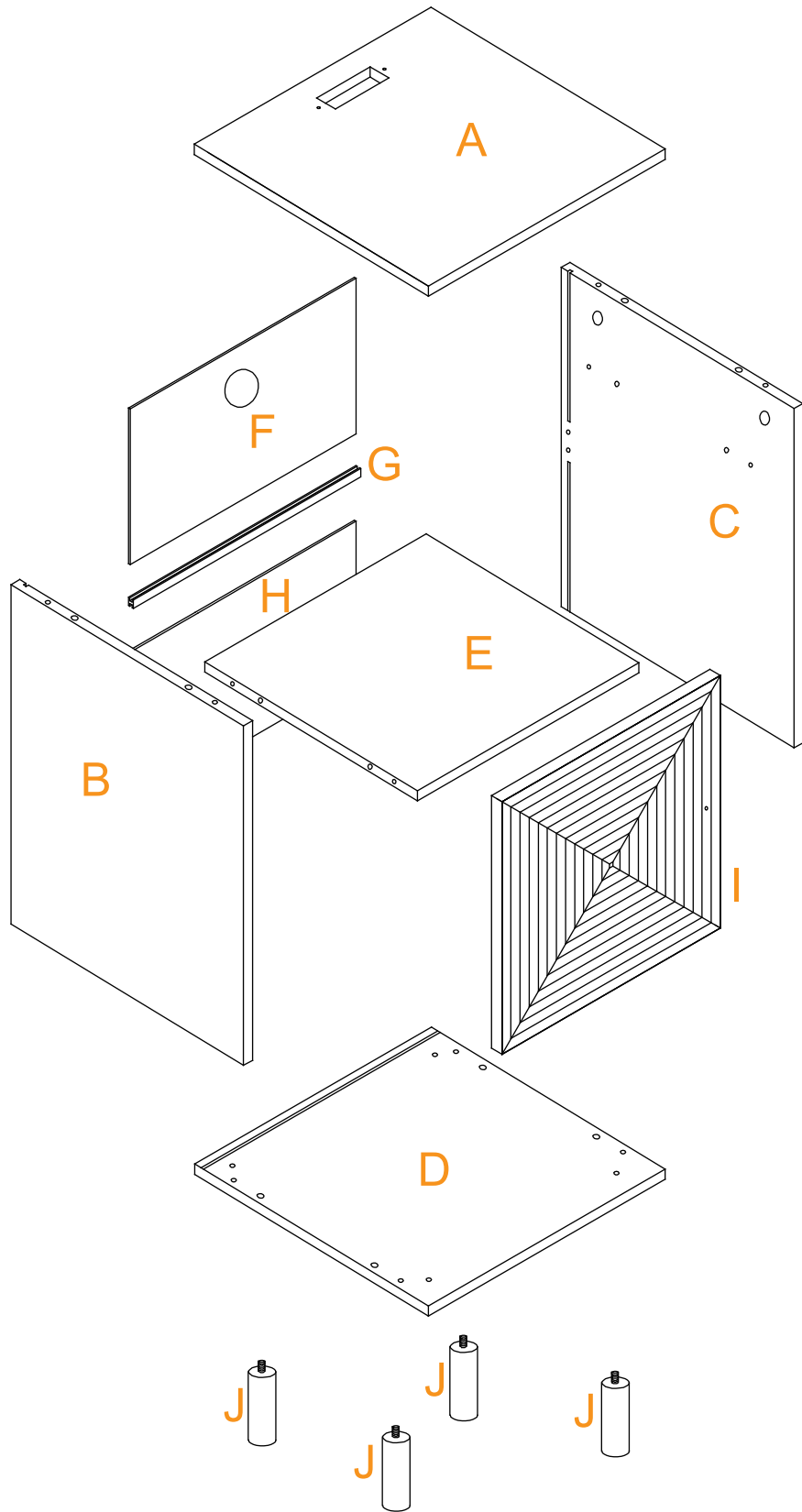



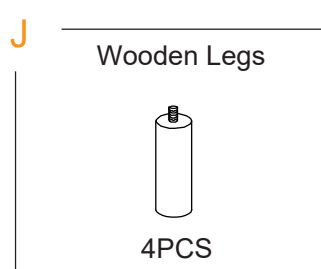
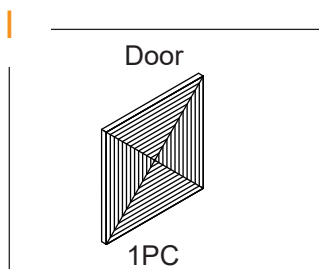
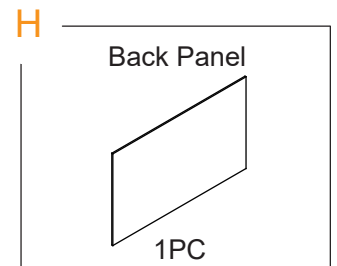
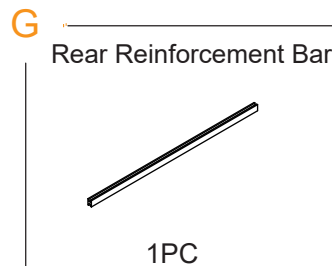
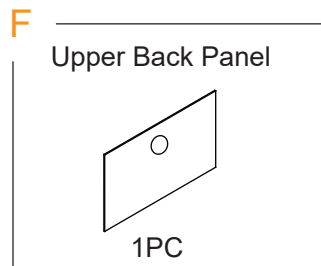
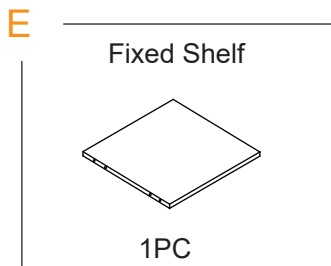
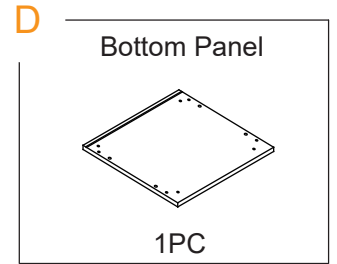
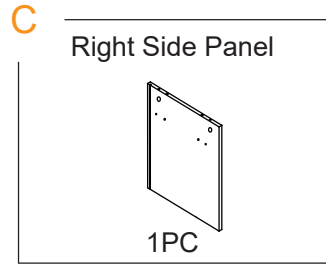
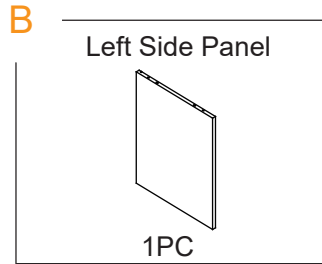
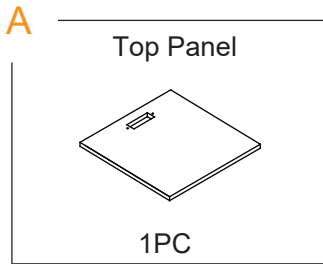



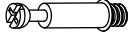





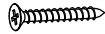



Phillips Screwdriver



☰ PARTS LIST



☰ HARDWARE LIST

- | | | | |
|--|--|--|---|
| <p>01</p> <p>Ø6x35mm
Cam Bolt</p>  <p>8+1 PCS</p> | <p>02</p> <p>Ø15x9.5mm
Cam Lock</p>  <p>8+1 PCS</p> | <p>03</p> <p>Ø6x30mm
Wood Dowel</p>  <p>12+1 PCS</p> | <p>04</p> <p>Ø7x40mm
Screw</p>  <p>4 PCS</p> |
| <p>05</p> <p>Ø4x14mm
Screw</p>  <p>12+1PCS</p> | <p>06</p> <p>Hinge</p>  <p>2 PCS</p> | <p>07</p> <p>Hole stickers</p>  <p>8 PCS</p> | <p>08</p> <p>Ø4x35mm
Screw</p>  <p>1 PC</p> |
| <p>09</p> <p>Foot pads</p>  <p>4 PCS</p> | <p>10</p> <p>Handle</p>  <p>1 PC</p> | <p>11</p> <p>4mm
Wrench</p>  <p>1 PC</p> | <p>12</p> <p>Back Panel Fastener</p>  <p>4 PCS</p> |
| <p>13</p> <p>Ø3x16mm
Screw</p>  <p>4 PCS</p> | <p>14</p> <p>Ø4x20mm
Screw</p>  <p>1 PC</p> | <p>15</p> <p>Ø3x10mm
Screw</p>  <p>2 PCS</p> | <p>16</p> <p>Power Socket</p>  <p>1 PC</p> |
| <p>17</p> <p>Anti-rewinding</p>  <p>1 PC</p> | <p>18</p> <p>Ø4x14mm
Screw</p>  <p>1 PC</p> | <p>19</p> <p>Washer</p>  <p>2 PCS</p> | <p>20</p> <p>Plastic swells</p>  <p>1 PC</p> |
| <p>21</p> <p>Anti-collision particles</p>  <p>2 PCS</p> | | | |

! If you are missing any parts, please provide your order number and circle the part number. Send us a photo of this, and we will provide you with a satisfactory solution. Thank you.

STEP 1

Please tighten the screws after completing all installation.

Por favor, apriete los tornillos después de instalar todo.

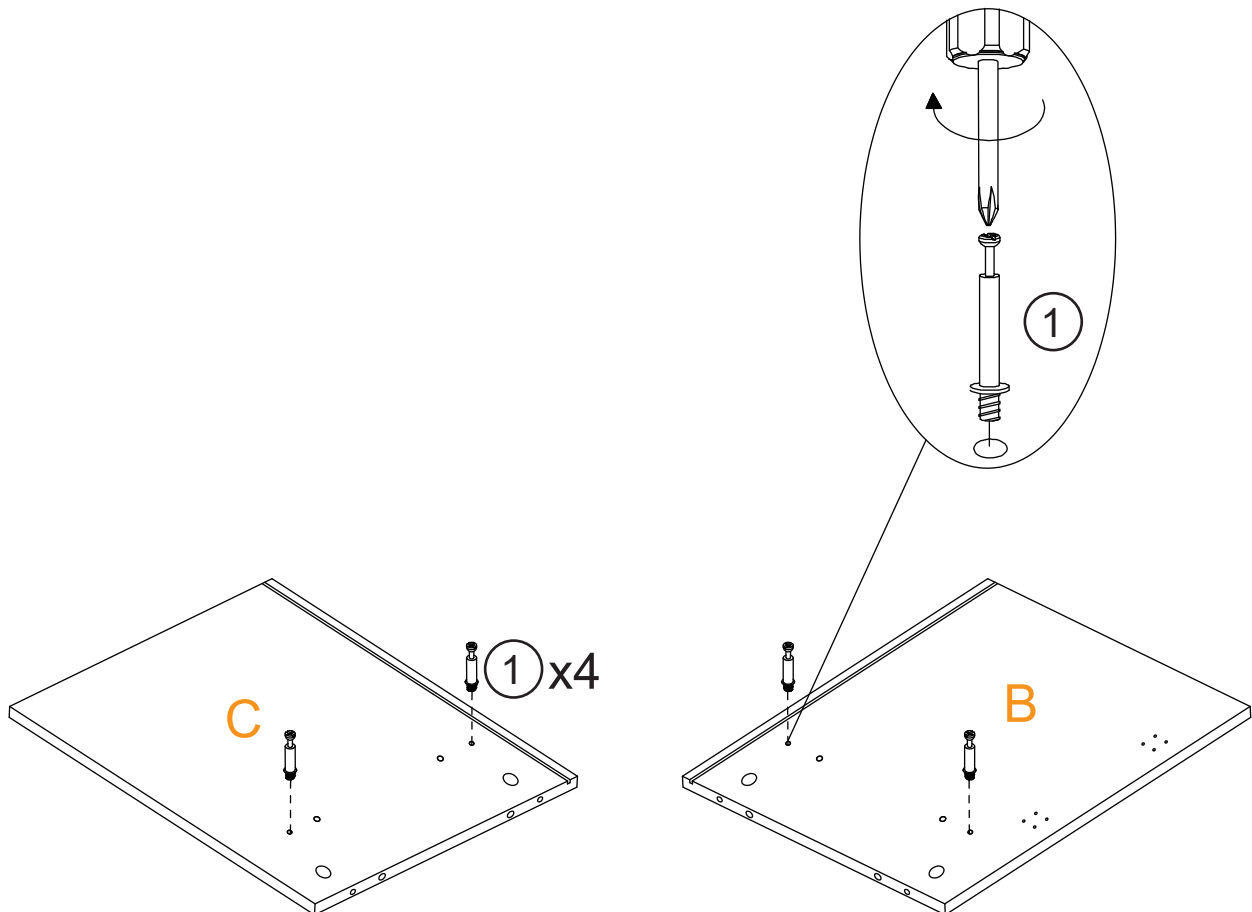
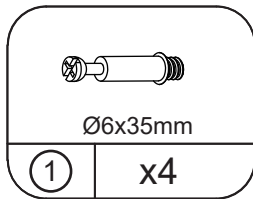

⚠ Reminder: Do not fully tighten any screws into threads during assembly. Tighten all screws only after assembly is complete.

STEP 2

Please tighten the screws after completing all installation.

Por favor, apriete los tornillos después de instalar todo.

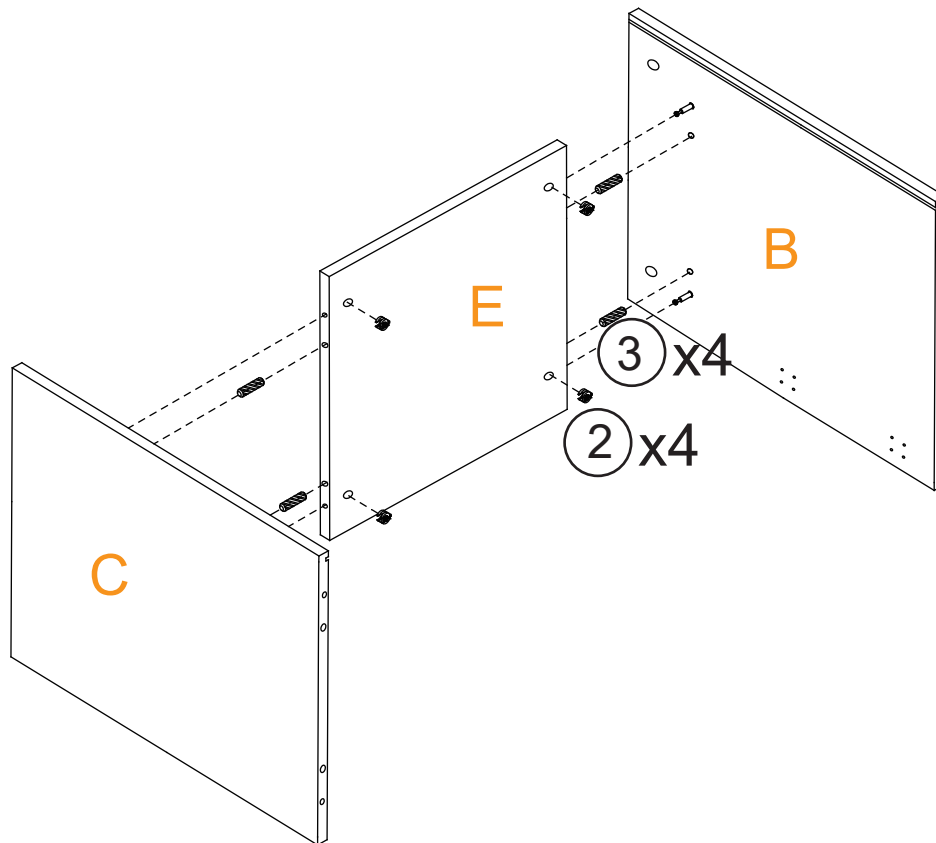
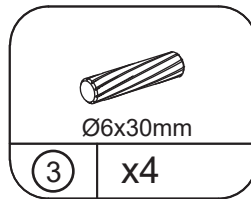
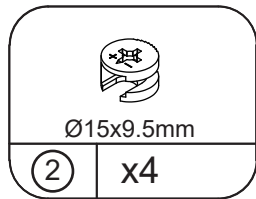

STEP 3

Please tighten the screws after completing all installation.

Por favor, apriete los tornillos después de instalar todo.

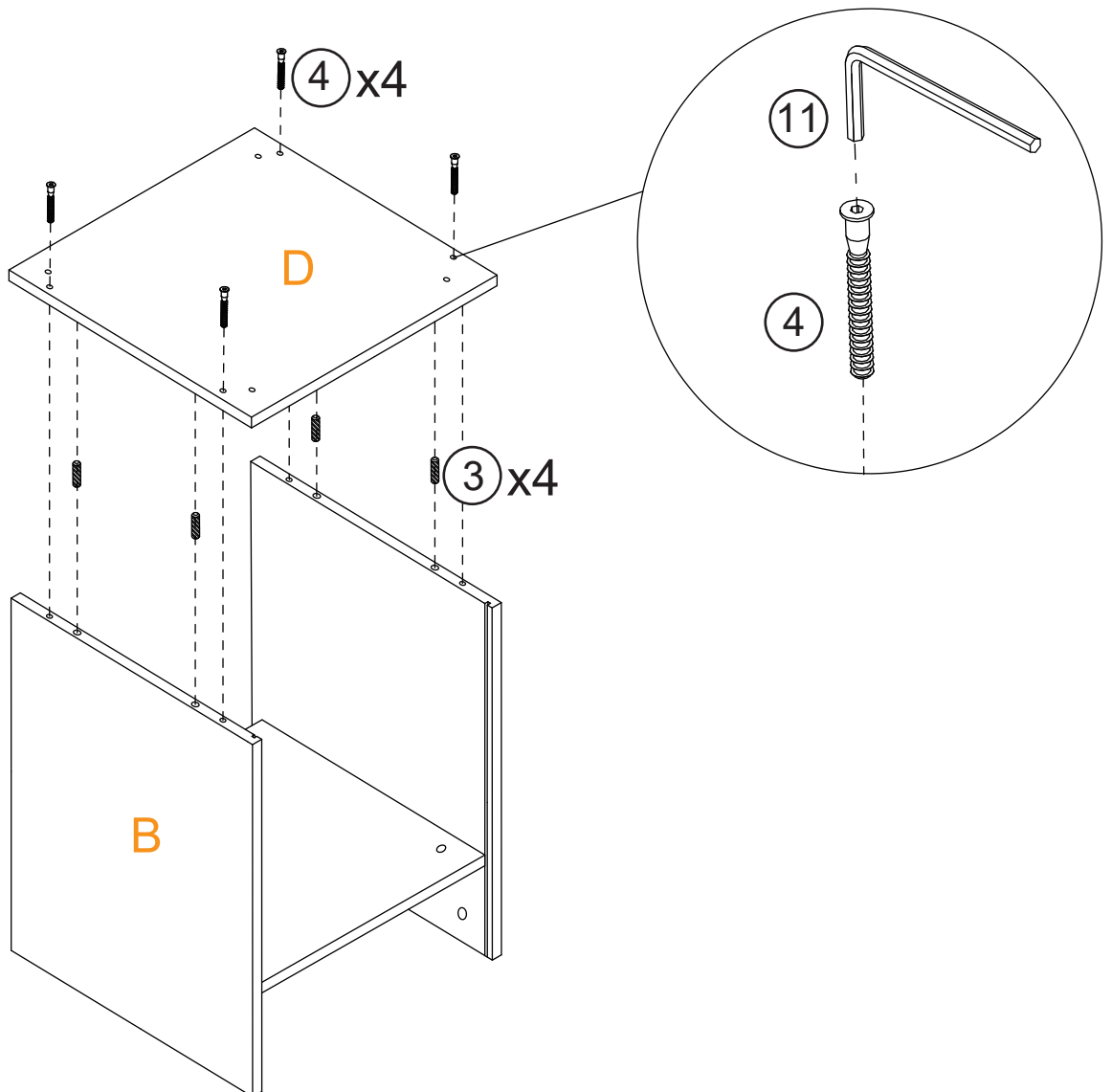
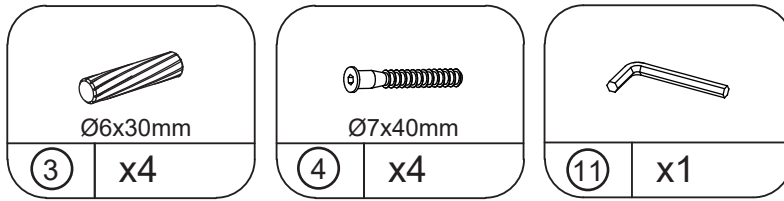

STEP 4 Please tighten the screws after completing all installation.

Por favor, apriete los tornillos después de instalar todo.

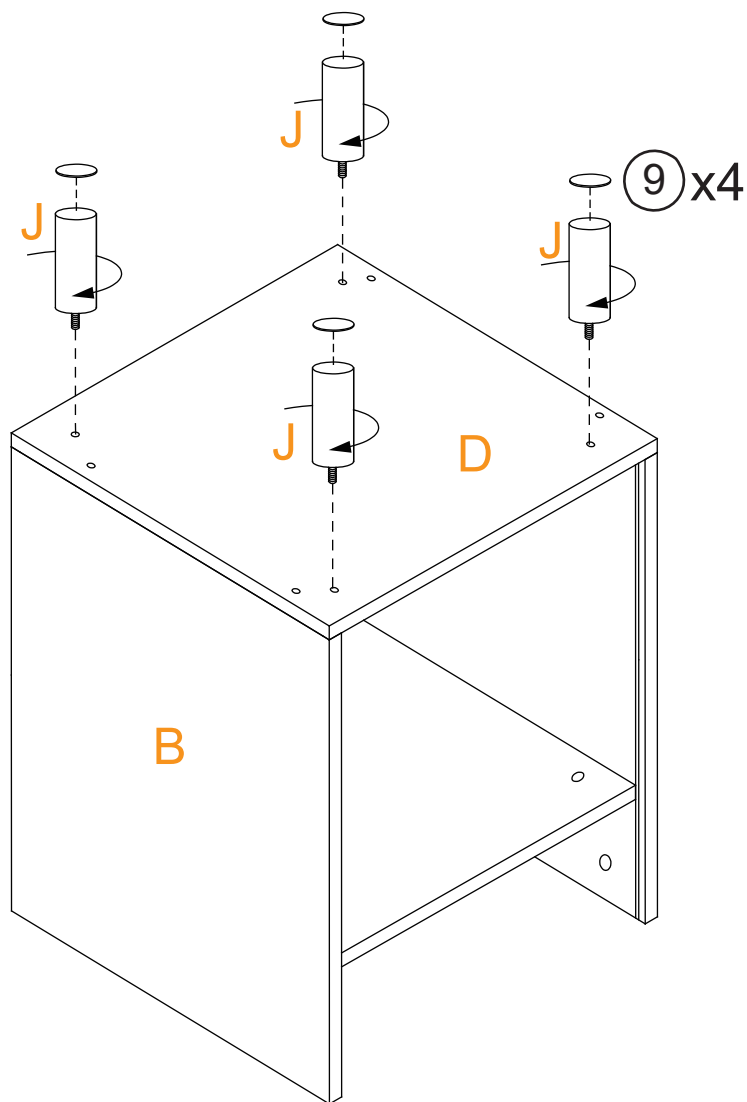
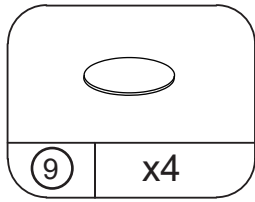

STEP 5

Please tighten the screws after completing all installation.

Por favor, apriete los tornillos después de instalar todo.

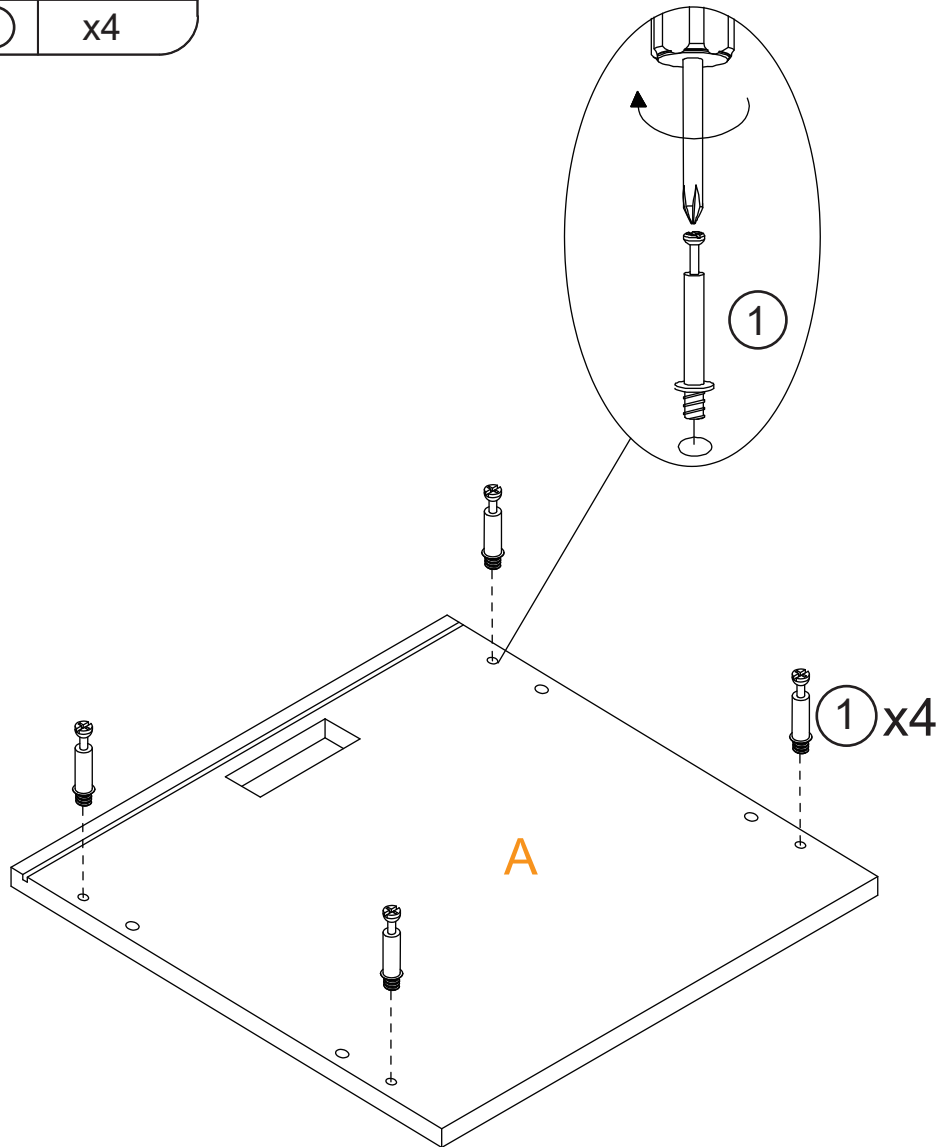
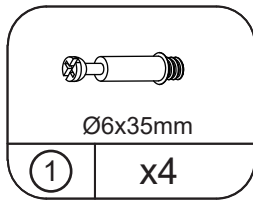

STEP 6 Please tighten the screws after completing all installation.

Por favor, apriete los tornillos después de instalar todo.

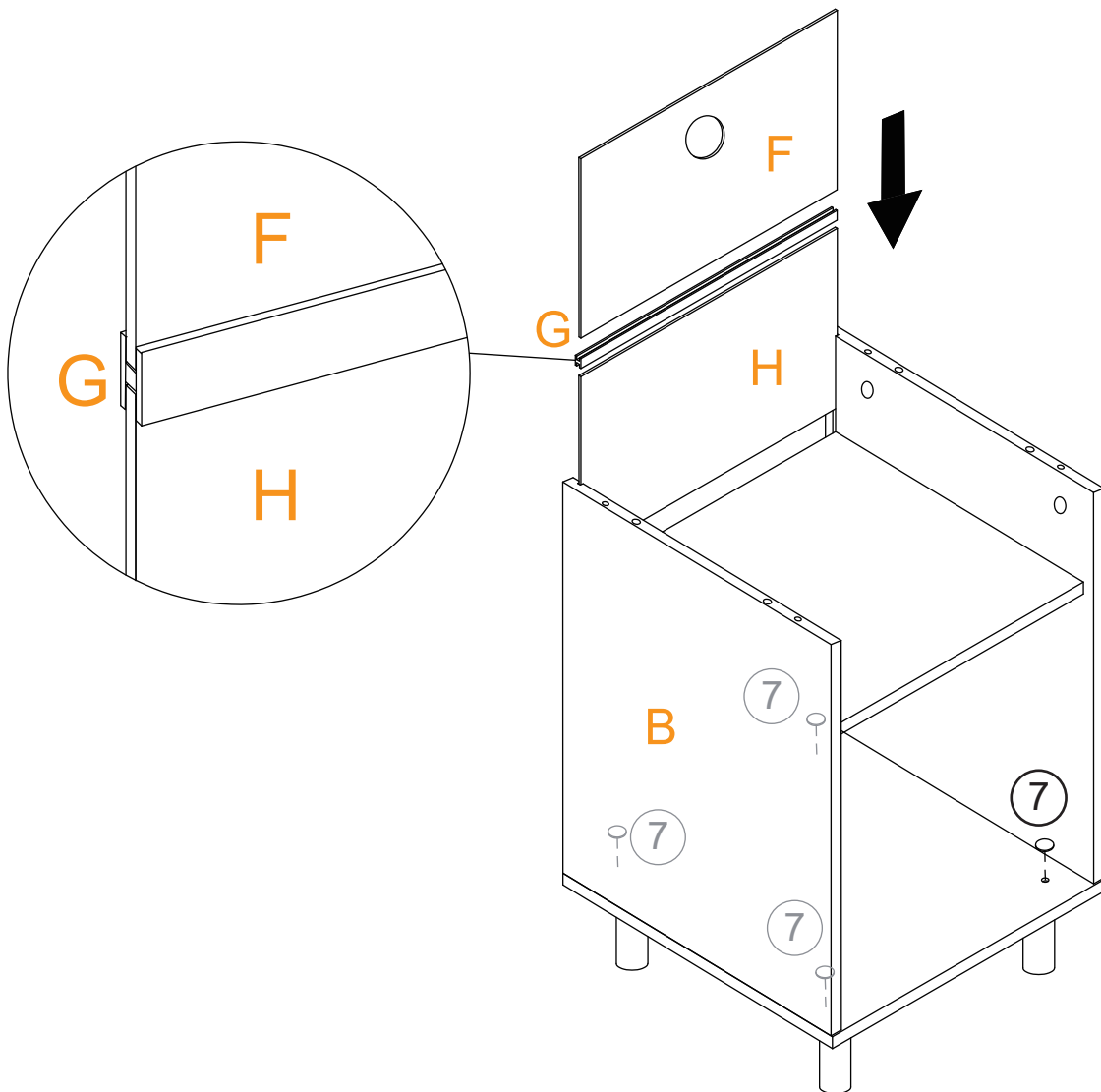
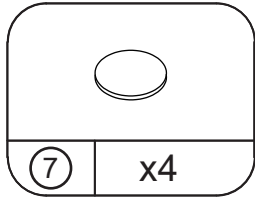

STEP 7

Please tighten the screws after completing all installation.

Por favor, apriete los tornillos después de instalar todo.

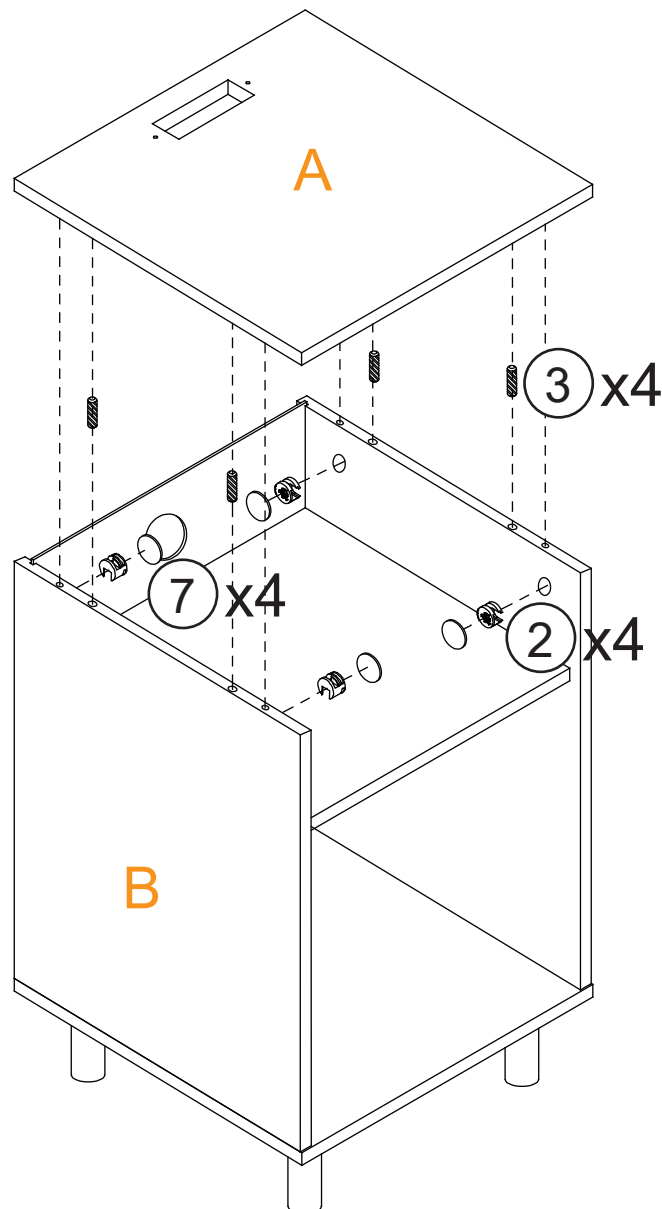
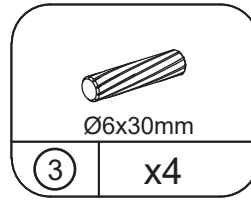
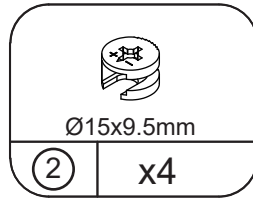
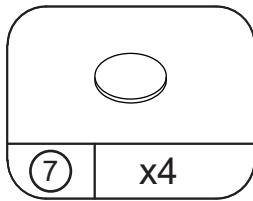

STEP 8 Please tighten the screws after completing all installation.

Por favor, apriete los tornillos después de instalar todo.

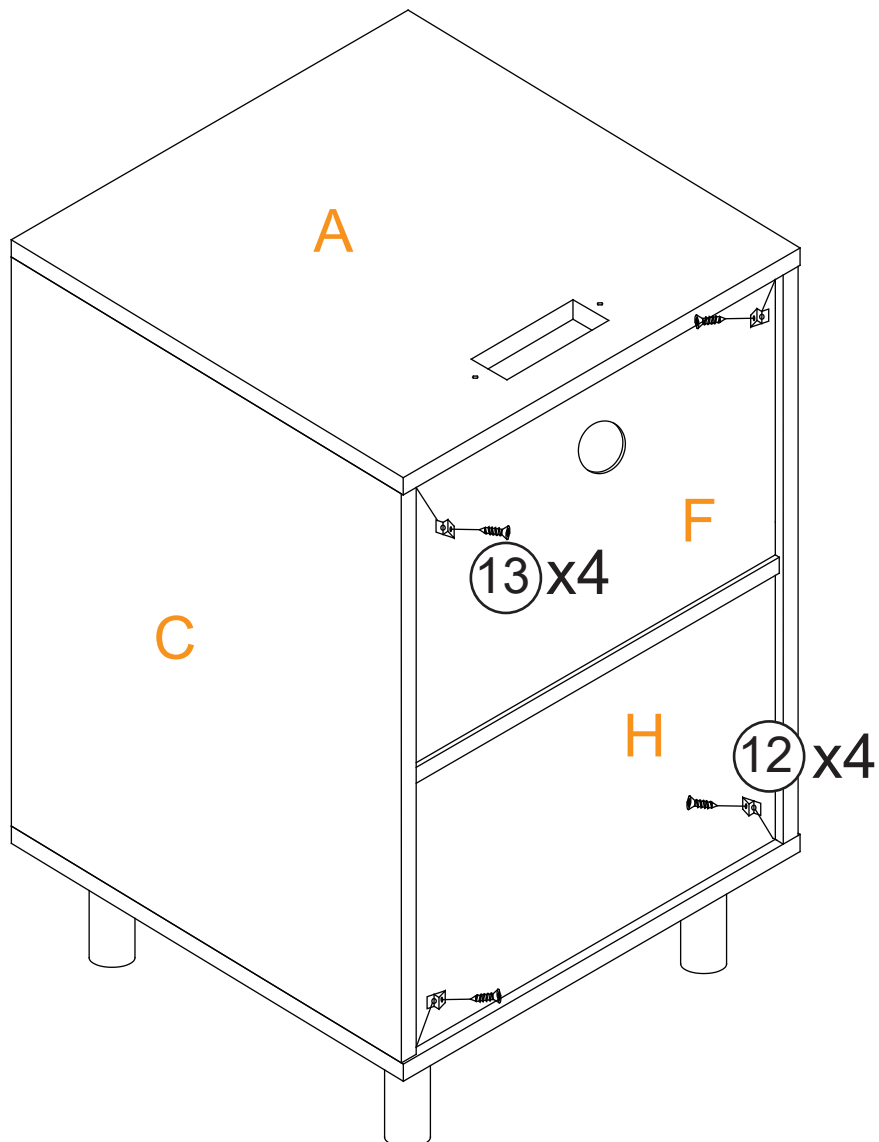
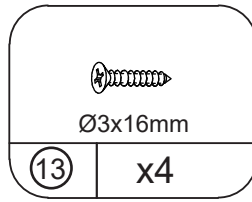
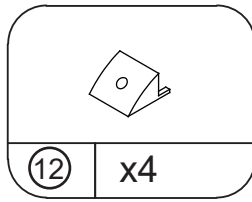

STEP 9

Please tighten the screws after completing all installation.

Por favor, apriete los tornillos después de instalar todo.

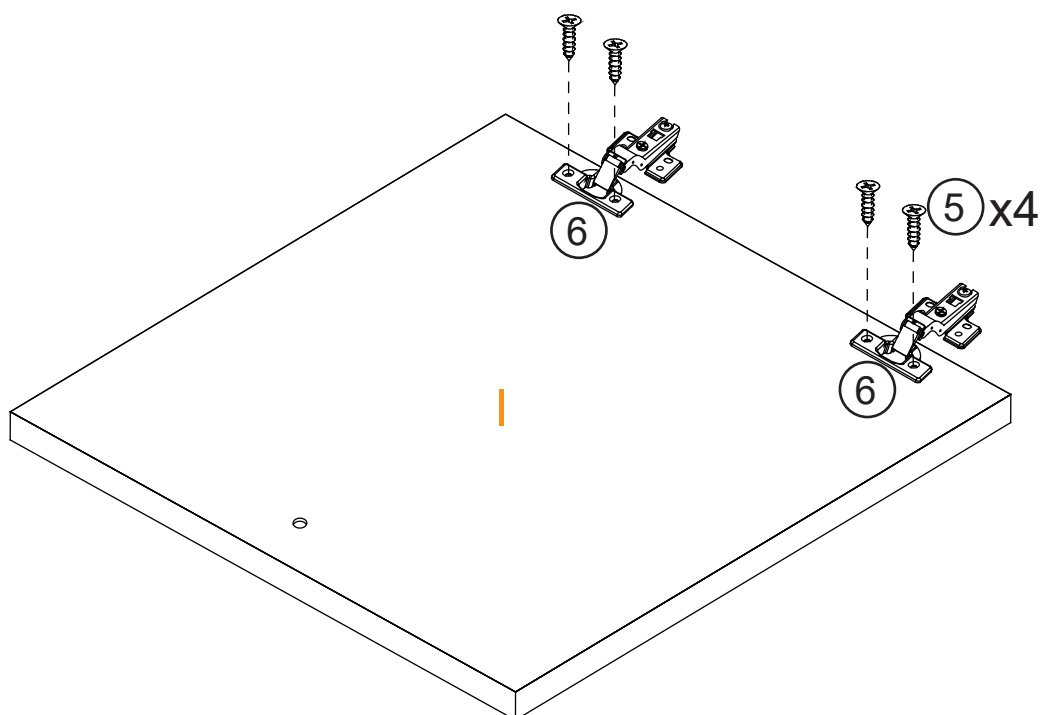
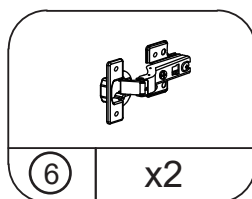
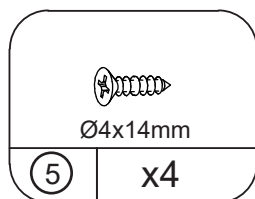

STEP 10

Please tighten the screws after completing all installation.

Por favor, apriete los tornillos después de instalar todo.

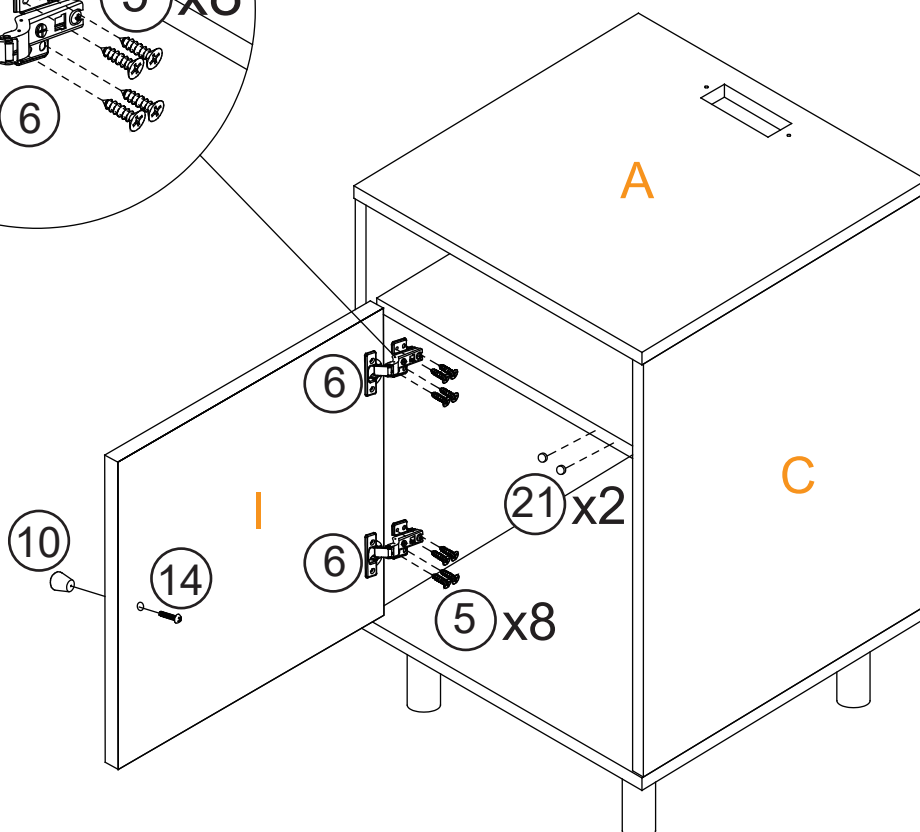
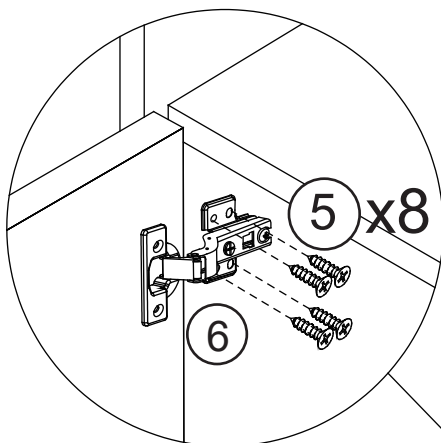
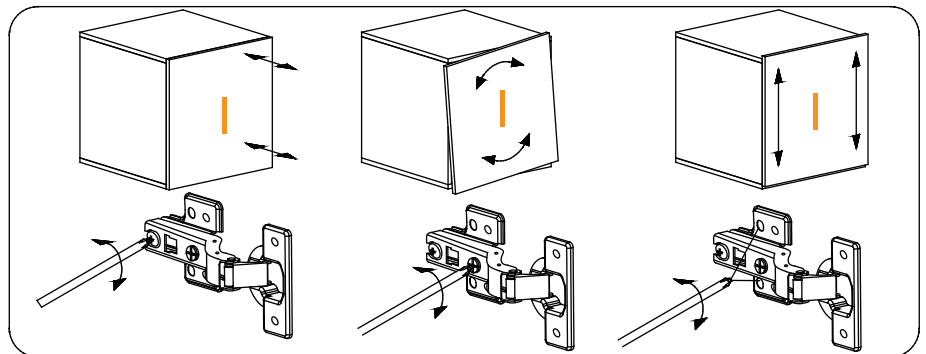
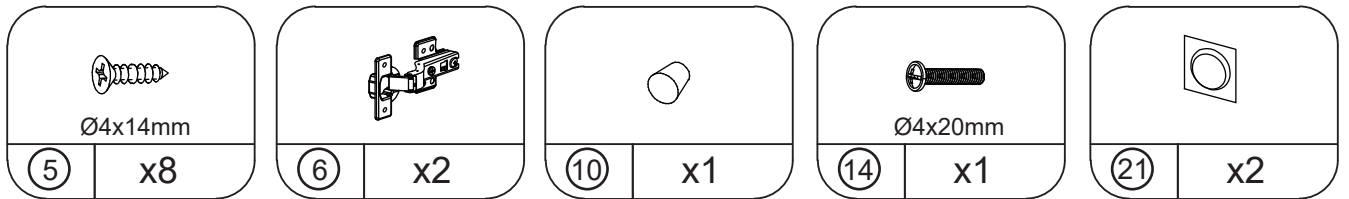

STEP 11

Please tighten the screws after completing all installation.

Por favor, apriete los tornillos después de instalar todo.

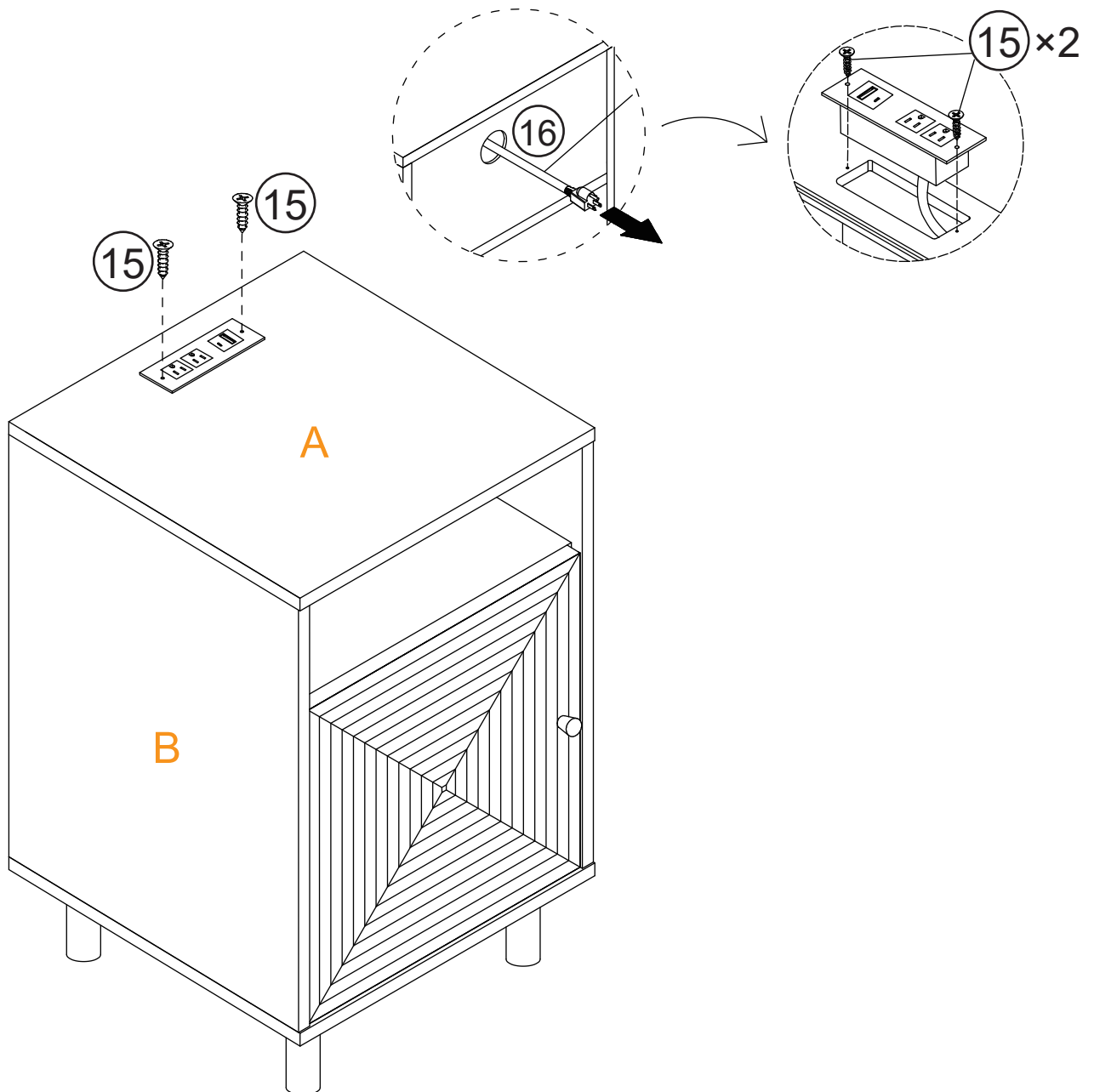
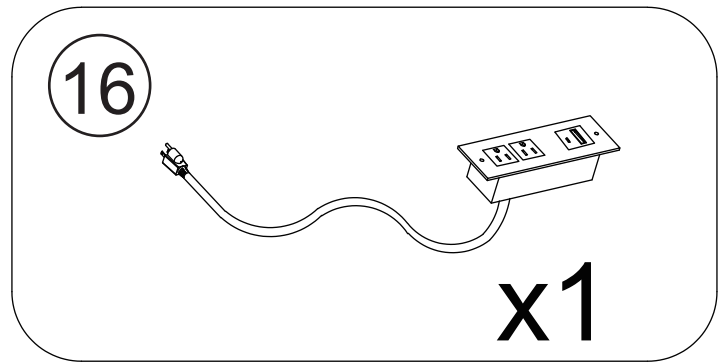
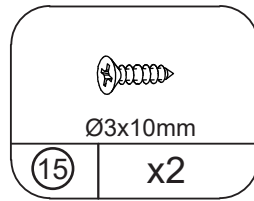
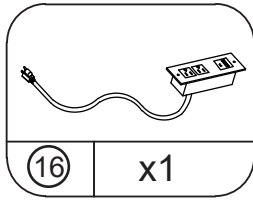

STEP 12

Please tighten the screws after completing all installation.

Por favor, apriete los tornillos después de instalar todo.

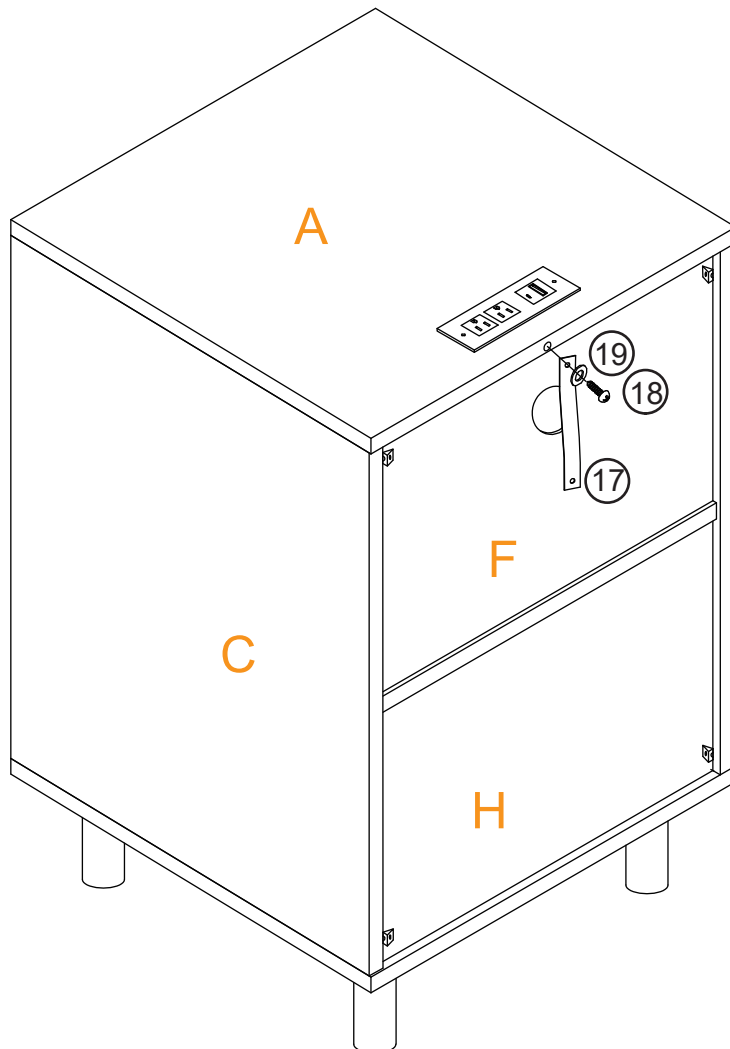
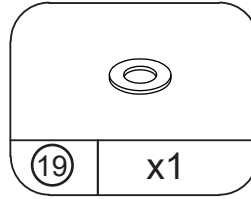
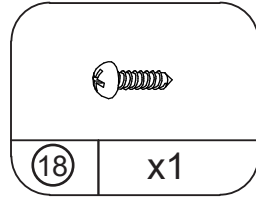
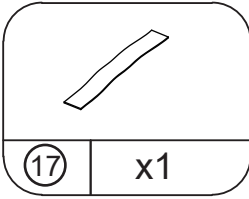

STEP 13

Please tighten the screws after completing all installation.

Por favor, apriete los tornillos después de instalar todo.

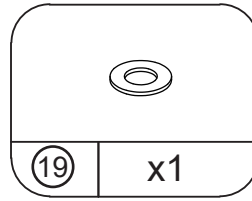
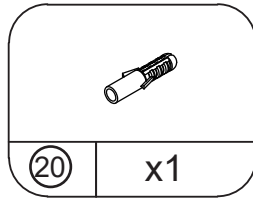
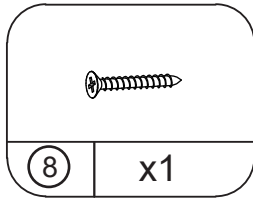

Pre-drilled hole at wall

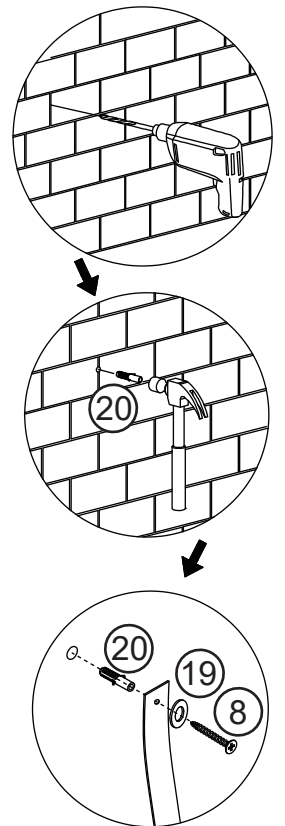
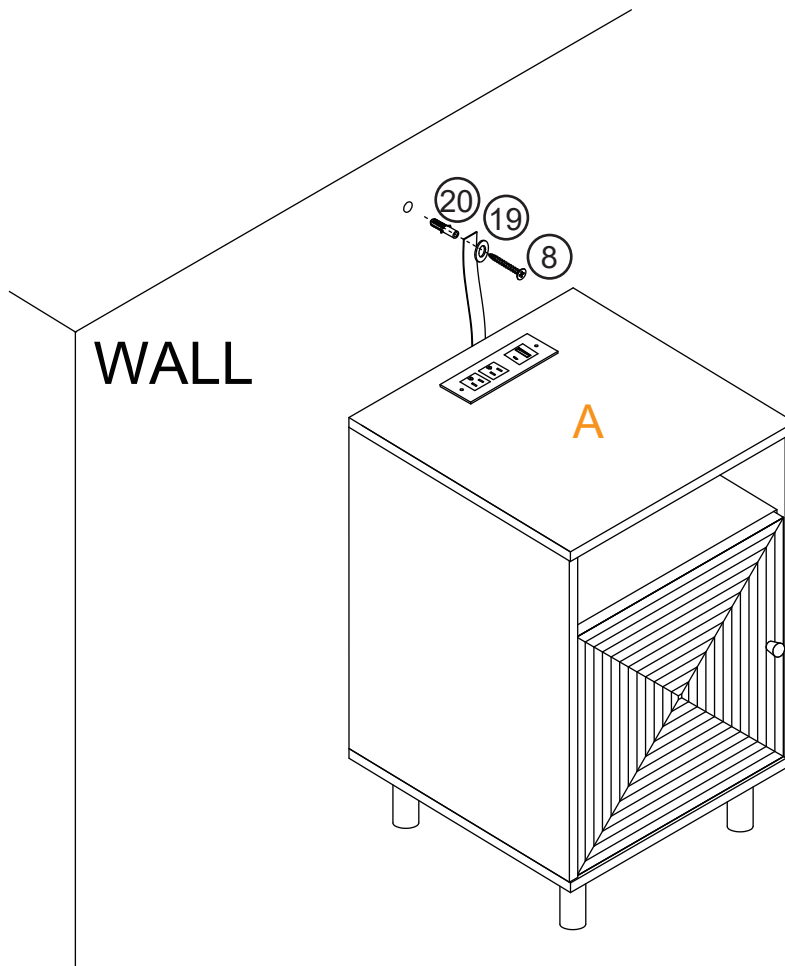

WARNING



Children have died from furniture tip-overs. To reduce the risk of furniture tip-overs:

- Always install the provided tip-over restraint.
- For use with televisions weighing 200 lbs or less. Using heavier televisions may result in instability, causing tip-overs and resulting in death or serious injury. Never use with CRT televisions.
- Never allow children to stand, climb, or hang on drawers, doors, or shelves.
- Never open more than one drawer at a time.
- Place heaviest items in the lowest drawers.
- Do not defeat or remove the drawer interlock system.

This is a permanent label. Do not remove it!



MAINTENANCE AND CARE

Prevent Moisture Damage:

Safeguard your laminate furniture by keeping it in a dry environment. Store the furniture away from damp areas and water sources.

Sunlight Shielding:

Shield your laminate furniture from direct sunlight to prevent color fading and surface deterioration. Consider using curtains or blinds for protection, especially if direct sunlight exposure is unavoidable.

Regular Care:

Maintain your laminate furniture's appearance by gently wiping surfaces with a damp cloth. Avoid using overly wet cloths or abrasive cleaning tools.

Avoid Scratches:

Protect the furniture surface from scratches by refraining from placing sharp or hard objects on it. When moving the furniture, be cautious not to scrape the legs against the floor.

Proper Weight Distribution:

Prevent structural damage by placing heavy objects on stable support surfaces rather than directly on the laminate furniture's surface. This simple step can prolong the life of your furniture.

Evite daños por humedad:

Proteja sus muebles laminados manteniéndolos en un ambiente seco. Guarde los muebles lejos de zonas húmedas y fuentes de agua.

Protéjalos de la luz solar:

Proteja sus muebles laminados de la luz solar directa para evitar la pérdida de color y el deterioro de la superficie. Considere el uso de cortinas o persianas como protección, especialmente si la exposición directa a la luz solar es inevitable.

Cuidado regular:

Mantenga el aspecto de sus muebles laminados limpiando suavemente las superficies con un paño húmedo. Evite utilizar paños demasiado húmedos o herramientas de limpieza abrasivas.

Evite los arañazos:

Proteja la superficie del mueble de arañazos evitando colocar objetos afilados o duros sobre ella. Al mover el mueble, tenga cuidado de no raspar las patas contra el suelo.

Distribución adecuada del peso:

Evite daños estructurales colocando objetos pesados sobre superficies de apoyo estables en lugar de directamente sobre la superficie del mueble laminado. Este sencillo paso puede prolongar la vida de sus muebles.

Warranty Coverage: Our warranty provides protection against manufacturing defects in materials and workmanship for a specified period from the date of purchase, as outlined in the accompanying warranty documentation.

Exclusions: The warranty does not cover damages resulting from misuse, negligence, accidents, normal wear and tear, unauthorized repairs or modifications, improper assembly, or failure to adhere to the care and maintenance guidelines provided.

WARRANTY CLAIM PROCESS

To initiate a return on Amazon, please follow these steps:

1. Log into your Amazon account and go to the "Your Orders" section.
2. Locate the order containing the item you wish to return.
3. Contact our customer service for assistance in obtaining a prepaid return label.
4. Once you receive the return label, securely affix it to the package.
5. You can then choose to drop off the package at a designated carrier location or arrange for a pickup.
6. After we receive and inspect the returned product, we will initiate the refund process.
7. The refund will be credited back to the original payment method used during the purchase.
8. Typically, refunds are processed within 3-5 business days.

Warranty Coverage: Our warranty provides protection against manufacturing defects in materials and workmanship for a specified period from the date of purchase, as outlined in the accompanying warranty documentation.

Exclusions: The warranty does not cover damages resulting from misuse, negligence, accidents, normal wear and tear, unauthorized repairs or modifications, improper assembly, or failure to adhere to the care and maintenance guidelines provided.

PROCESO DE RECLAMACIÓN DE LA GARANTÍA

Para iniciar una devolución en Amazon, siga estos pasos:

1. Accede a tu cuenta de Amazon y ve a la sección "Tus pedidos"
2. Localiza el pedido que contiene el artículo que deseas devolver.
3. Ponte en contacto con nuestro servicio de atención al cliente para que te ayuden a obtener una etiqueta de devolución prepagada.
4. Una vez que reciba la etiqueta de devolución, fijela firmemente al paquete.
5. A continuación, puede optar por depositar el paquete en el lugar designado por el transportista o solicitar que lo recojan.
6. Después de que recibamos e inspeccionemos el producto devuelto, iniciaremos el proceso de reembolso.
7. El reembolso se abonará de nuevo al método de pago original utilizado durante la compra.
8. Normalmente, los reembolsos se procesan en un plazo de 3 a 5 días laborables.

★ SHARE YOUR SPACE ★

We love to see where our furniture ends up-
snap a pic and tag if on Instagram or Face-
-book for your chance to be featured on our
social channels and WIN A PRIZE



LEARN MORE

★ COMPARTE SU ESPACIO ★

Nos encanta ver dónde acaban sus muebles. Tome
una foto y etiquétela en Instagram o Facebook para
tener la oportunidad de apa-recer en nuestros canales
sociales y GANAR UN PREMIO.



@royalcrafthome



707-392-8405



support@royalcraft.store



www.royalcraft.store



[Royalcrafthome](#)

**If you have any problems, please send your order number and photos to us.
We will contact you within 24 hours and provide you with a satisfactory solution.**