

Assembly Instructions

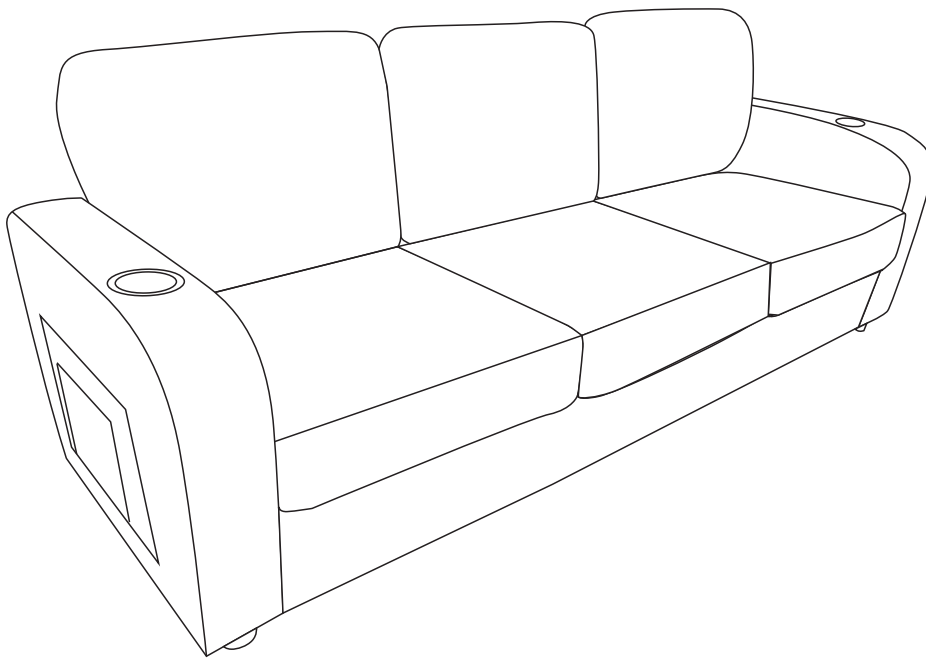

A-R



1pcs

A-L

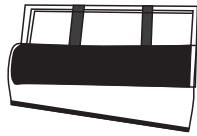

1pcs

B-R

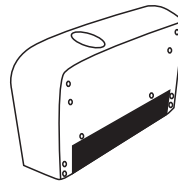

1pcs

B-L

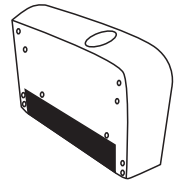

1pcs

C

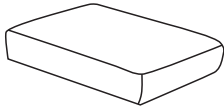

3pcs

D

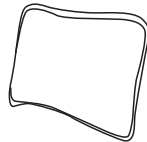

3pcs

E

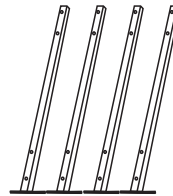

4pcs

F



2pcs

G

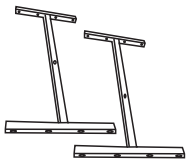

2pcs

H



21pcs

I

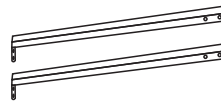

2pcs

J



1pcs

K

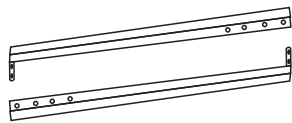

2pcs

L

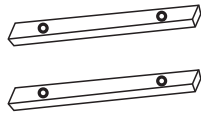

2pcs

M

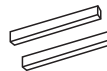

2pcs

N



2pcs

O

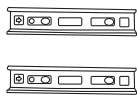

2pcs

P



M6x35mm

12pcs

Q



M6x30mm

12pcs

R



M8x50mm

4pcs

S



M6x20mm

36pcs

T



8x22

4pcs

U



M6

1pc

V



4pcs

W

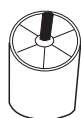

4pcs

X



5cm

4pcs

■ Step 1

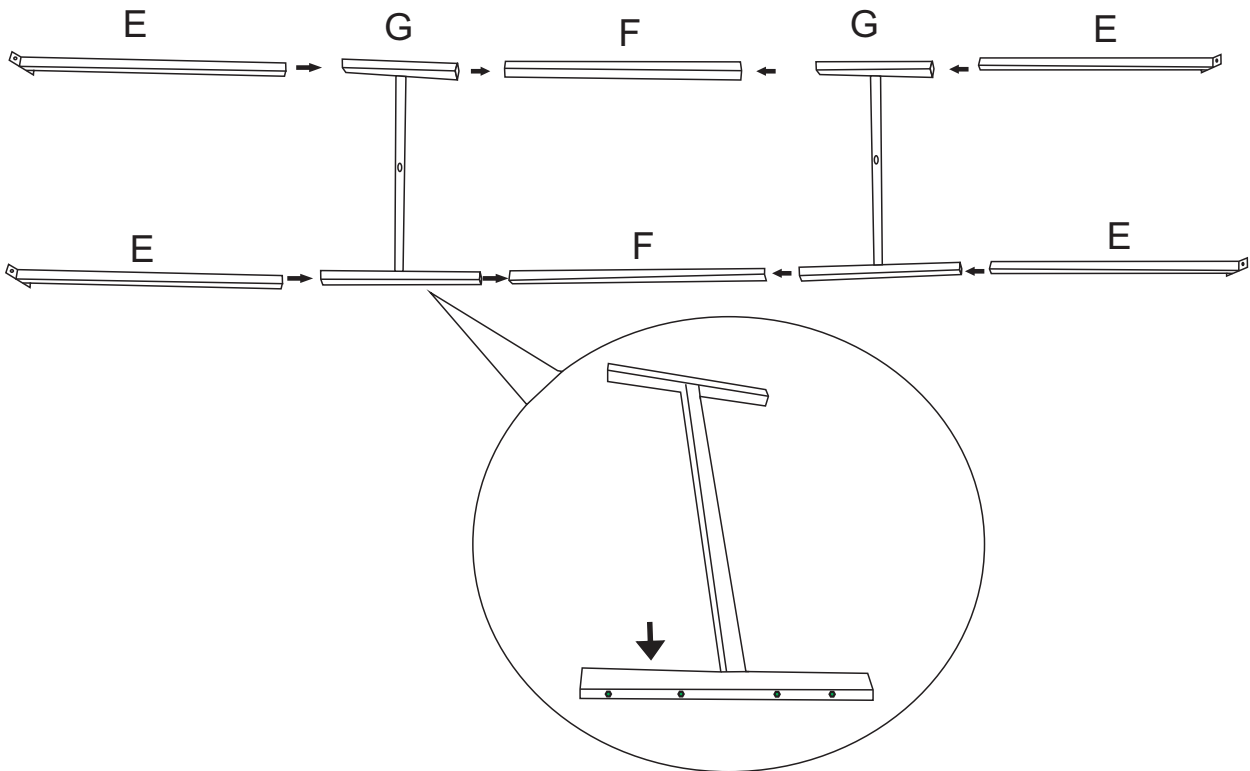

■ Step 2



Ⓢ 8 pcs
(M6x20)

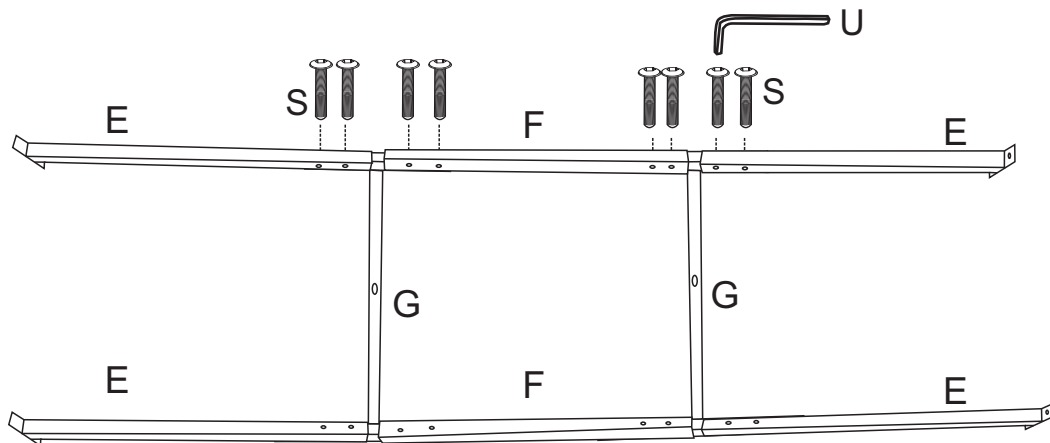

Ⓤ 1 pc



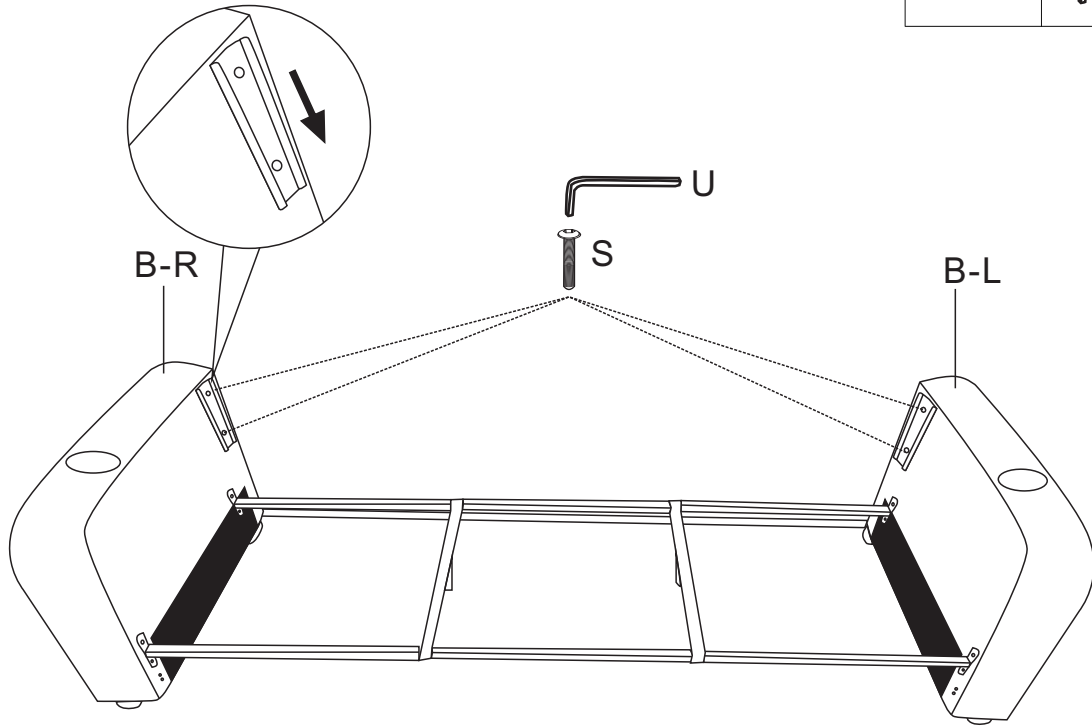

■ Step 5

S 4pcs (M6x20)	
O 2pc	
U 1 pc	



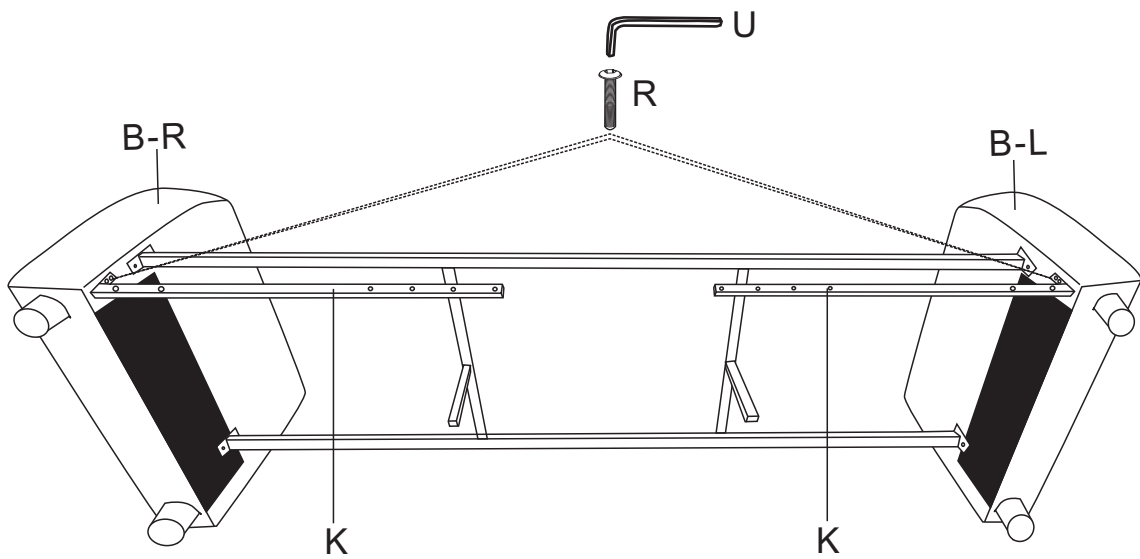

■ Step 6

R 2pcs (M8x50)	
U 1 pc	



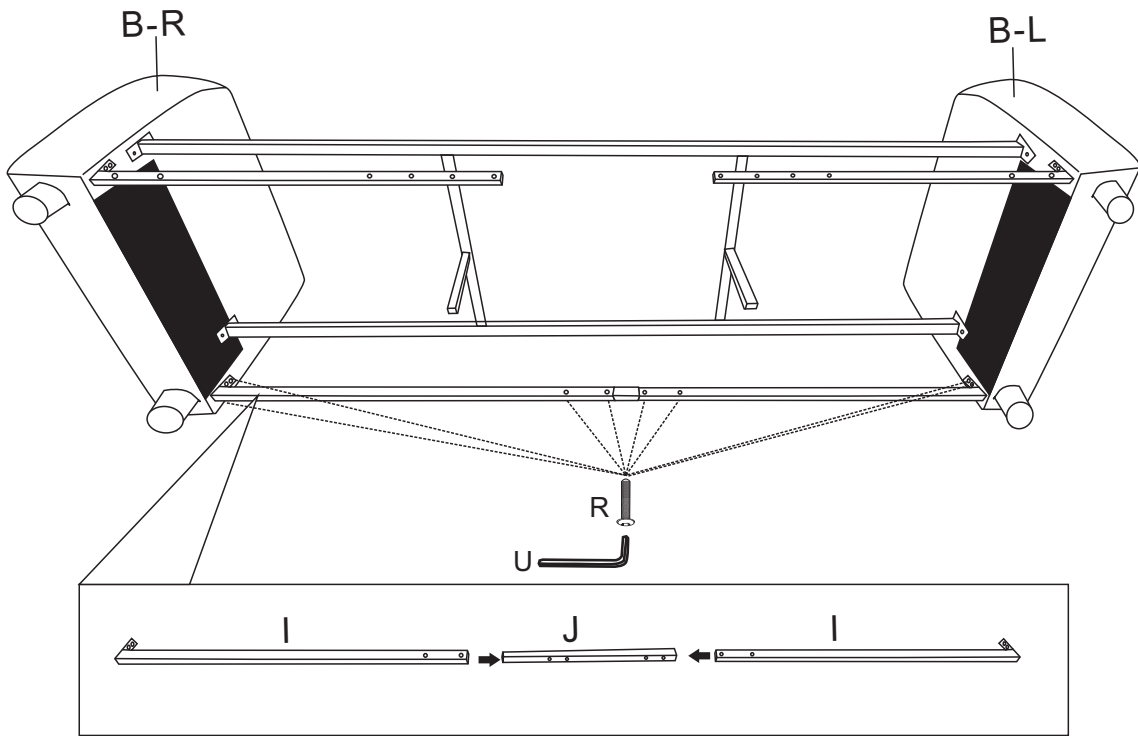

■ Step 7

S 8 pcs (M6x20)	
U 1 pc	



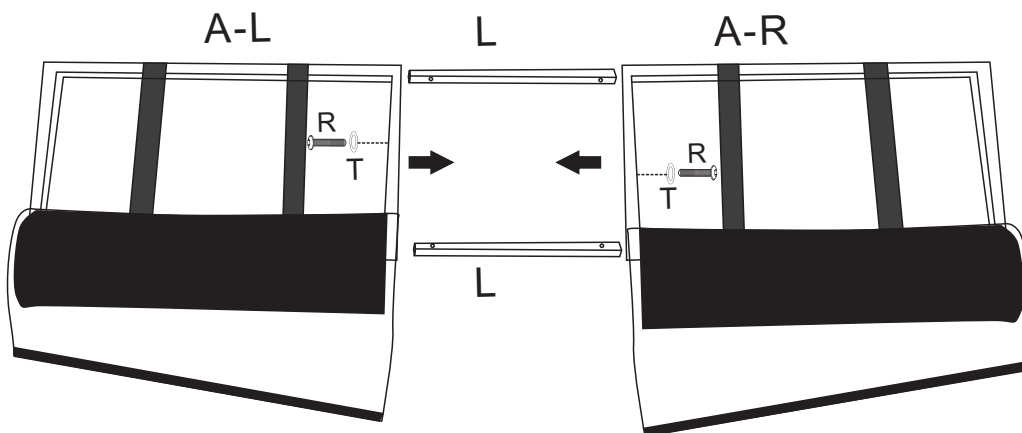

■ Step 8

R 2 pcs (M8x50)	
T 2 pc	
U 1 pc	



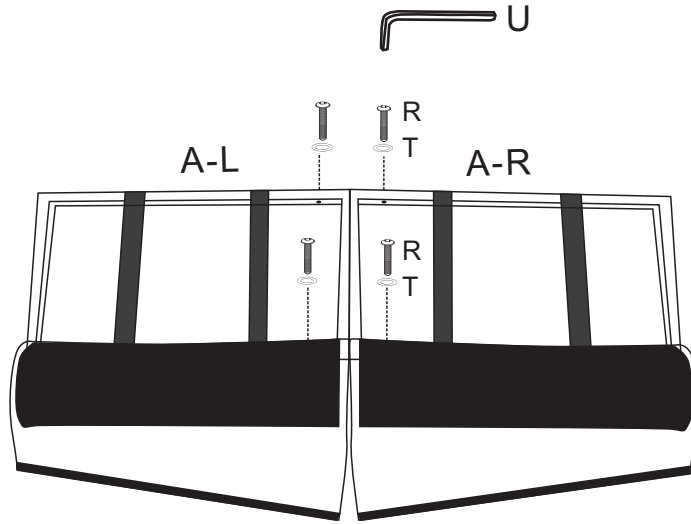

■ Step 9

R 4pcs (M6x20)	
T 4 pc	
U 1 pc	



■ Step 10

Q 12pcs (M6x30)	
U 1 pc	

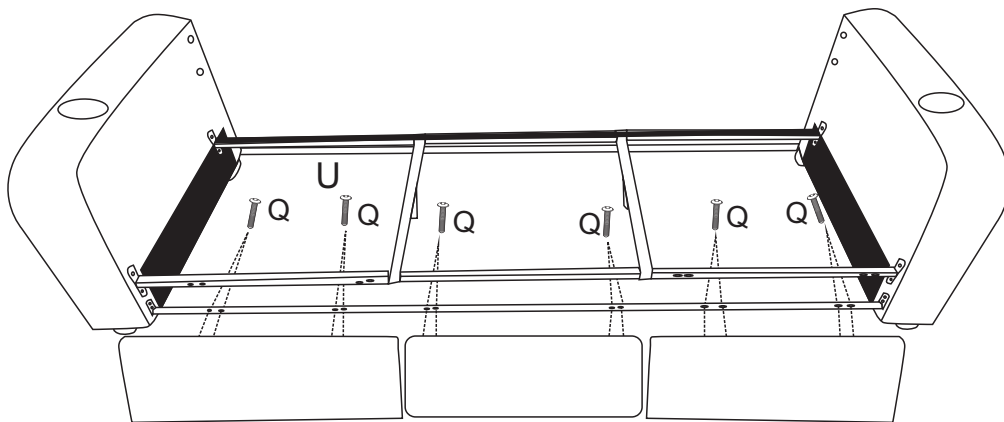

■ Step 11

P 12 pcs
(M6x35)



U 1 pc

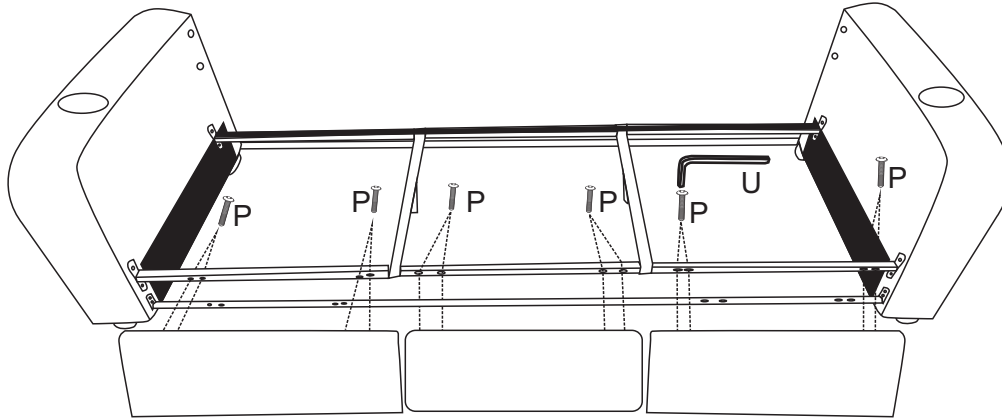

■ Step 12

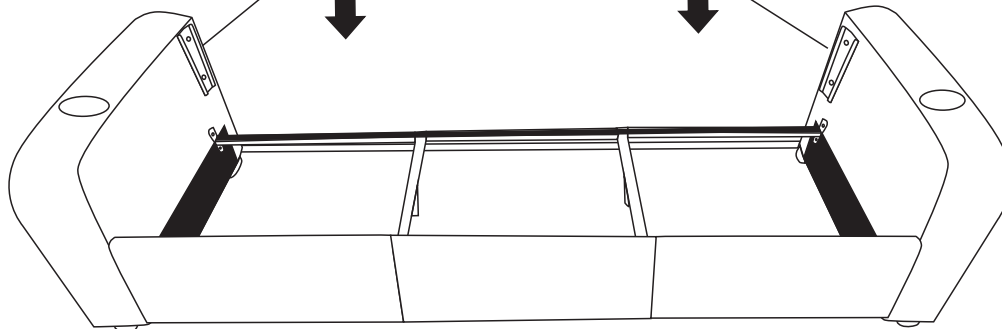
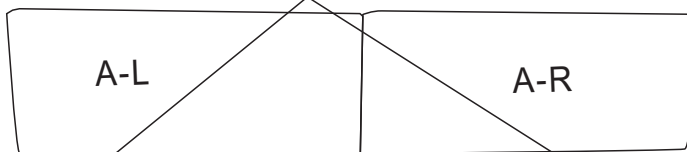
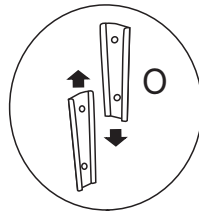

■ Step 13

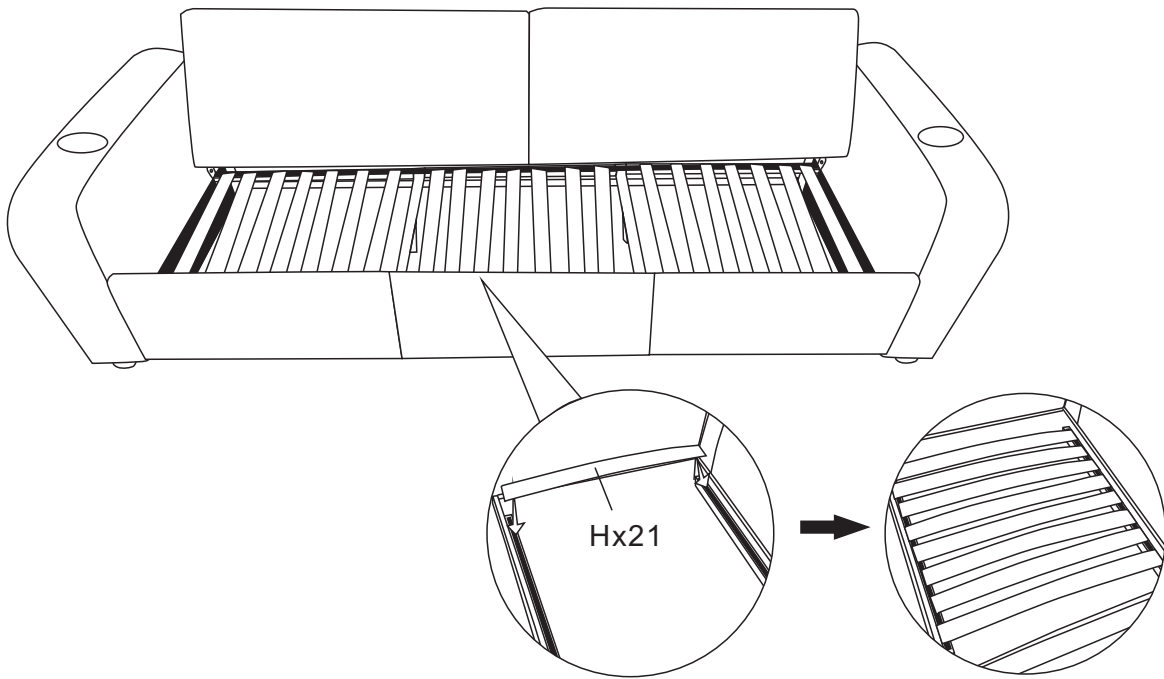

■ Step 14

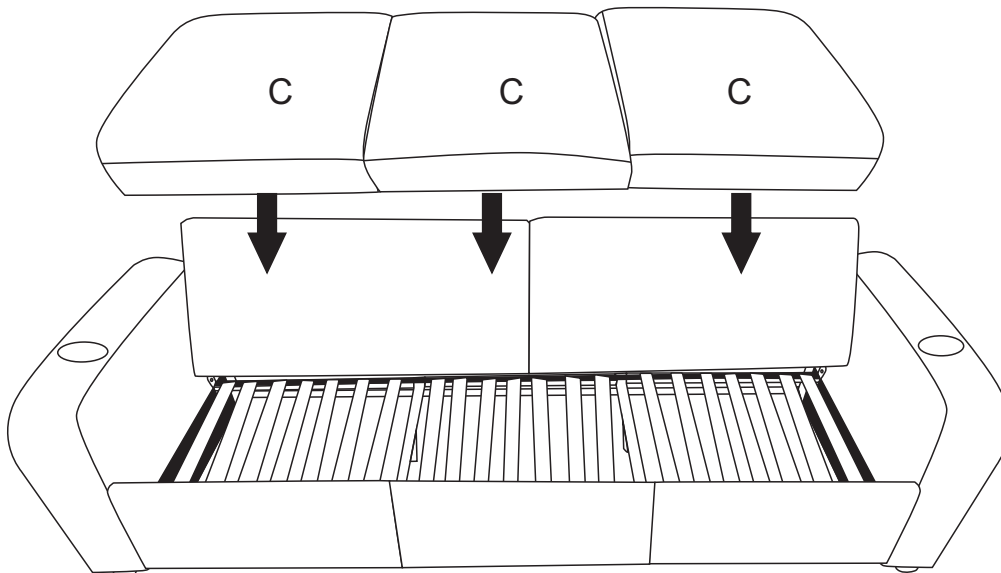

■ Step 16

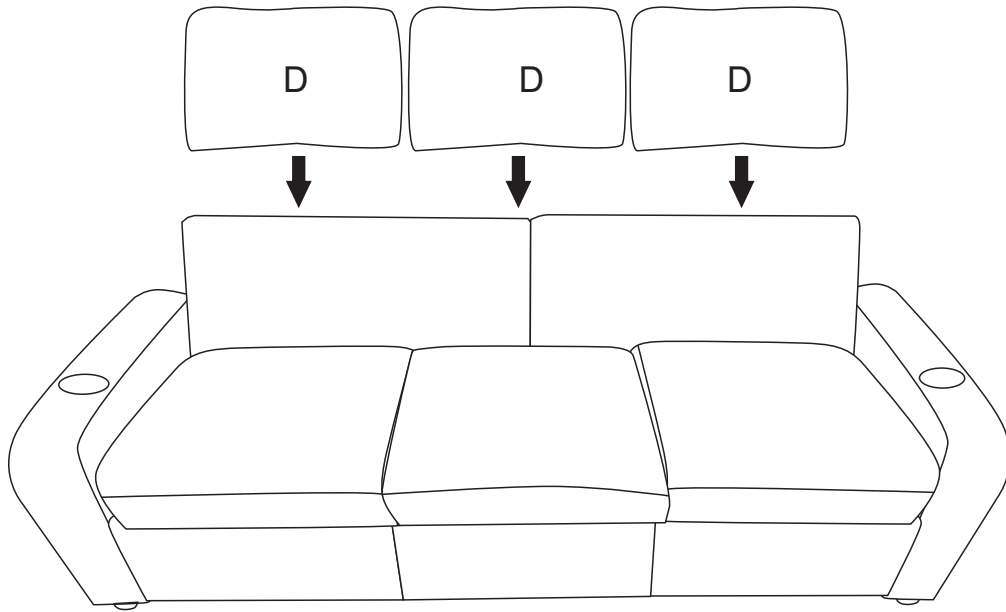

■ Step 17

COMPLETE!

