

STEP 3

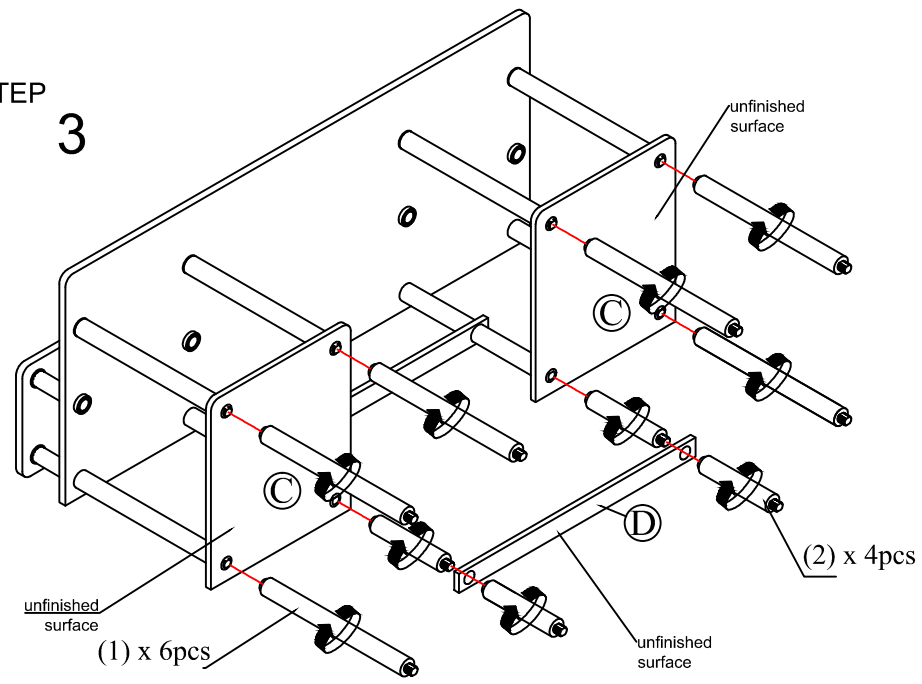

STEP 4

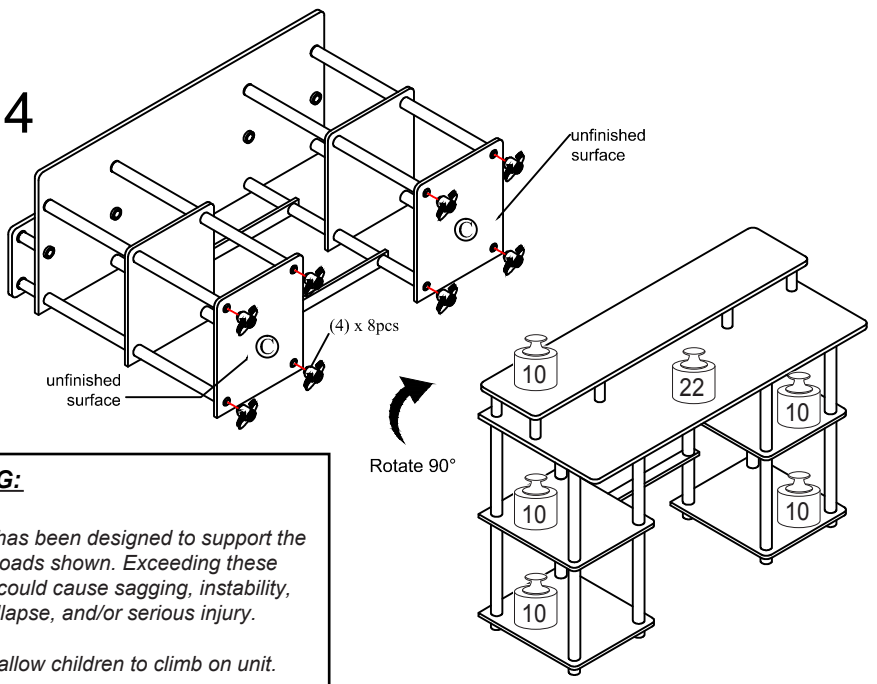

WARNING:

>This unit has been designed to support the maximum loads shown. Exceeding these load limits could cause sagging, instability, product collapse, and/or serious injury.

>DO NOT allow children to climb on unit.

Assembly Instruction

Furinno Turn-N-Tube Computer Desk with Top Shelf

00:30







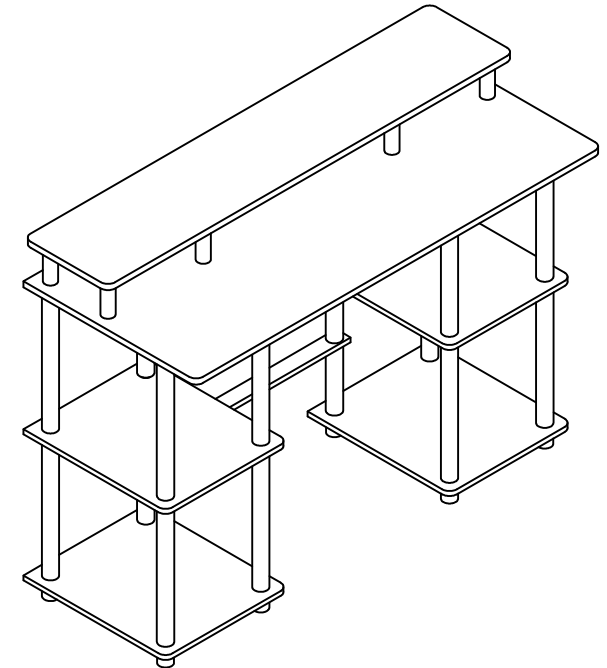

Approx. 30 minutes

Recomm. 1 Person

No Tools Required



HARDWARE & PART LIST

NO	PARTS LIST	QTY	NO	HARDWARE	QTY
A	LARGE TOP PANEL 	1pc	1	LONG ROUND POLE 	12pcs
B	SMALL TOP PANEL 	1pc	2	SHORT ROUND POLE 	8pcs
C	BOTTOM SHELF PANEL 	4pcs	3	EXTRA SHORT ROUND POLE 	8pcs
D	LONG CROSS BAR 	2pcs	4	ROUND LEG 	8pcs
			5	SMALL ROUND LEG 	4pcs

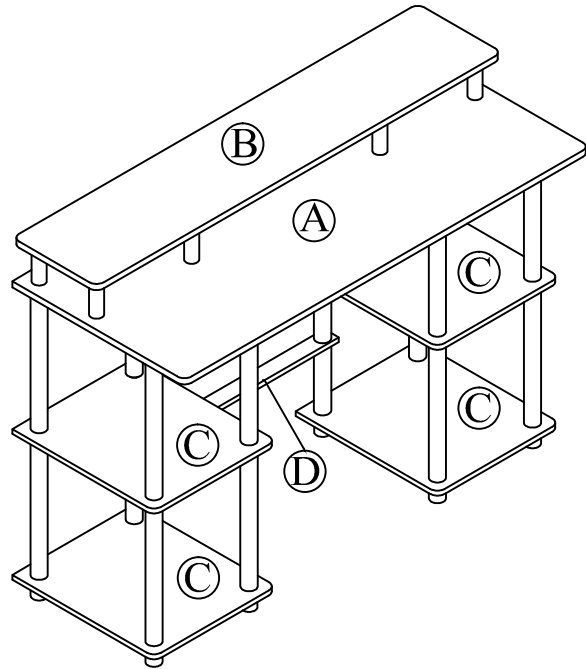

USEFUL HINTS BEFORE YOU START:

1. Read each step carefully before starting.
2. It is important that each step is performed in correct order to avoid difficulties.
3. Identify, sort and count the parts before assembly.
4. Assemble your furniture on packaging cardboard to prevent scratch or damage.
5. Clean the product with mild cleanser using soft damped cloth. Do not use harsh or abrasive cleanser.
6. Using incompatible hardware might cause damage to product.

ASSEMBLY INSTRUCTION

STEP 1

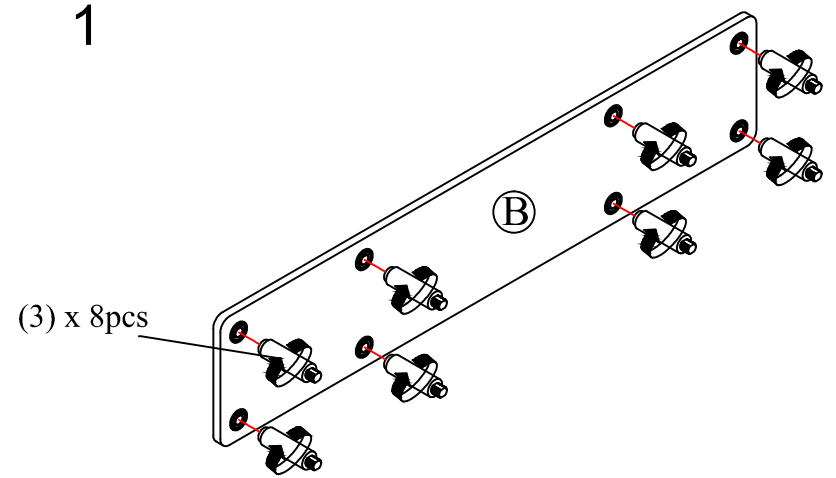

STEP 2

