

PRODUCT CARE HANDBOOK

a guide to protect your product



GuideTo Assembly

Thank you for purchasing this product. Please read these instructions fully before starting assembly, then follow the simple step by step guide.

TOP TIPS BEFORE YOU START!

1. Please check that all parts & hardware are present before you start the assembly of your furniture. Do not destroy any of the packaging until you are certain that you have all the necessary parts for assembly.
2. For ease and speed of assembly, we recommend that before you commence each step of the assembly, please identify all the parts required for that step.
3. We recommend that where possible, all items are assembled near to the area in which they will be placed in use, to avoid moving the product unnecessarily once assembled.
4. For the protection of your furniture, particularly items of high gloss finish, we recommend that the product is placed on a protected surface during assembly to prevent any damage.
5. During assembly please take care not to over-tighten any fittings, as this may damage the product.
6. Keep children and animals away from the work area, small parts could cause choking if swallowed.

Tools Required For Assembly



DO NOT USE POWER TOOLS TO ASSEMBLE THIS PRODUCT. USE OF POWER TOOLS WILL INVALIDATE ANY CLAIM AND MAY DAMAGE THIS PRODUCT MAKING IT UNSAFE.

Rubber Hammer



Self-provided general tool diagram:



Tape Measure

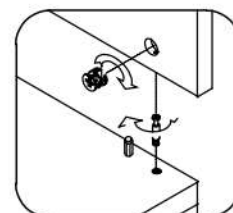
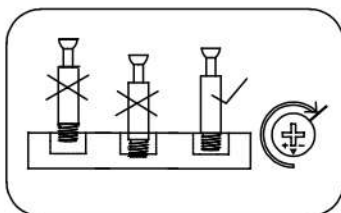

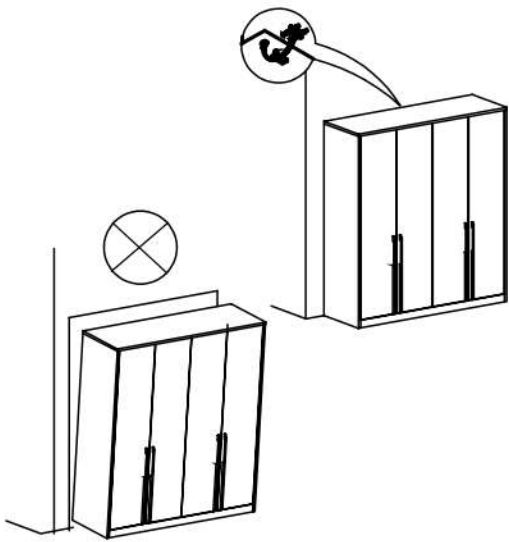

matters needing attention

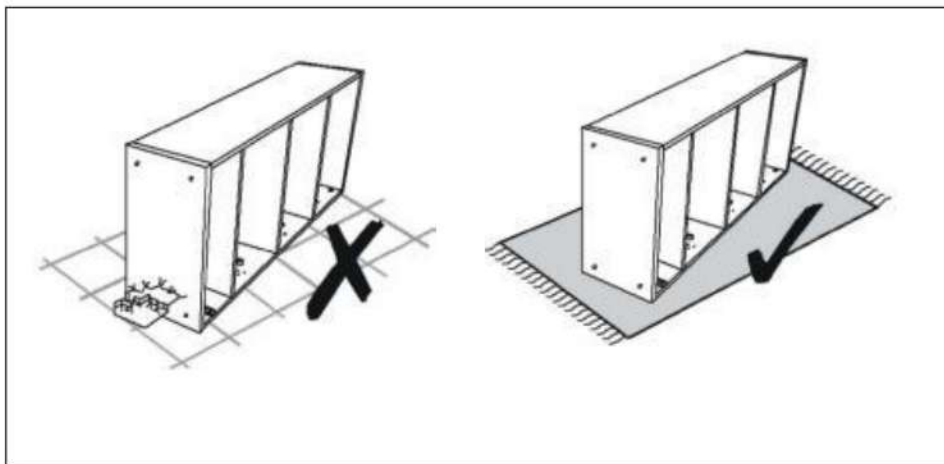
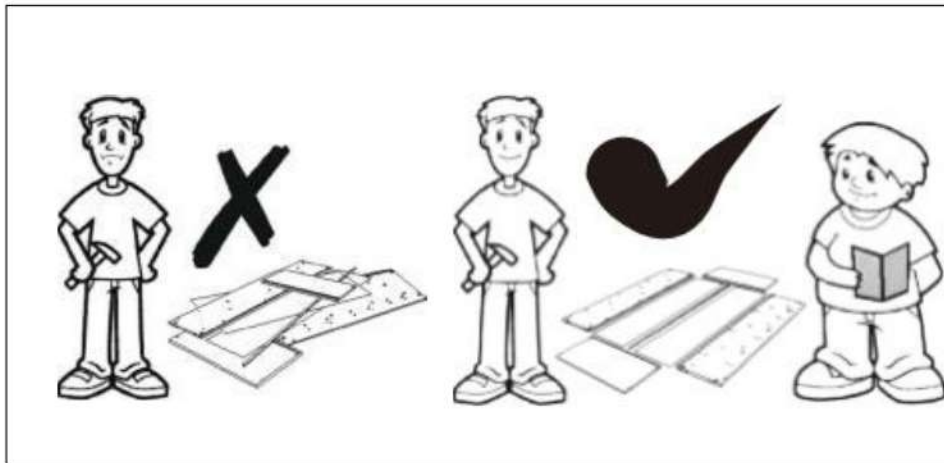

Installation Hardware

HA0059

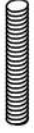



Double headed lead
screw M8*45

4PCS

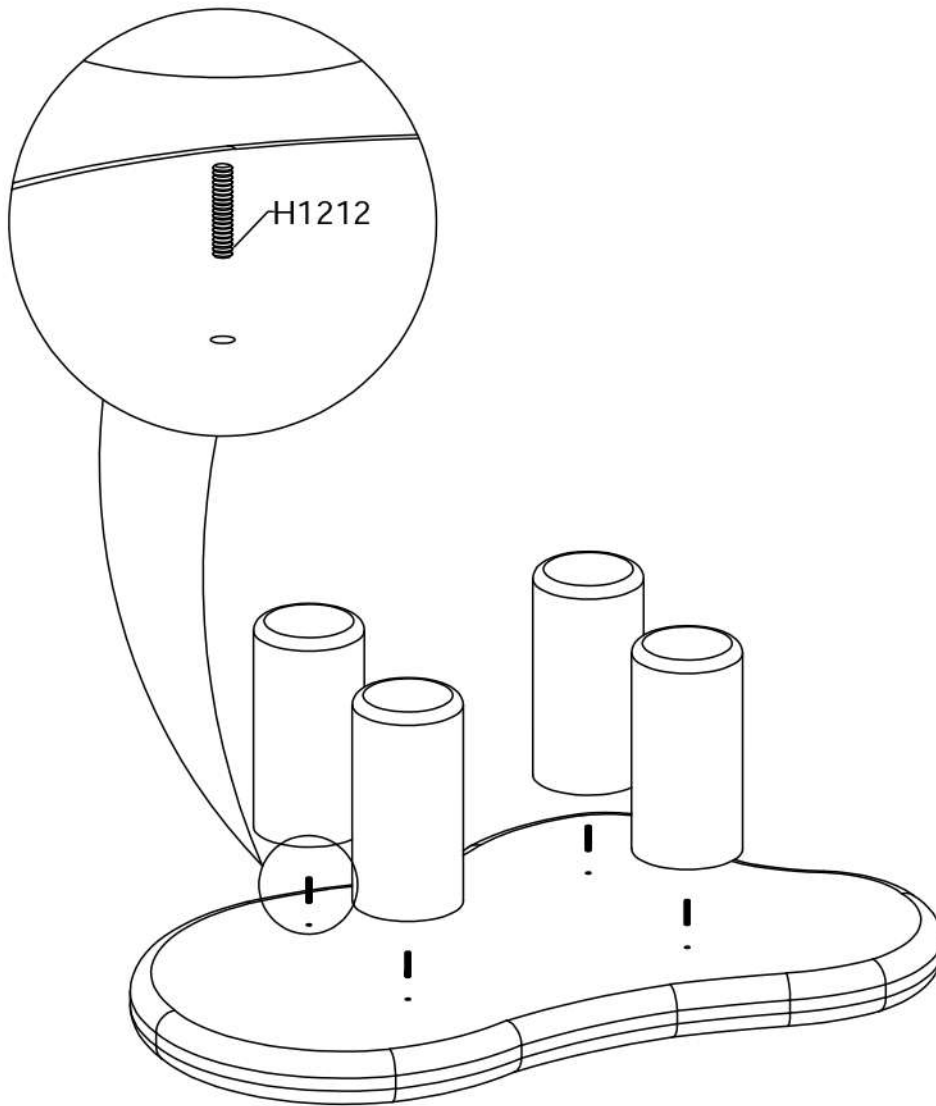
Installation Steps



After sales Hardware List

<p>HA0059</p>  <p>Double headed lead screw M8*45 4PCS</p>	<p>H2543</p>  <p>φ15 Anti slip pads 4PCS</p>	<p>H1325</p>  <p>Inner and outer threaded nuts (with intermediate) M8*25 4PCS</p>	
--	---	---	--

List of After Sales Parts

B01*1 countertop

B02*4 legs

