

PRODUCT ASSEMBLY INSTRUCTIONS

【 Product Model: FS137-1067 】

List :

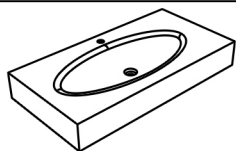

Solid Surface Bathroom Sink x1

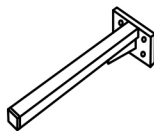

Support x2



Expansion Bolt x8

Tools Required :

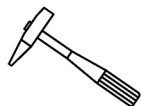

A

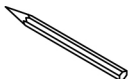

B

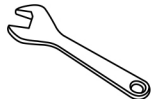

C



D

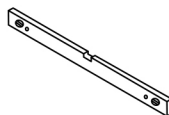

E



F

A Hammer

B Pencil

C Wrench

D Electrodrill

E Gradienter

F Steel tape

Installation Steps : 1

Measure the distance of the mounting holes, and the height you want, mark with the pencil.

(33"-36" is preferred for countertop height).

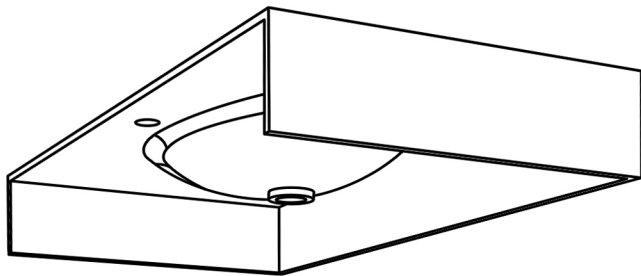

【 The back of the product 】

Installation Steps : 2

Drill the hole at the mark with electric drill.

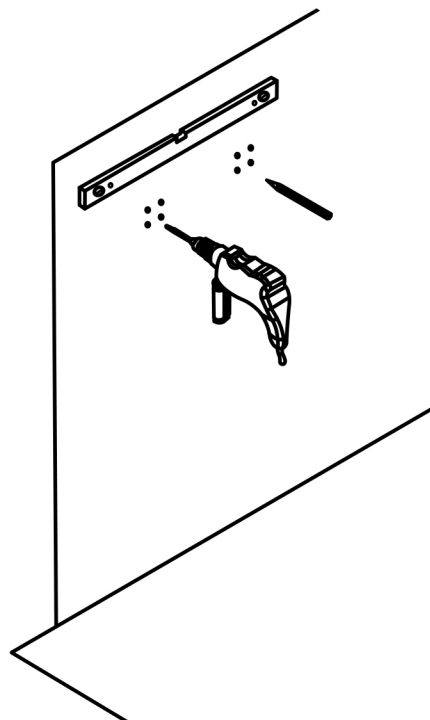

Installation Steps : 3

Insert the wall plug and mount screws into the wall. Install the brackets. Put some glue on the surface of brackets.

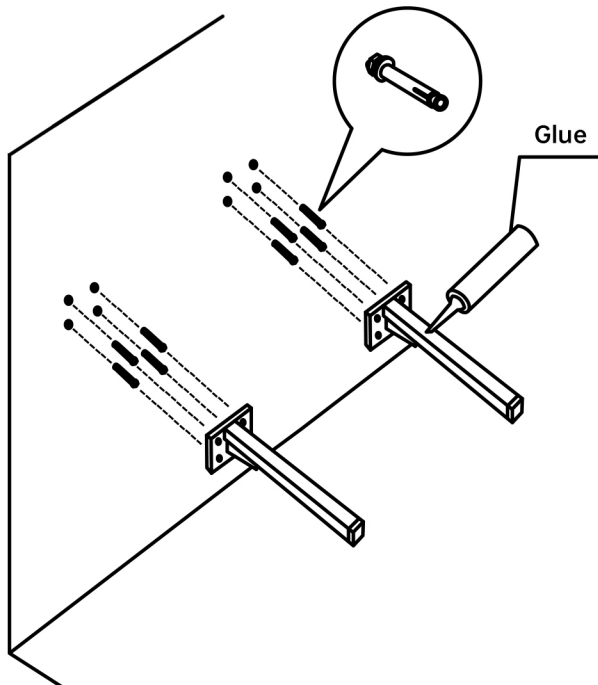

Installation Steps : 4

Install the product onto the stand.

⚠ Before installing your bathroom sink, make sure the brackets are secure.

