





# ASSEMBLY INSTRUCTIONS



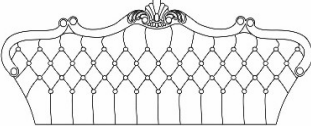
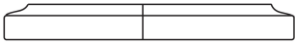

ITEM NO# 3025-S

DESCRIPTION: SOFA

**Caution:** Please read instructions thoroughly before unpacking assembly parts, Sharp, exposed staple tips can cause injury, therefore, for your protection, please remove any exposed staple used in packing.

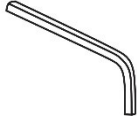
1. We recommend that you should assemble this product with the assistance of another person; this will make assembly easier, and will help to eliminate damage to the product or injury to persons during assembly.
2. Be sure to check all packing materials carefully for small parts that may have come loose inside the carton during shipment.
3. Please do not over tighten screws or bolts
4. Please put all parts on a non-abrasive floor before assembly, and follow the assembly steps to assemble your newly purchased product correctly and efficiently

PART LISTS			
No.	Desc.	Sketch	Qty (PCS)
A	SEAT FRAME		1
B	LEFT ARM		1
C	RIGHT ARM		1
D	BACKREST		1
E	SEAT CUSHION		2
F	LEG		4
G	CENTER LEG		1

HARDWARE LISTS				
No.	Desc.	Sketch	Size	Qty (PCS)
1	ALLEN KEY		Ø5/16"	1
2	BOLT		Ø5/16"x2 1/2"	15
3	FLAT WASHER		Ø5/16"x7/8"	15
4	WASHER		Ø5/16"x1/2"	15

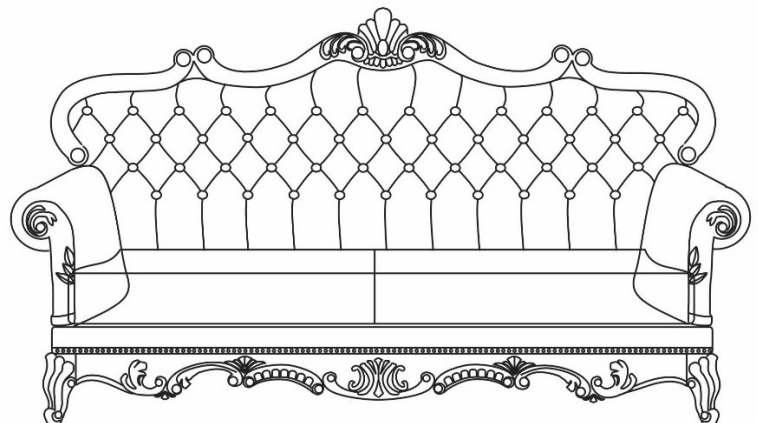

# ASSEMBLY INSTRUCTIONS

ITEM NO# 3025-S

DESCRIPTION: SOFA

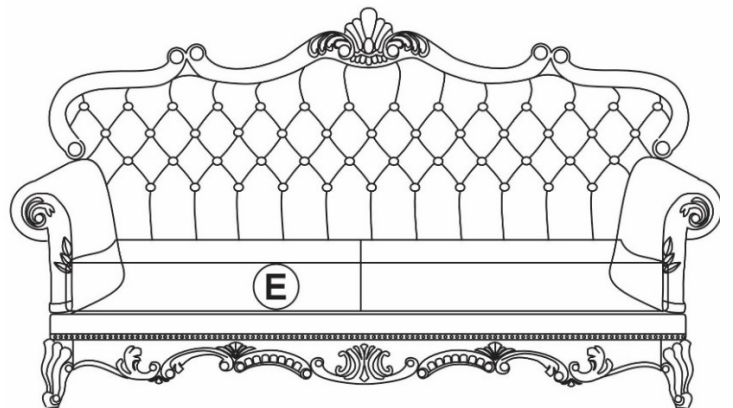
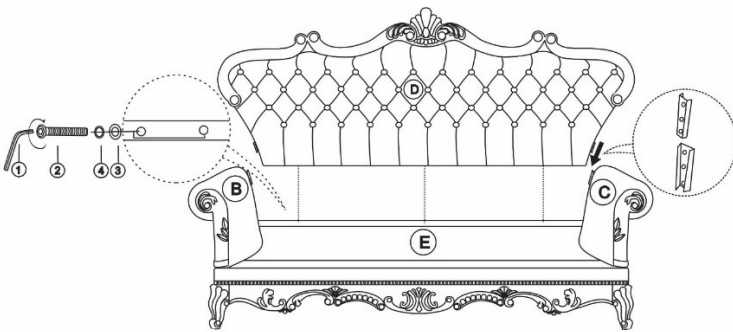
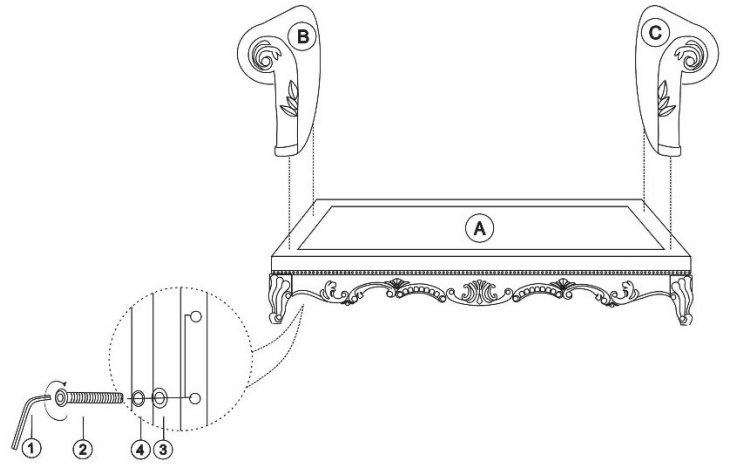
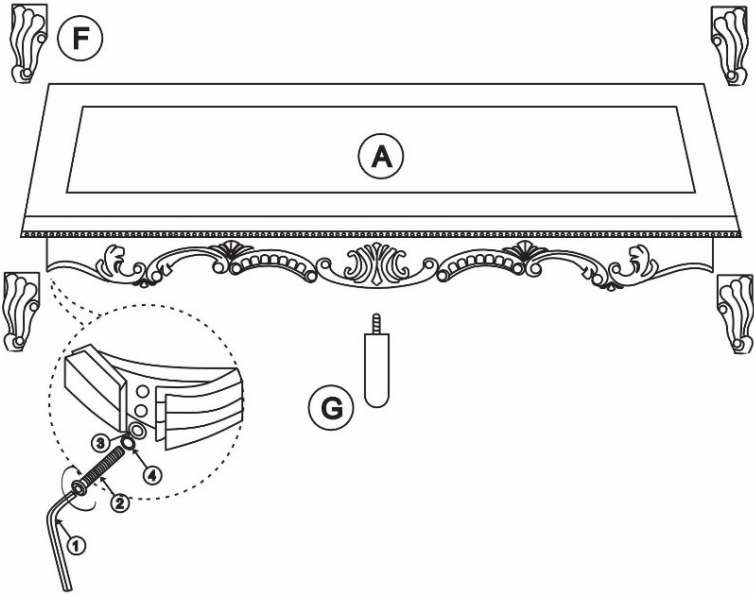

**ASSEMBLE COMPLETED**