

# ASSEMBLY INSTRUCTIONS

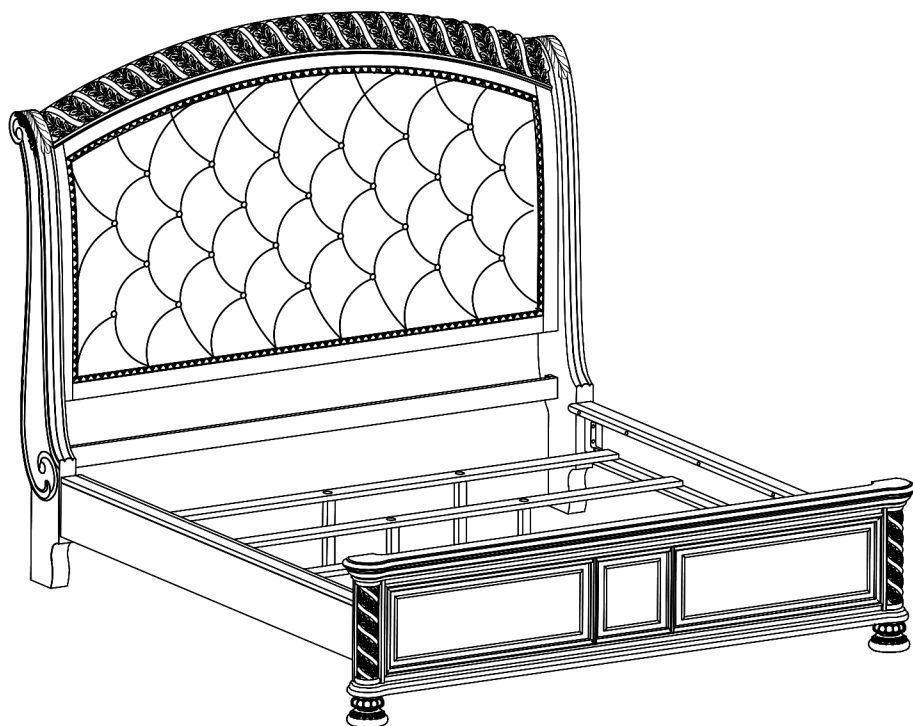

## TOOLS REQUIRED



Allen Wrench

(Included)



Phillips  
Screwdriver

(Not Included)

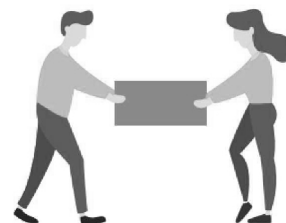

2 - People  
Recommended

## ASSEMBLY RATING



EASY —————> DIFFICULT

The Assembly Rating is a 5-point system showing the level of effort needed to assemble a specific product.



## **CHECK BEFORE STARTING**

### **Are you missing anything?**

Double-check all parts, hardware and accessories listed are all accounted for.

### **Should we send any replacements?**

Are there any irregularities or flaws in the parts? We can send replacements!

### **Check out our Quick Tips!**

We recommend reviewing the pre-assembly handouts. Even experts need a refresher now and then!

### **Prep Time!**

Please review the assembly instructions and all diagrams prior to assembling.

# PRE ASSEMBLY INTRODUCTION

We understand building ready-to-assemble furniture can be a challenging experience for some. To help avoid confusion, we have provided some helpful tips that may speed up the process.

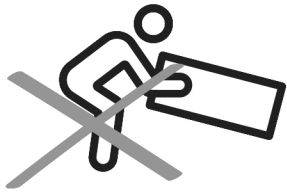

## Teamwork

ALWAYS have at least two people to help with transporting and assembling the product to avoid potential injury and/or damage.

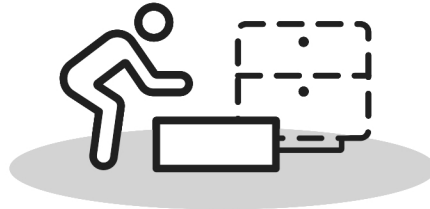
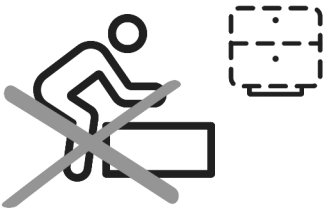

## Suitable Location

Assembling near the area of the intended location is highly recommended.



## Sufficient Space

Make sure you have enough space to move around during the assembly.

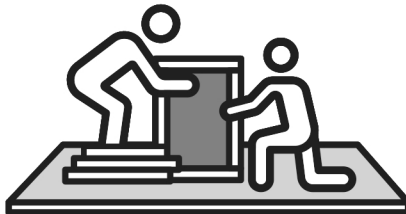

## Avoid Scratches

Use cardboard, blankets or a carpeted area while assembling furniture to prevent to prevent scratches and damages.

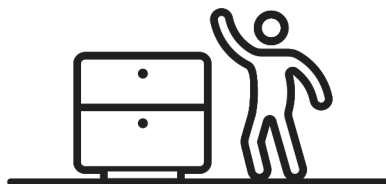
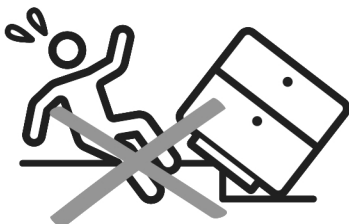

## Flat Surface

Make sure the furniture rests on a flat and level surface with each leg evenly touching the floor.

# ASSEMBLY AND CARE ADVICE



**FAILURE TO FOLLOW THE GUIDELINES BELOW MAY RESULT IN INJURY AND/OR PROPERTY DAMAGE.**



Position each part correctly and insert screws or bolts into their respective holes.

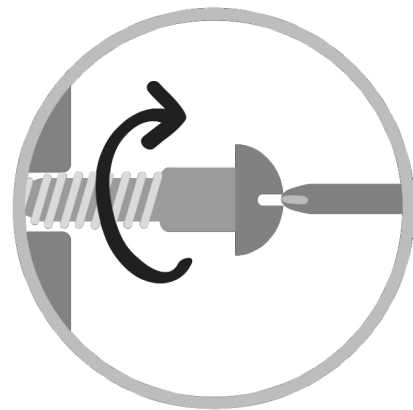

Turn clockwise to tighten and only tighten when step is completed or when instructed to do so.



Use the appropriate hand tools or power tools for assembly. Select steps, such as tightening screws and/or bolts, may require hand tools to avoid causing damage during assembly.



Save the instructions and store any supplied tools for later maintenance.

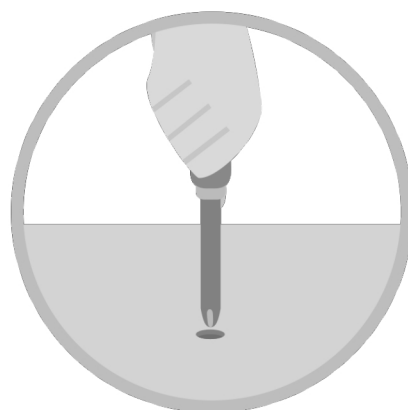

After two weeks, check and tighten any loose hardware and repeat again every six months thereafter.

**IT IS THE USER'S RESPONSIBILITY TO MAINTAIN THE FURNITURE. THE HARDWARE MAY LOOSEN OVER TIME AND MAY CAUSE THE FURNITURE TO BE WOBBLY AND UNABLE TO SUPPORT ITS INTENDED WEIGHT CAPACITY. THIS MAY LEAD TO COLLAPSE AND MAY CAUSE SERIOUS INJURY.**

# BED

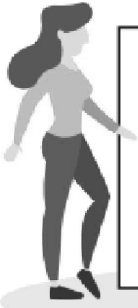

- Please keep instructions for future reference.
- Check the quantity and irregularity of parts and hardware before you start.

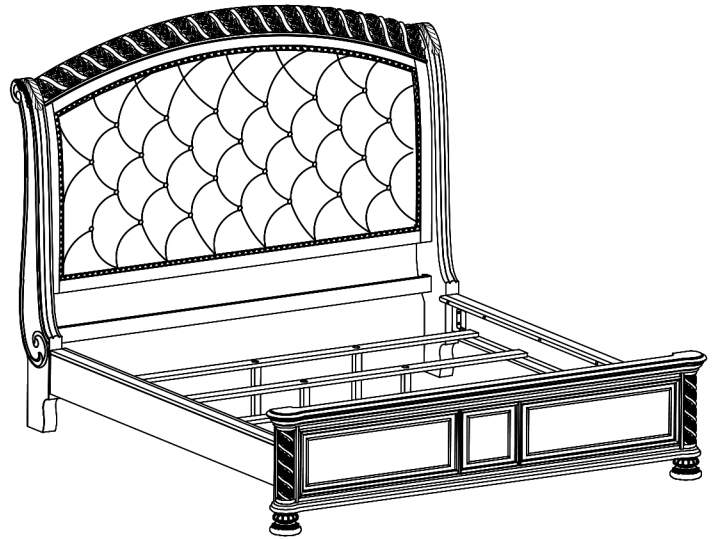

## PARTS

#1 1pc

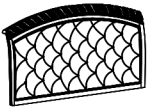

Headboard

#2 2pcs



HB Leg (R/ L)

#3 1pc



HB Support Rail

#4 1pc



Footboard

#5 2pcs



FB Leg

#6 2pcs



Side Rail

#7 4pcs

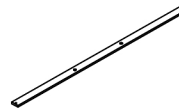

Slat

#8 8pcs



Support Leg  
230\*30\*30

## HARDWARE

#A 6pcs

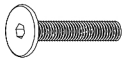

Bolt  
Ø5/16" x 2-1/4"

#B 4pcs

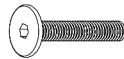

Bolt  
Ø5/16" x 1-3/4"

#C 10pcs



Lock washer  
Ø5/16"

#D 10pcs



Flat washer  
Ø5/16"

#E 1pc



Allen wrench  
5mm

#F 2pcs



Threaded Stud  
Ø5/16"x2-3/4"

#G 8pcs



Threaded Stud  
Ø5/16"x3-1/2"

#H 8pcs



Hex Nut  
Ø5/16"

#K 1pc

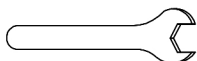

Wrench  
12mm

#L 8pcs

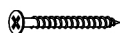





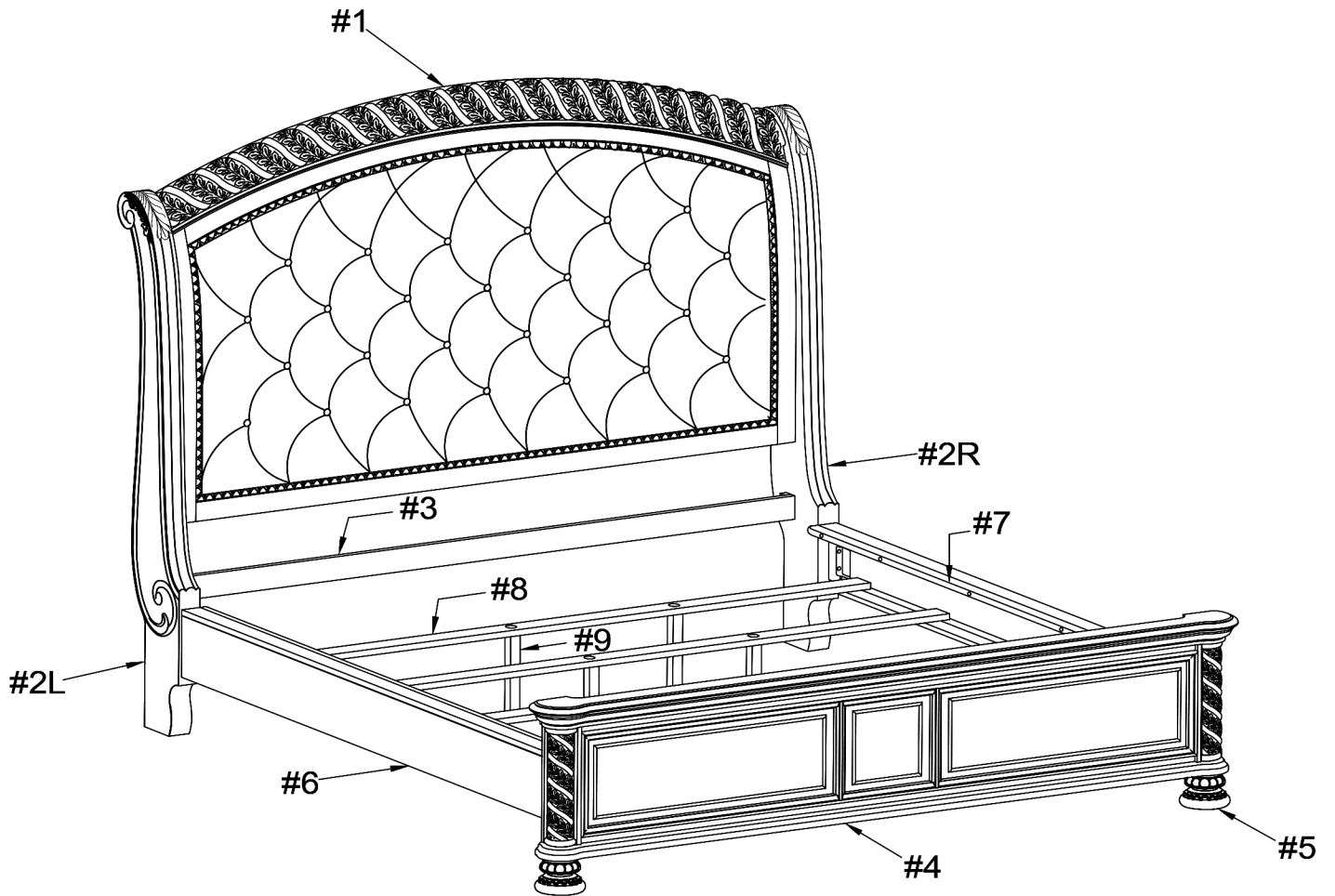



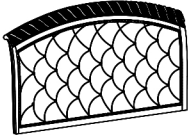



Screw  
#8 x 30mm

# Exploded View

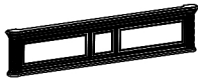

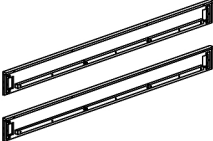
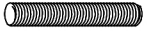
# packed in 3 cases

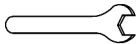
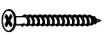
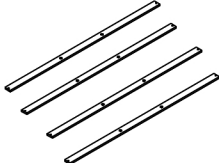
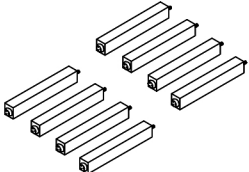
Carton	Disignation	Part		Hardware
	Headboard	#1		 #A 6pcs  #B 4pcs  #C 10pcs  #D 10pcs  #E 1pc
	HB Leg (R/ L) (2pcs)	#2		
	HB Support Rail	#3		
	Footboard	#4		 #F 2pcs
	FB Leg (2pcs)	#5		
	Side Rail (2pcs)	#6		 #G 8pcs  #H 8pcs  #K 1pc  #L 8pcs
	Slat (4pcs)	#7		
	Support Leg (8pcs)	#8		

# ASSEMBLY INSTRUCTIONS

## 1

- Part #1 x1pc
- Part #2 x2pcs
- Part #3 x1pc
- Hardware #A x6pcs
- Hardware #B x4pcs
- Hardware #C x10pcs
- Hardware #D x10pcs

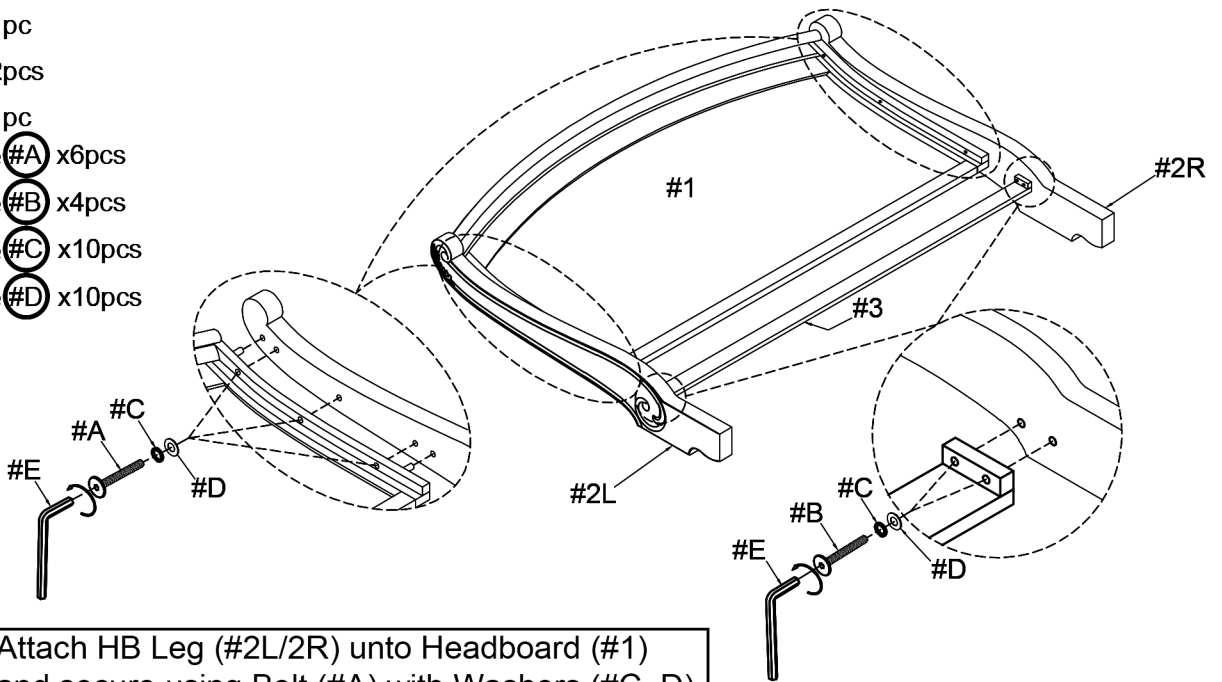

Attach HB Leg (#2L/2R) unto Headboard (#1) and secure using Bolt (#A) with Washers (#C, D). Next, attach HB Support Rail (#3) and secure using Bolt (#B) with Washers (#C, D)

## 2

- Part #4 x1pc
- Part #5 x2pcs
- Hardware #F x2pcs

Attach FB Leg (#5) to Footboard (#4) and secure using Threaded Stud (#F)

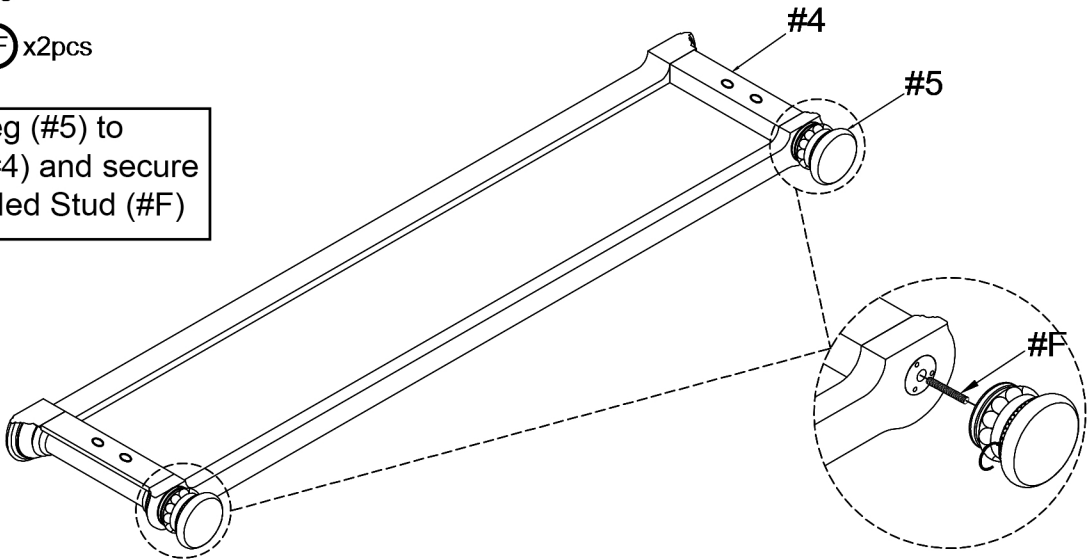

# ASSEMBLY INSTRUCTIONS

## 3

- Part #6 x2pcs
- Hardware #G x8pcs
- Hardware #H x8pcs

Align and attach Side Rail (#6) using Threaded Stud (#G) and Hex Nut (#H)

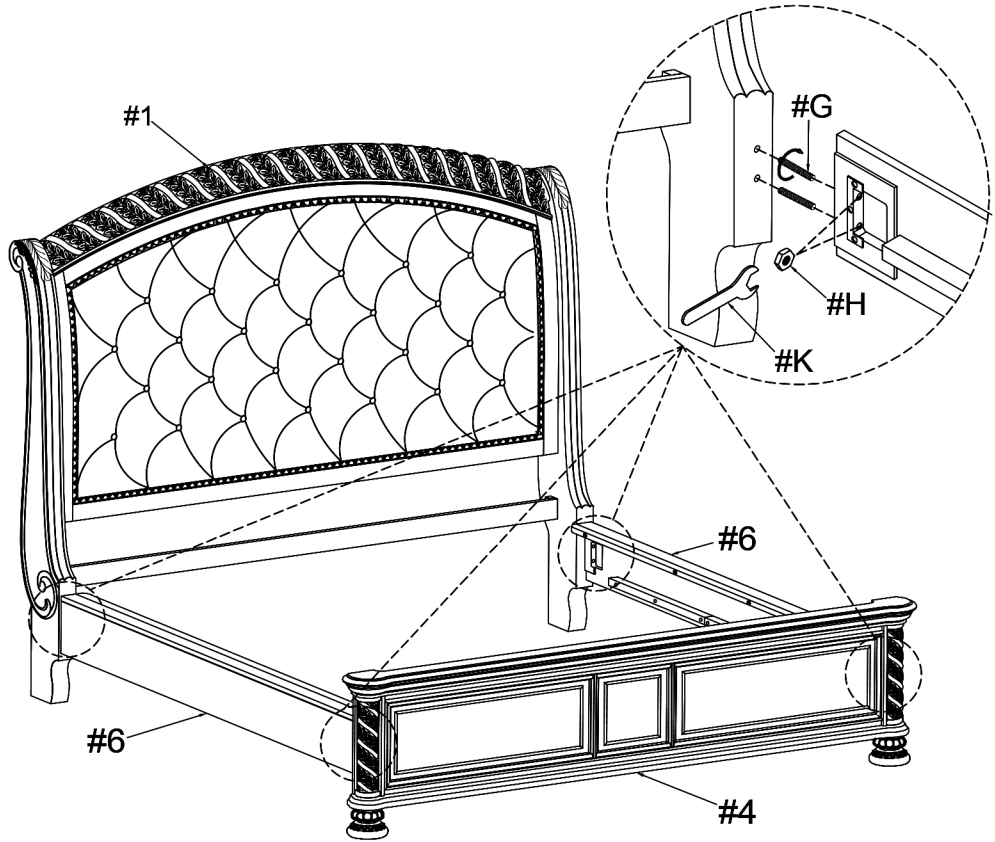

## 4

- Part #7 x1pc
- Part #8 x2pcs

Insert Support Leg (#8) unto Slat (#7)

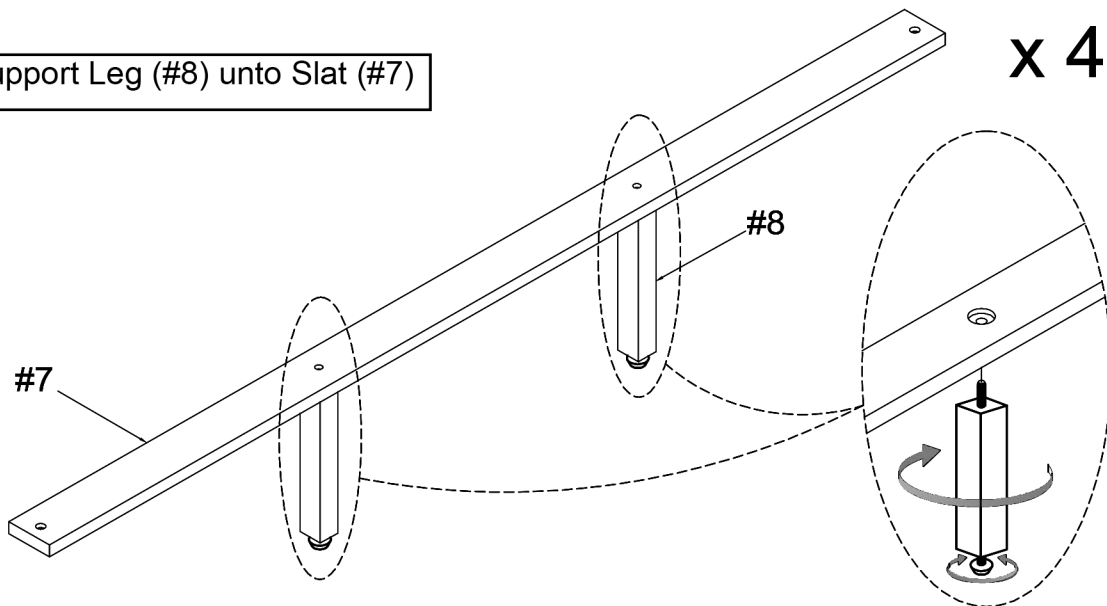

# ASSEMBLY INSTRUCTIONS

## 5

Hardware (#L) x8pcs

Secure Slat (#7)  
using Screw (#L)

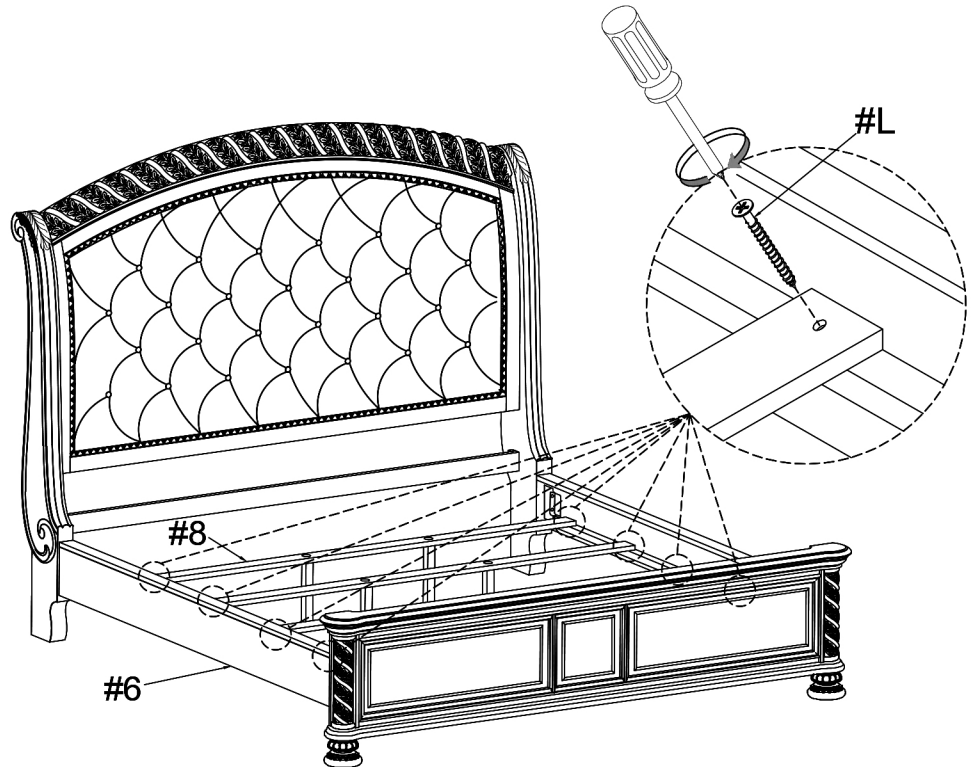

## 6

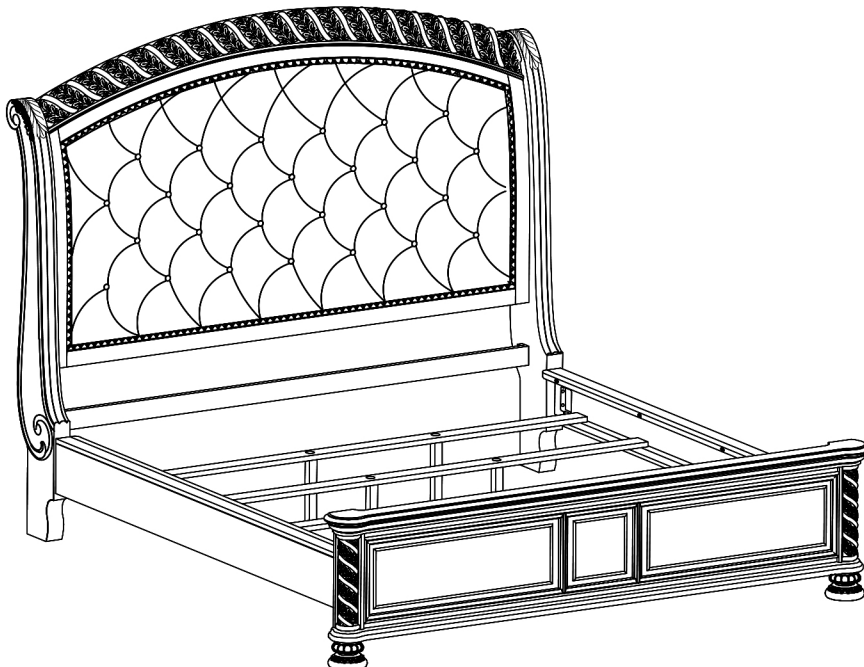

### ASSEMBLY COMPLETED



Please ensure the furniture rests on an even and flat surface. If the product wobbles or feels loose, double-check all bolts and/or screws are properly tightened and secured.



#### Keep this handy!

Please retain this instruction manual and any order-related information for future reference.



#### Lift, don't drag!

To avoid damage to product please always LIFT the product when transporting or adjusting the placement.