











(1) *1		(2) *1	
(3) *1		(4) *1	
(5L) *1		(6R) *1	
(7L/7R) *1		(A) *4	M6*16 
(B) *22	M6*12 	(C) *4	M6*20 
(D) *1			

It's best to have two people assemble it



3

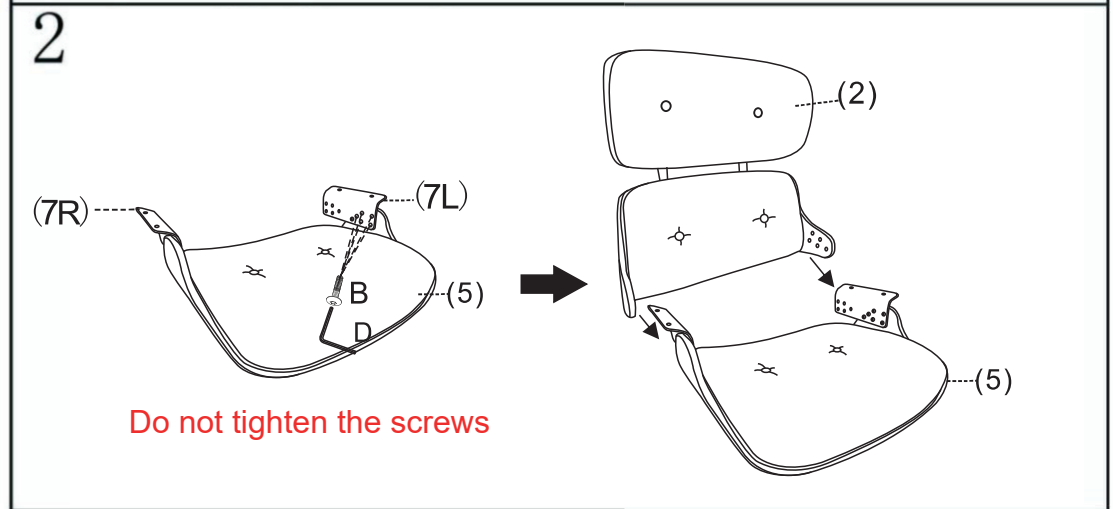
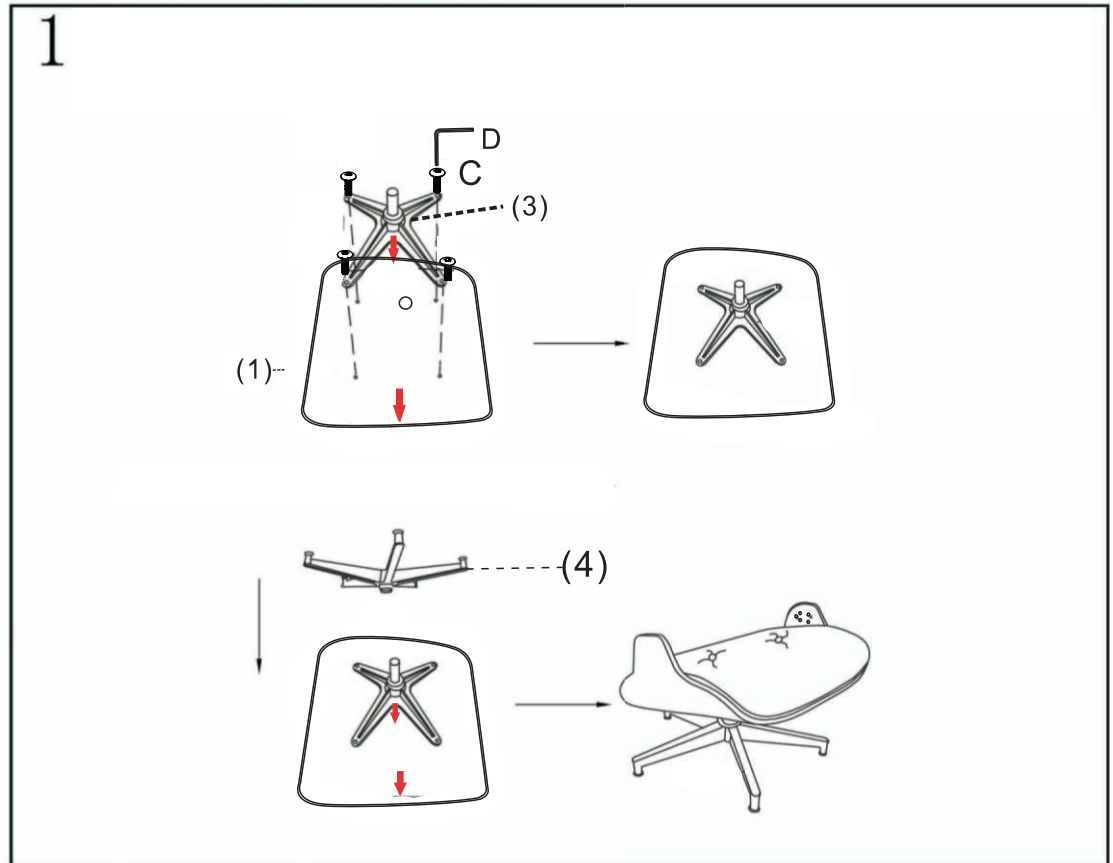
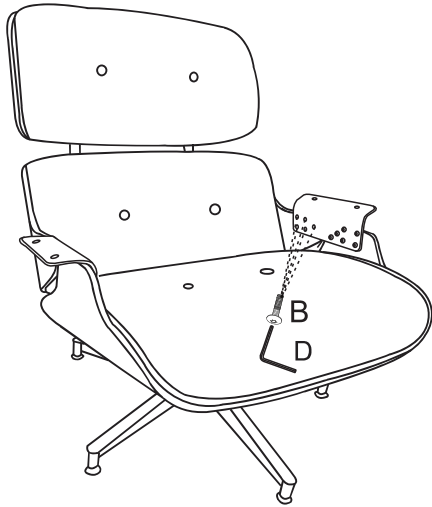

Tighten all screws

4

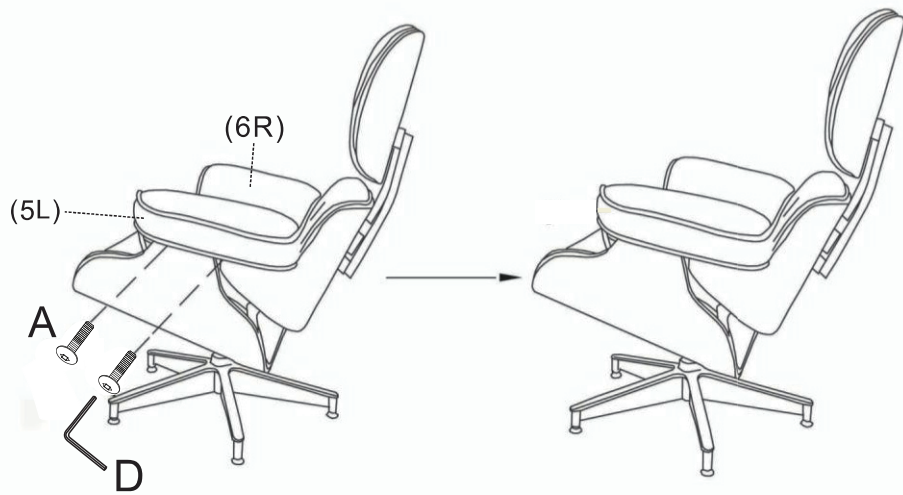

5

