







Assembly Instruction

⚠ WARNING:

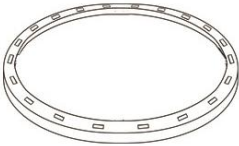
- Read all instructions carefully and completely before assembly and use. Retain for future reference.
- Periodically check all hardware and re-tighten as necessary.
- For residential (non-commercial) use only.
- DO NOT sit or stand on product. Use only for intended purpose.
- DO NOT exceed 30lbs for the tabletop, evenly distributed.

Parts List

Check all parts before assembly

| | | |
|---|---|--|
| <p>A. <u>Table Top</u></p>  <p>X1</p> | <p>B. <u>Leg</u></p>  <p>X20</p> | <p>C. <u>Bottom</u></p>  <p>X1</p> |
| <p>D. <u>Screw</u></p>  <p>X8 (+1)</p> | <p>E. <u>Foot pad</u></p>  <p>X4</p> | <p>F. <u>Alley Key</u></p>  <p>X1</p> |

Step1: Put the tabletop (A) on a soft surface to protect the finish.

Insert the Legs (B) to the Table Top (A) as below left photo shown. After all Legs (B) inserted, attached the Bottom (C) with the Legs. Ensure all Legs insert well with the Bottom (C) and Table Top (A) .

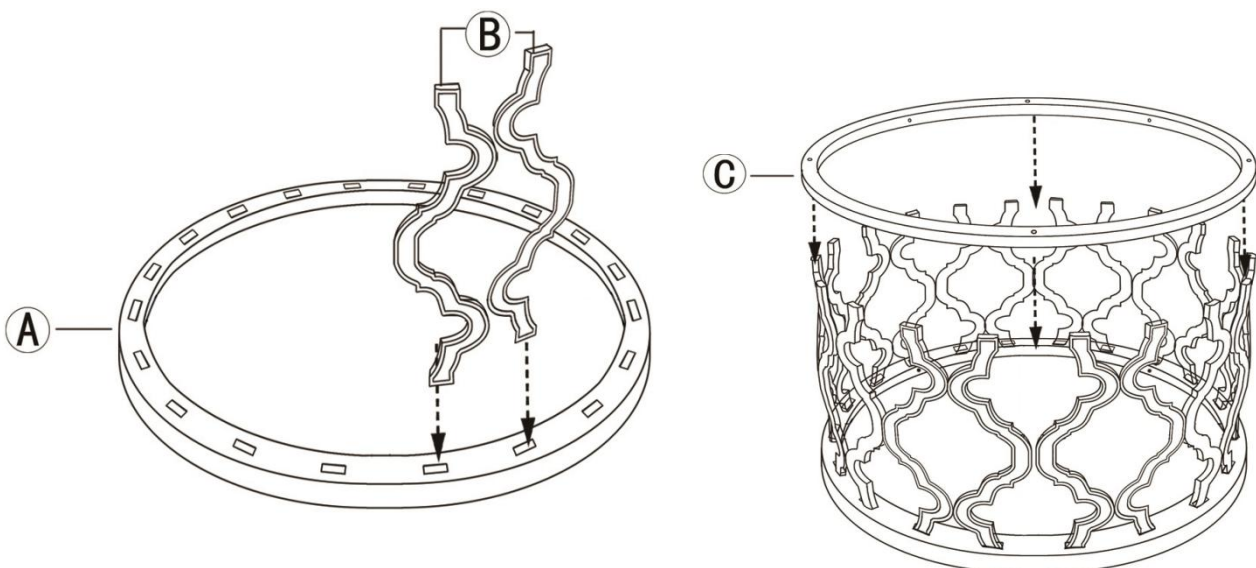

Step 2: Before you start this step, please ensure all Legs insert well with the Bottom (C) and Table Top (A). Attached the Screw (D) to the holes on Bottom (C) & Table Top (A) by Allen Key (F) as below left photo shown. Attach the Foot pads (E) to bottom as below right photo shown.

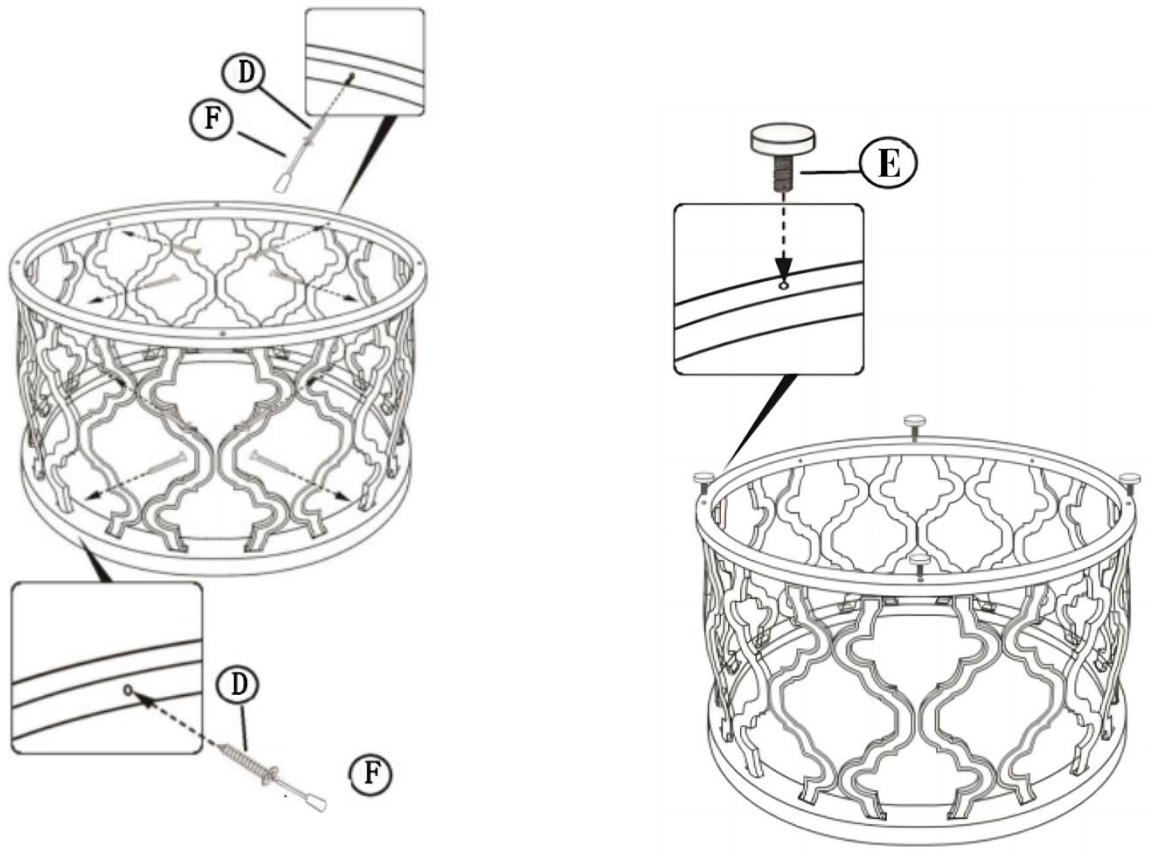

Assembly Finished.

