

Operating Instructions

Caution: You must read this before you proceed

Barstool

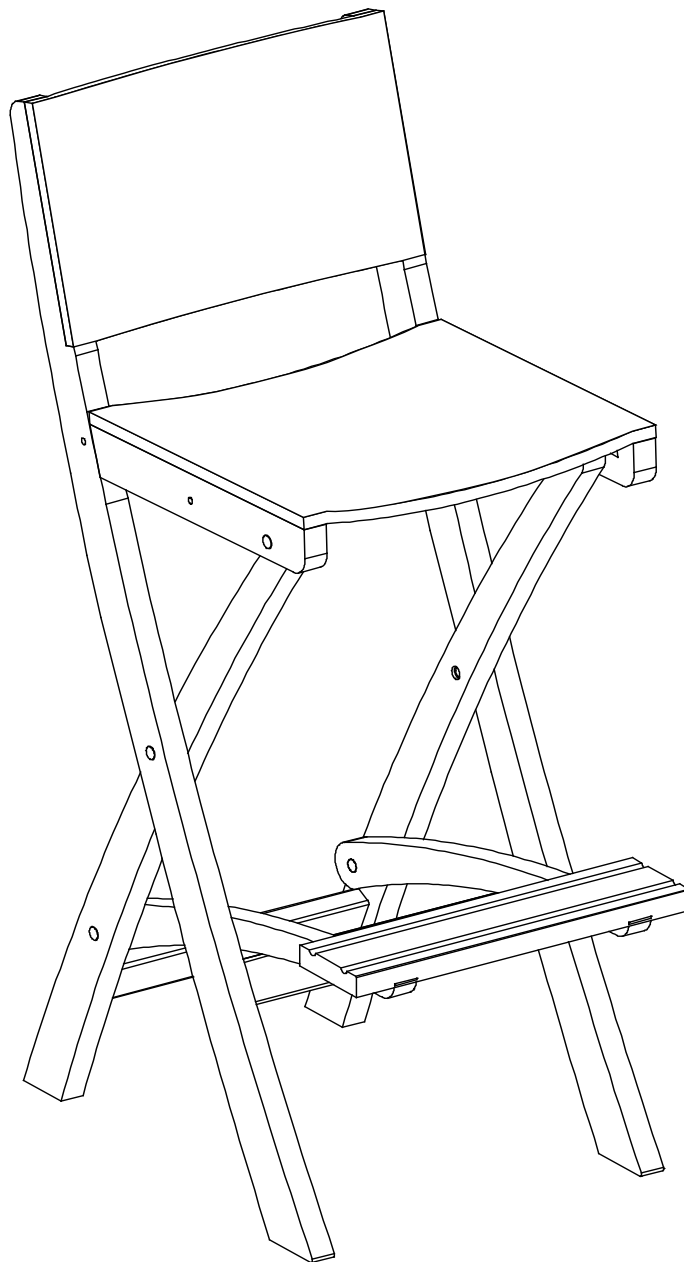

CAUTION : This Barstool is NOT a TOY.
Keep your child/children at bay when opening or folding the Barstool.

Operating Instructions

Step 1

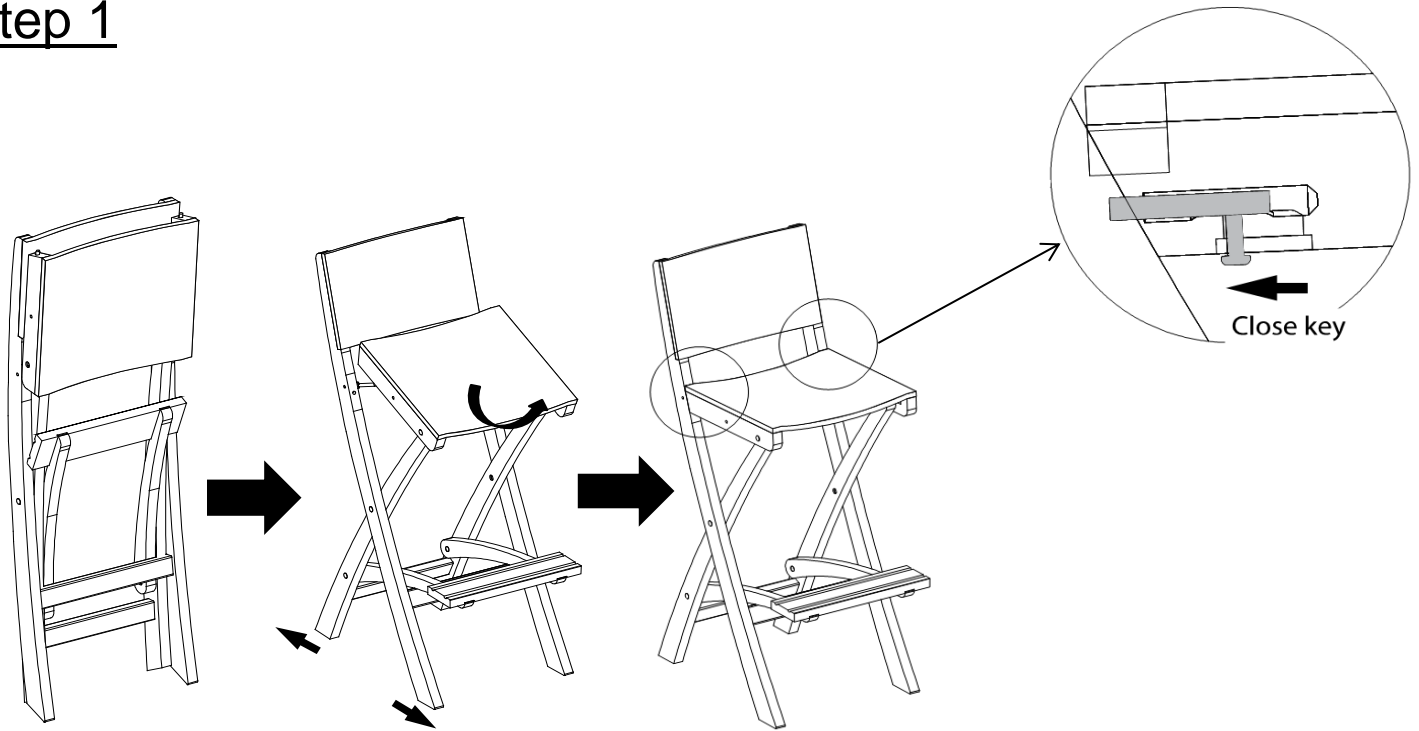

Position the Barstool as pictured.

To open:

Pull the Seat forward with one hand and steady the Barstool with your other hand. Unfold Leg Frame as indicated by the arrows, until the Barstool folds out and locks into position.

Note: There is a iron latch under the Seat Frame, pull this up by hand to lock/unlock the iron dowel into positon.

Step 2

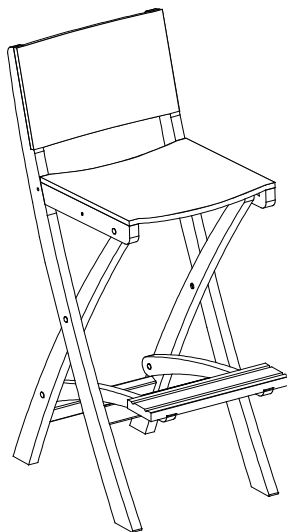

Your Barstool is ready for use.

This Barstool can only be used on a flat, level surface.

Step 3

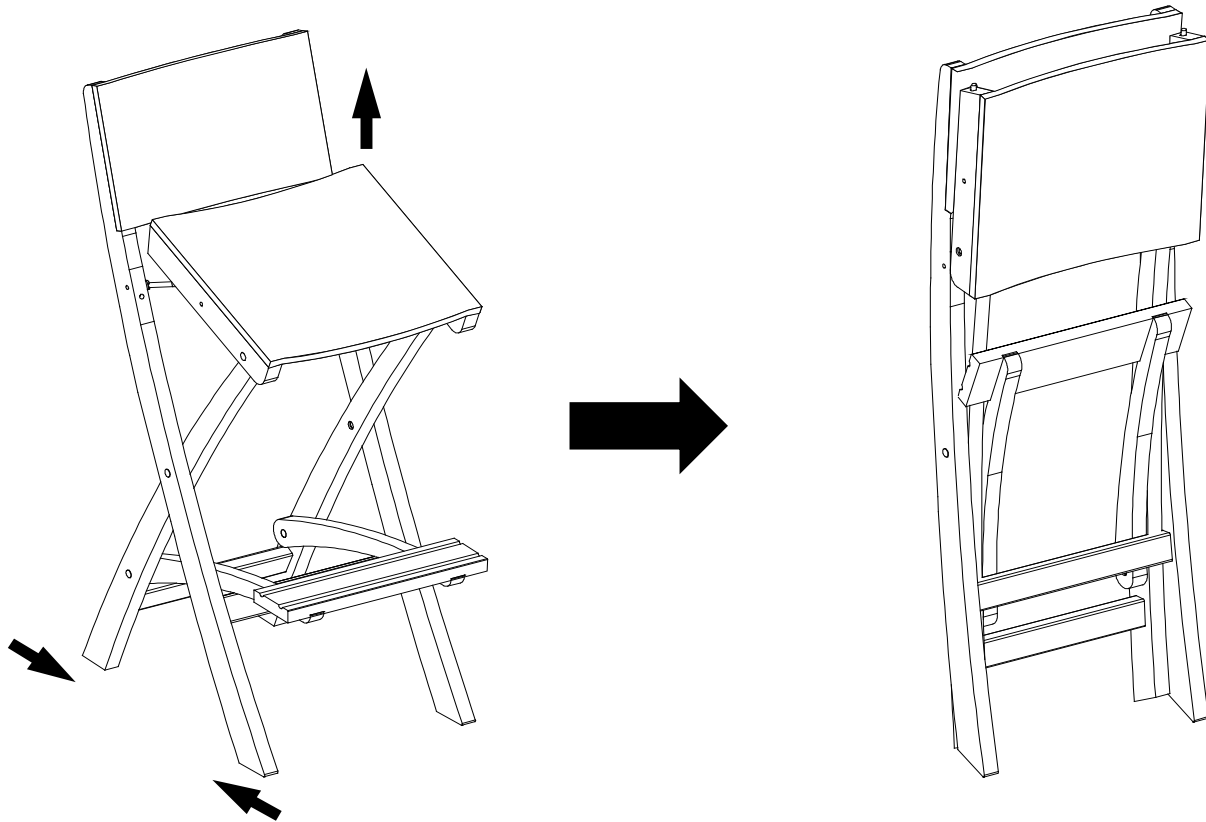
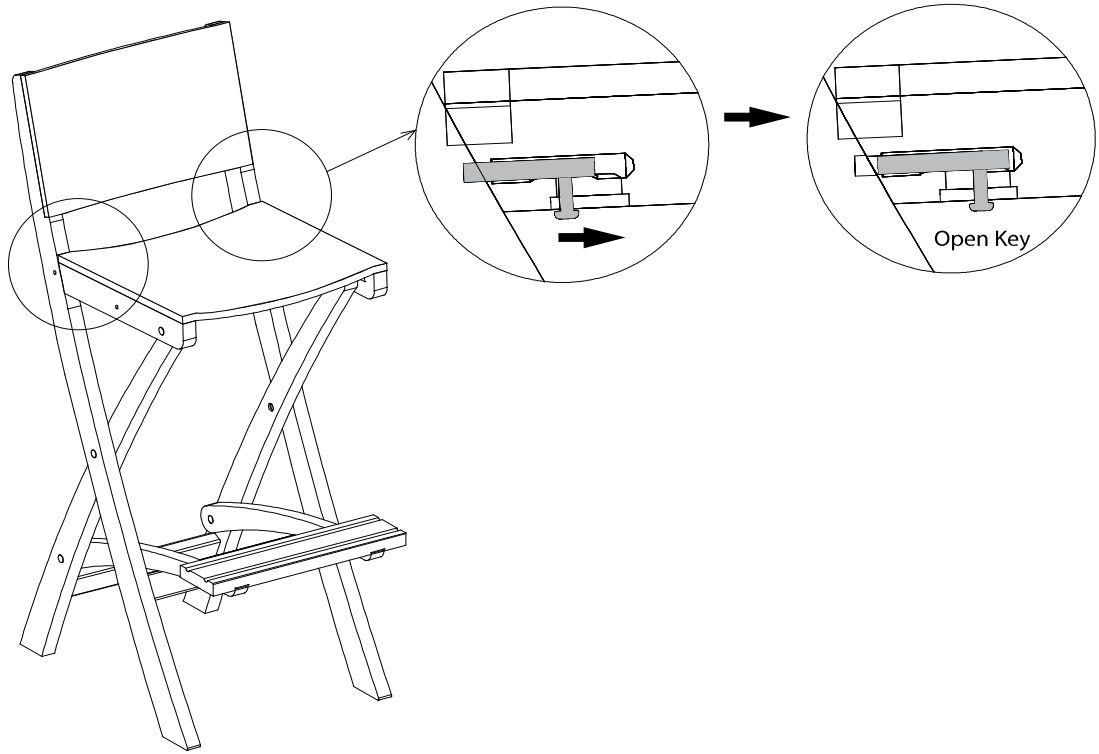





















To close:

Pull the Seat up and fold Iron Leg Frame as indicated by the arrows, by hand, until the Barstool folds shut.

Note: There is a iron latch under the Seat Frame, pull this up by hand to lock/unlock the iron dowel into positon.

Care & Maintenance

-   ● Do not put hot items directly on furniture surface
 -   ● Do not clean furniture with harsh cleansers or polish.
 -   ● To obtain the longest lifespan of your outdoor products, minimizing exposure to direct sunlight is recommended.
 -   ● Children should not climb or jump on the furniture.
 -   ● Do not write on furniture without a padded barrier to protect the surface.
 -   ● To obtain the longest lifespan of your outdoor products, avoid extended and lengthy exposure to rain, snow, and direct sunshine. Whenever possible cover the product and /or place under patio or awnings.
 -   ● Not for commercial use. For residential use only .
 -   ● Stains may be removed with mild soap solution and damp cloth.
 -   ● Keep away from sources of ignition.
-
-   ● Dust and pick-up spills using a clean, non-colored, lint-free cloth.