

# ASSEMBLY INSTRUCTIONS

## CARMEN SQUARE DINING TABLE

ASSEMBLY  
REQUIREMENTS

2-PERSON  
ASSEMBLY

45 MINUTES  
ASSEMBLY TIME

TOOLS REQUIRED  
(NOT PROVIDED)

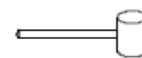

MALLET

### Thank you for purchasing our product!

Please refer and use this assembly instruction to assemble the product. Contact our customer service department in case there are any missing or damage parts or hardware. Replacement parts are normally shipped within 2 or 3 days

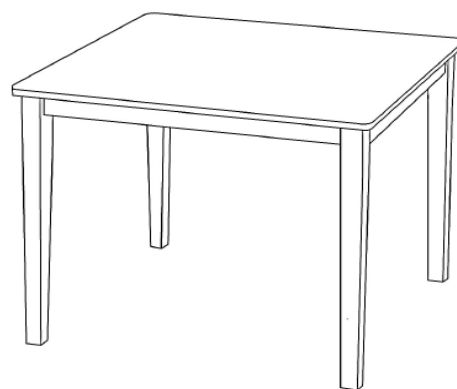

**We appreciate your business!**

### ASSEMBLY PREPARATION

1. Remove all packing materials, staples and packing straps from the carton.
2. Refer to Parts List and Hardware List, and ensure all the parts and hardware are correct before assembly.
3. Contact customer service for missing part.

### SAFETY PRECAUTION

1. KEEP ALL HARDWARE PARTS OUT OF REACH OF CHILDREN.
2. DISPOSE PLASTIC PACKAGING MATERIAL IMMEDIATELY TO AVOID ANY RISK OF SUFFOCATION TO CHILDREN AND ANIMALS.

### TIPS FOR ASSEMBLY

1. Allow ample room for assembly and in close proximity to where product will be placed.
2. Assemble the product on a surface that does not scratch or damage the exterior gloss and finish of the furniture.
3. Identify all of the parts, hardware and quantities required for each step.
4. During assembly, do not over-tighten any fittings as this may cause damage.
5. DO NOT USE POWER TOOLS TO ASSEMBLE THIS PRODUCT.
6. Always place the product on a flat, level surface.
7. Do not sit or stand on the partially assembled product; only use the product for which it is intended.

### CARE AND MAINTANANCE

- Use a slightly damp cloth to clean the product. Do not use bleach or abrasive cleaning material.
- Check all the fittings periodically and re-tighten as necessary. Do not use the product if any of the parts is damaged or broken.
- Never allow any kind of liquid to remain on your furniture. Absorption can cause wood to warp or delaminate.
- Do not place hot items (e.g. hot drinks) directly onto the wood surface.
- Do not drag and/or pull the furniture.

This product is for indoor and household use only – not for commercial use.





# ASSEMBLY INSTRUCTIONS

## CARMEN SQUARE DINING

### PARTS LIST (FOR 1 TABLE)

NO.	COMPONENT	QTY.
P1	TABLE TOP	1
P2	TABLE LEG	4

### HARDWARE LIST (FOR 1 TABLE)

NO.	DESCRIPTION	QTY.	EXTRA
H1	ALLEN KEY 	1	
H2	JCBB SCREW M8X60 	8	1
H3	SPRING WASHER 	8	2
H4	FLAT WASHER 	8	2
H5	LEG STUD 	4	2

\* Extra Hardware For Spare Use

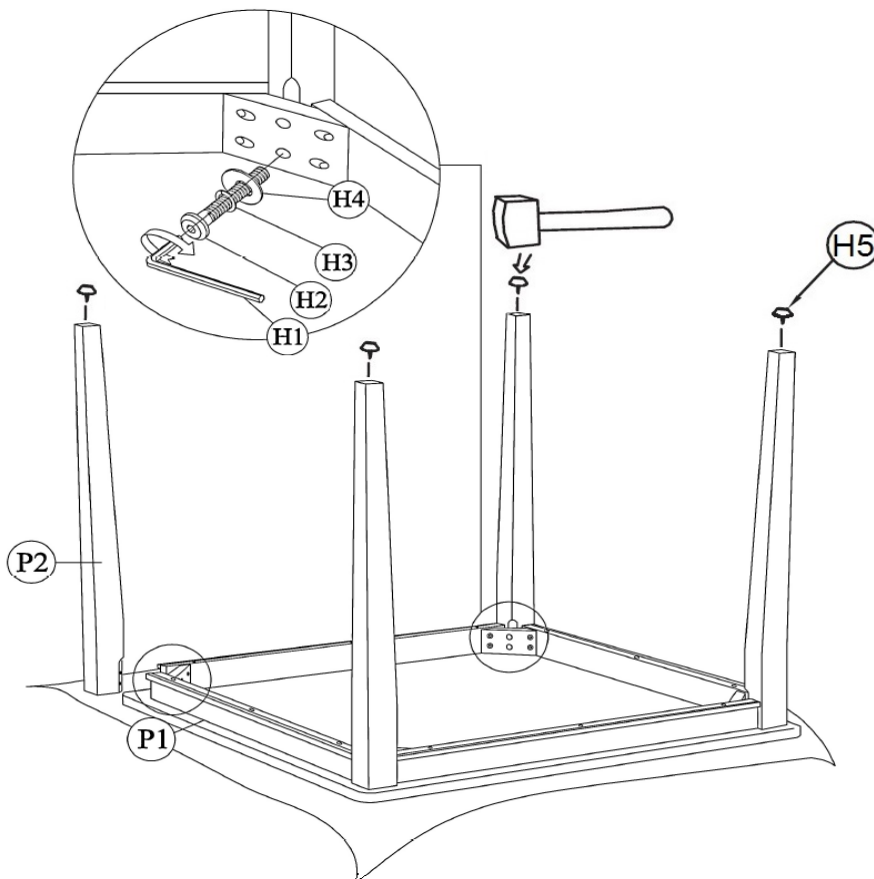

- a) With the assistance of another person, place Table Top (P1) bottom-side up on a flat & soft surface to prevent scratch and damage.
- b) Position Table Leg (P2) against the corners of the table aprons and align the screw holes on (P2) to the screw holes on the corner block.
- c) Insert Screw (H2) fitted with Spring Washer (H3) and Flat Washer (H4) through each hole on the corner block into screw hole on (P2). Use Allen Key (H1) to drive (H2) to fasten (P2) to corner block. Do not tighten (H2) completely until both screws are in place on each leg. Do not over-tighten.
- d) Repeat the above assembly procedure for the other three legs.
- e) Use a mallet or hammer to gently nail Leg Stud (H5) into each end of the Leg.
- f) Set the table right-side up when all 4 legs are installed.  
The assembly of the table is complete.