

QUEEN HEADBOARD
 QUEEN FOOTBOARD
 QUEEN RAILS

Assembly Instruction

A. Components :

- | | |
|--------------------|-----|
| 1. Headboard Panel | 1 x |
| 2. Footboard Panel | 1 x |
| 3. HB Right Leg | 1 x |
| 4. HB Left Leg | 1 x |
| 5. Stretcher | 1 x |
| 6. Bed Rail | 2 x |
| 7. Slat | 4 x |
| 8. Slat Support | 4 x |

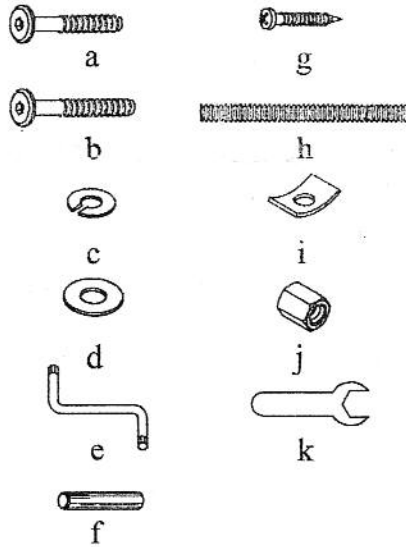

B. Hardware :

- | | |
|---------------------|-----|
| a. Allen Bolt Short | 2 x |
| b. Allen Bolt Long | 8 x |
| c. Lock Washer | 8 x |
| d. Flat Washer | 8 x |
| e. Allen Key | 1 x |
| f. Dowel | 4 x |
| g. Screw | 8 x |
| h. Stud Bolt | 8 x |
| i. Square Washer | 8 x |
| j. Hex Nut | 8 x |
| k. Wrench | 1 x |

B. Tool Required :

1. Screw Driver = (not included)



STEP 1

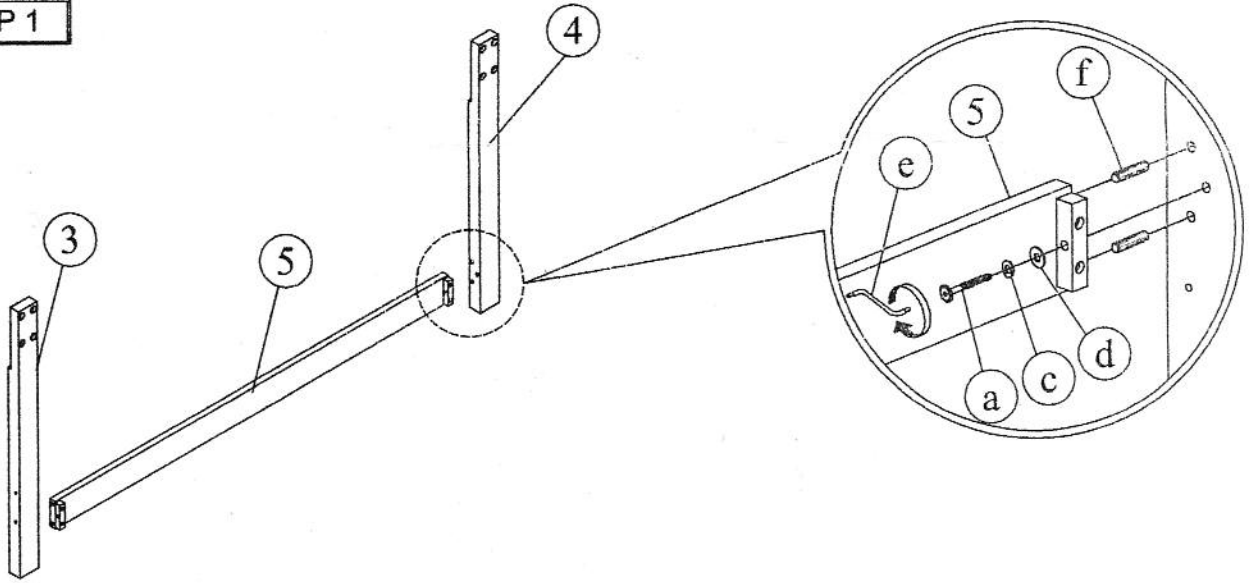

STEP 2

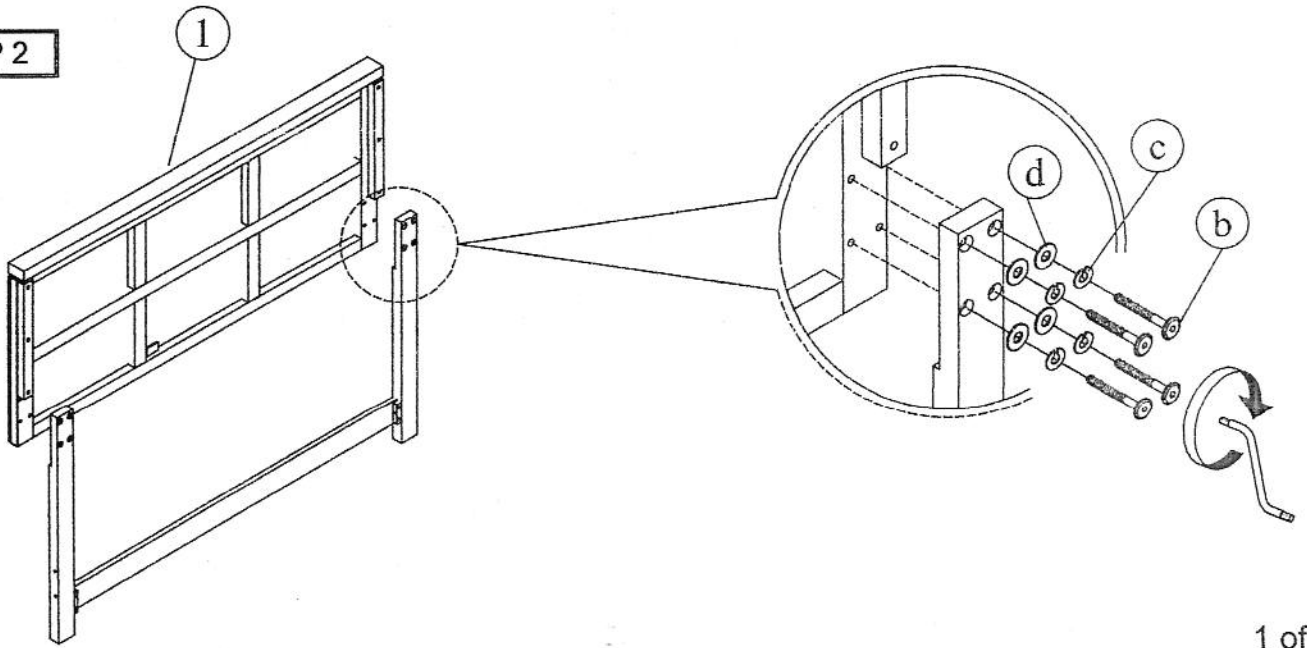

QUEEN HEADBOARD
QUEEN FOOTBOARD
QUEEN RAILS

STEP 3

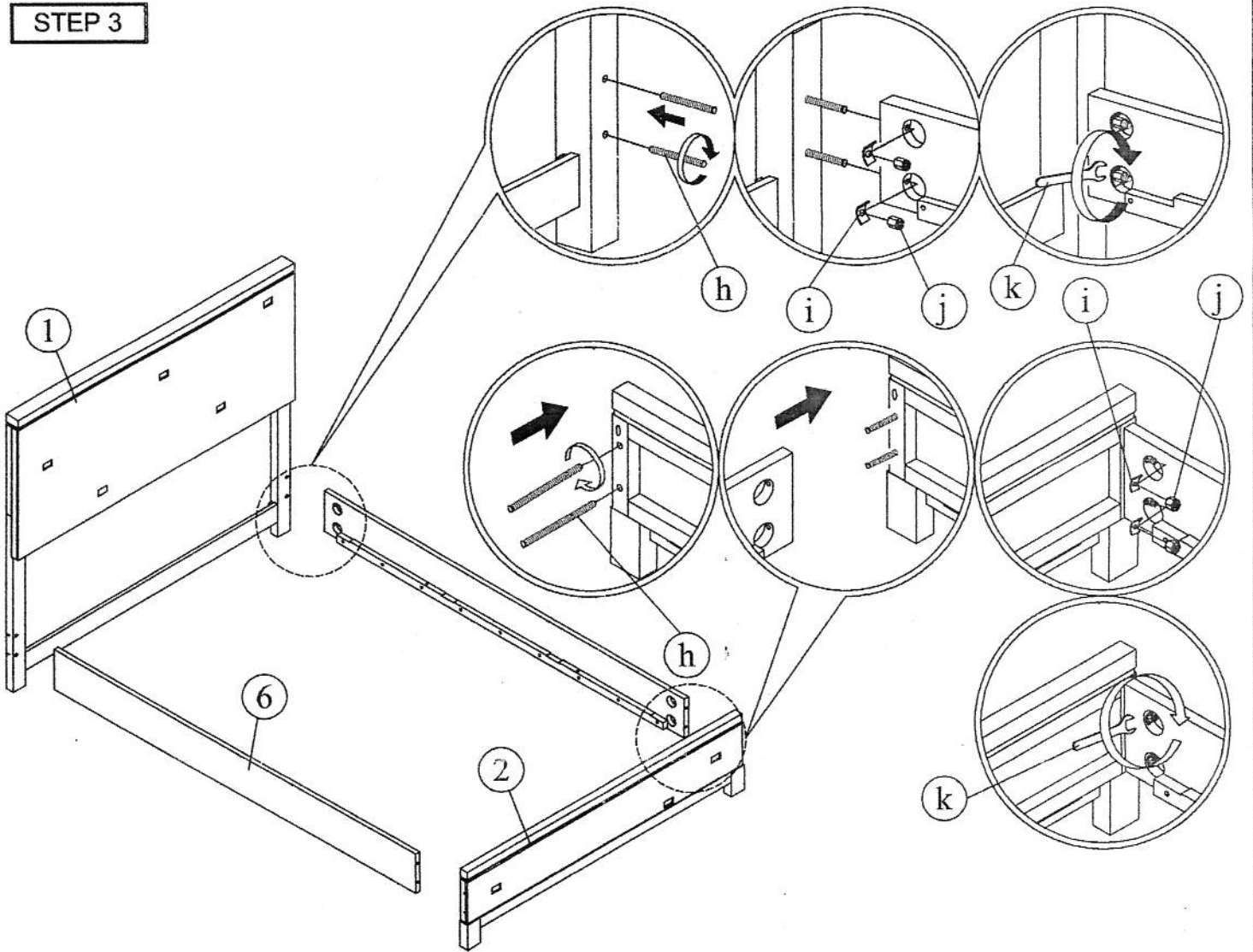

STEP 4

