













CARE AND MAINTENANCE

Wipe clean with a soft, dry cloth. The seat board can be cleaned with a mild cleaner. Test the cleaning method on a hidden area before using them over the entire area.

NOTICE

- * Please make sure that you have all parts indicated before you begin assembly of this item.
- * This item should be assembled on a soft surface to prevent scratching the finished product during assembly.
- * This item may require periodic tightening.
- * Do not tighten bolts until completely assembled.

Part List and Hardware List

Piece	Description	Picture	Quantity
A	L/FRONT LEG		1 X
B	R/FRONT LEG		1 X
C	CHAIR BACK		1 X
D	SEAT FRAME		1 X
E	SEAT CUSHION		1 X
F	L/STRETCHER		1 X
G	R/STRETCHER		1 X
H	FRONT STRETCHER		1 X
H1	BOLT $\phi 5/16$ "*3-1/4"		4 X
H2	BOLT $\phi 5/16$ "*2"		6 X
H3	L WRENCH		1 X
H4	SCREW $\phi 8$ *15MM		4 X
H5	SCREW $\phi 8$ *40MM		6 X

Product Dimensions:19-1/4"W*23-1/2"D*43-1/4"H

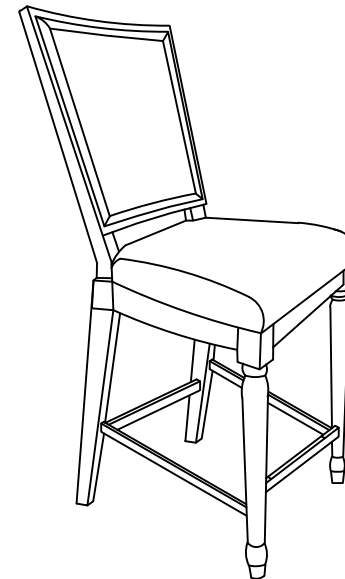

Weight Capacity: 275 lbs
WARNING:DO NOT STAND ON THE CHAIR

PREPARATION

Before beginning assembly of product, make sure all parts are present. Compare parts with package contents list and hardware contents list. If any part is missing or damaged, do not attempt to assemble the product.

Estimated Assembly Time:17 minutes.

Tools Required for Assembly (included):Wrench.

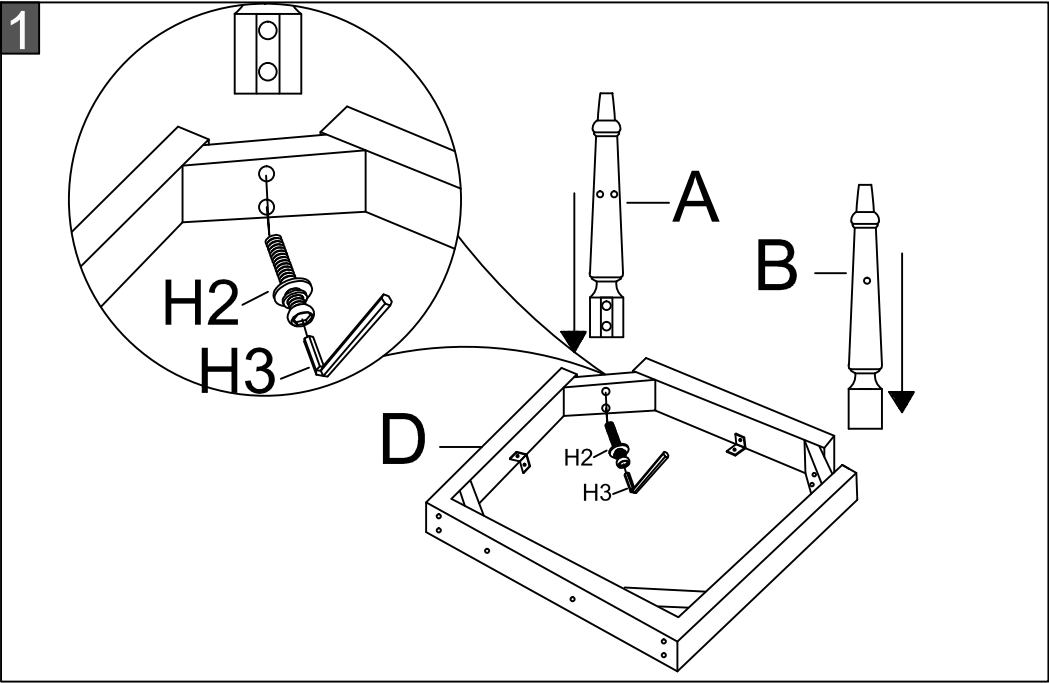

Step 1
Assemble legs (A) and (B) with seat frame (D). Use L-wrench (H3) to lock with 4*bolts (H2).

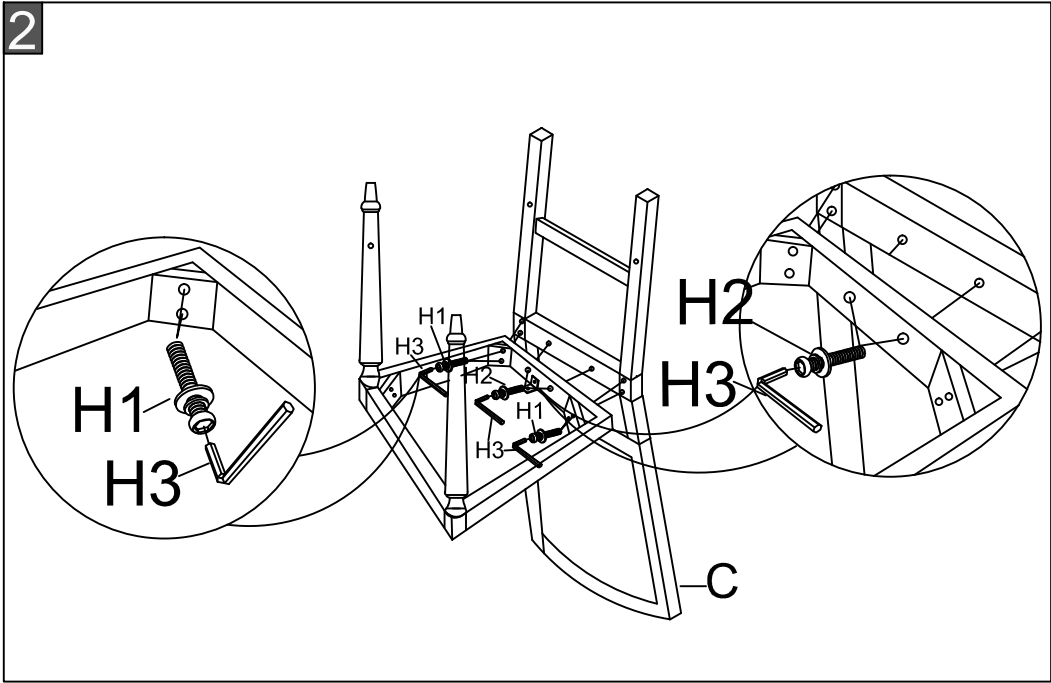

Step 2
Attach chair back (C) with the assembled seat frame/legs. Lock with 6 bolts (2*H2 &, 4* H1) by using L-wrench(H3).

PREPARATION

Before beginning assembly of product, make sure all parts are present. Compare parts with package contents list and hardware contents list. If any part is missing or damaged, do not attempt to assemble the product.

Estimated Assembly Time:17 minutes.

Tools Required for Assembly (included):Wrench.

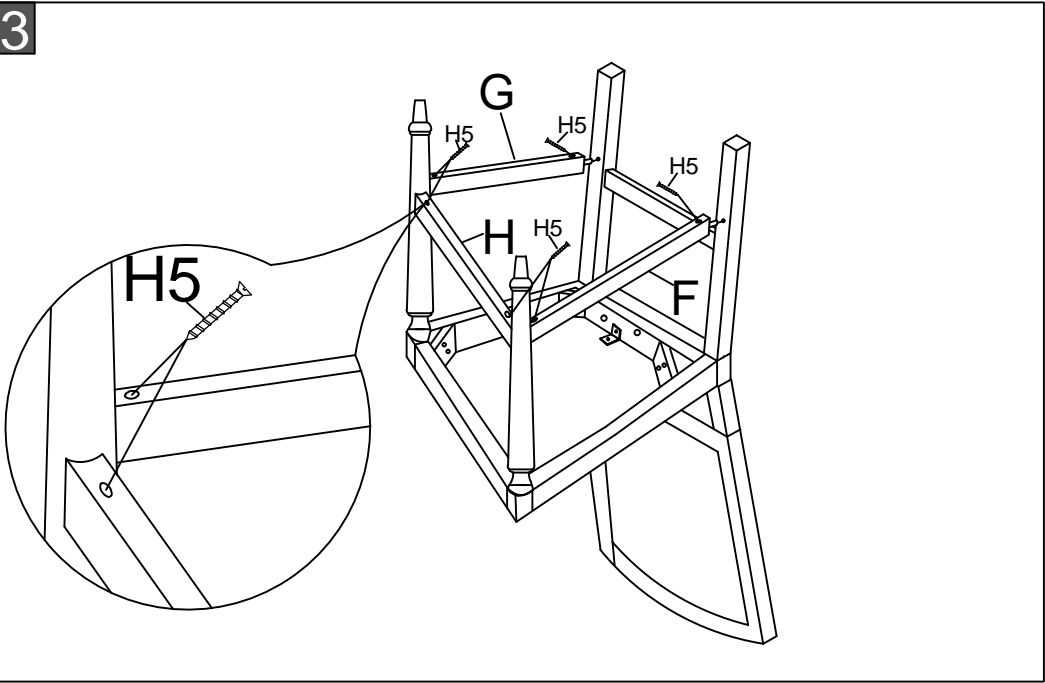

Step 3
Assemble stretchers (F), (G) and (H) with legs. Use 8*screws (H5) to lock.

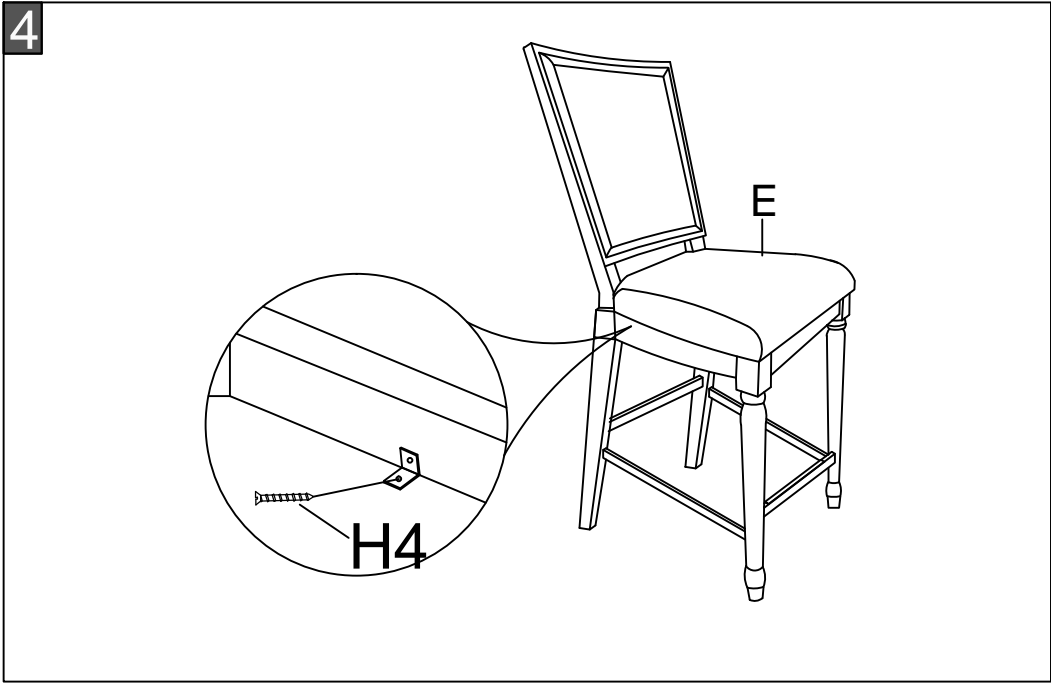

Step 4
Place seat cushion (E) on top of seat frame. Lock with angle irons & screws (H4).Assembly is completed.