

ASSEMBLY INSTRUCTION

NOTES:

- Do not skip any step.
- Do not fully tight screws until all the bed parts are assembled.









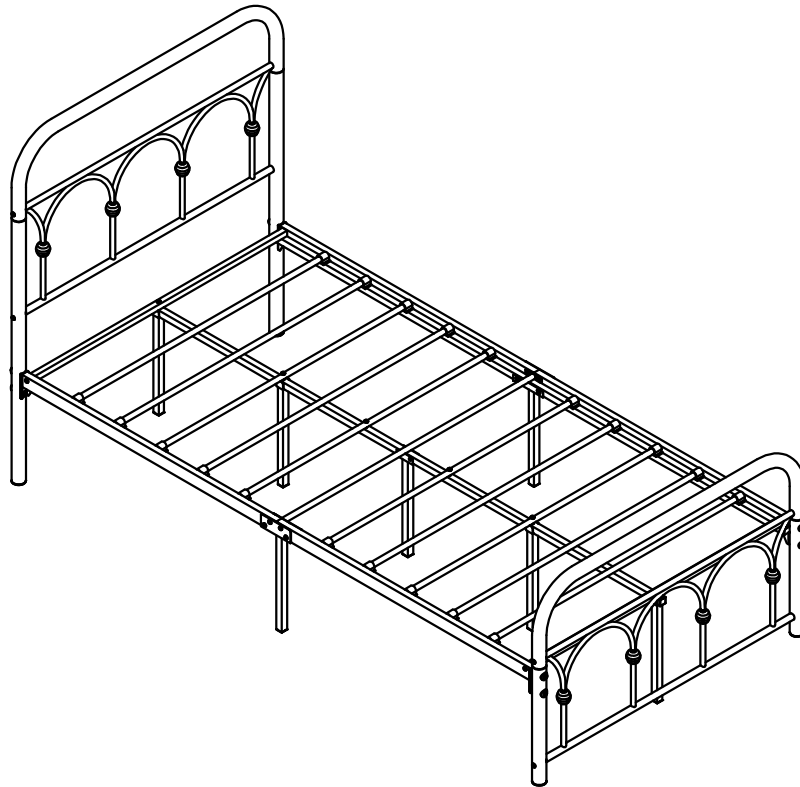

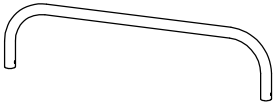

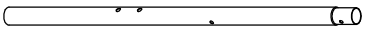

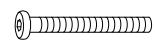
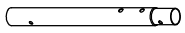
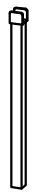
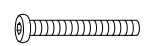

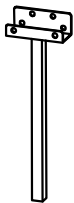

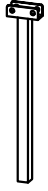



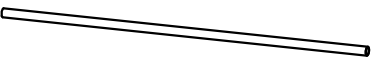
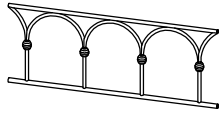









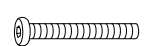

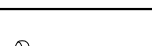
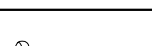
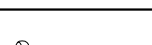





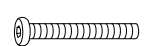

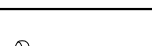
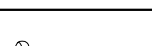
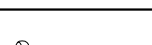

WARNING:

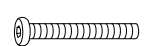

- WARNIND FOR YOUNG CHILDREN-This product contains small components,please ensure that they are kept away from small children while assembling.

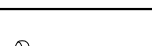
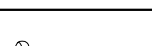
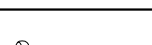
Warranty Information:

- We warranty this product to be free from defects in materials.
This warranty covers one year from the date of original purchase.
If you have any query about bed, please contact us.



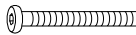



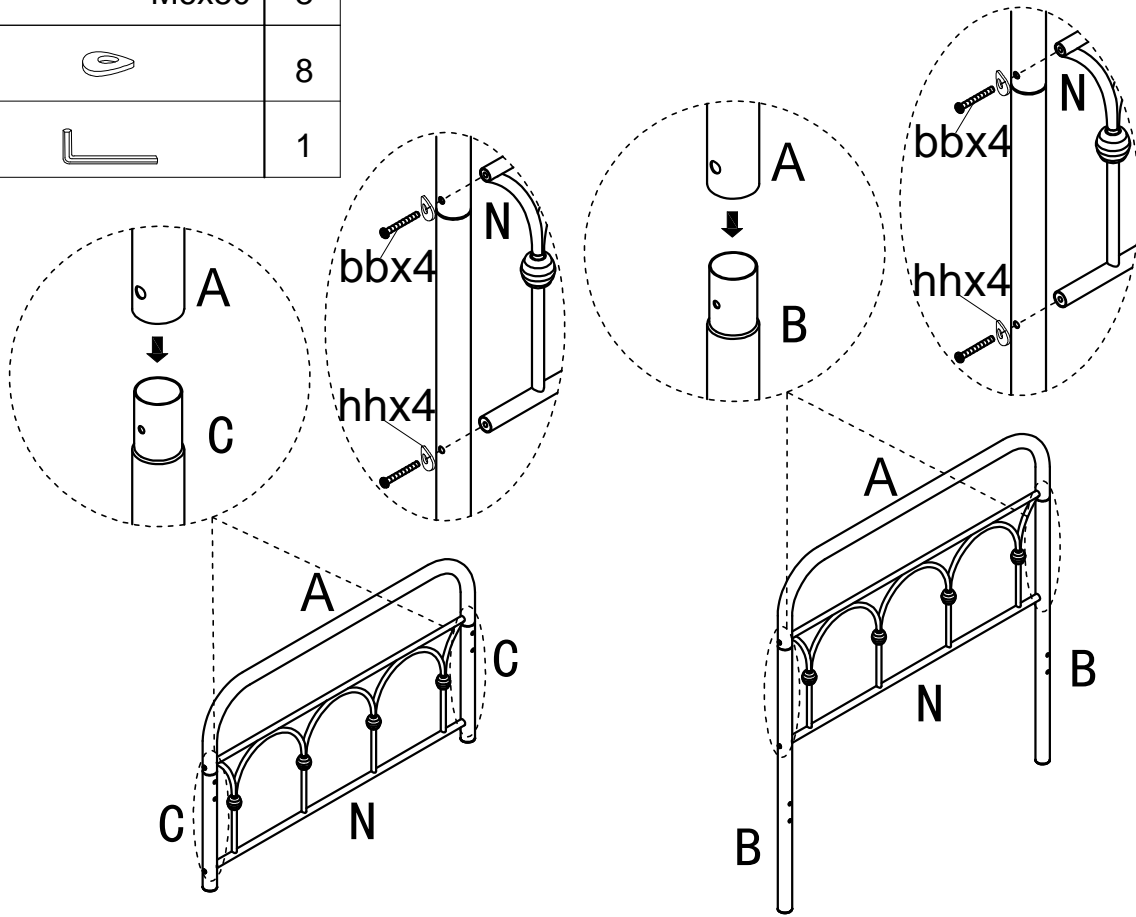

<p style="text-align: center;">A</p>  <p style="text-align: center;">2PCS</p>	<p style="text-align: center;">H</p>  <p style="text-align: center;">2PCS</p>	aa	 M8x55	4																														
<p style="text-align: center;">B</p>  <p style="text-align: center;">2PCS</p>	<p style="text-align: center;">I</p>  <p style="text-align: center;">2PCS</p>	bb	 M6x50	12																														
<p style="text-align: center;">C</p>  <p style="text-align: center;">2PCS</p>	<p style="text-align: center;">J</p>  <p style="text-align: center;">4PCS</p>	cc	 M6x40	4																														
<p style="text-align: center;">D</p>  <p style="text-align: center;">2PCS</p>	<p style="text-align: center;">K</p>  <p style="text-align: center;">2PCS</p>	dd	 M6x35	8																														
<p style="text-align: center;">E</p>  <p style="text-align: center;">2PCS</p>	<p style="text-align: center;">L</p>  <p style="text-align: center;">1PC</p>	ee	 M6x30	2																														
<p style="text-align: center;">F</p>  <p style="text-align: center;">4PCS</p>	<p style="text-align: center;">M</p>  <p style="text-align: center;">1PC</p>	ff	 M6x25	2																														
<p style="text-align: center;">G</p>  <p style="text-align: center;">6PCS</p>	<p style="text-align: center;">N</p>  <p style="text-align: center;">2PCS</p>	gg	 M6x15	4																														
		hh		16																														
		ii		12																														
		jj		2																														
		kk		1																														
		ll		2																														
		mm		1																														
		nn		20																														
		SPARE <table border="1" style="margin-left: auto; margin-right: auto;"> <tr> <td data-bbox="1157 1245 1236 1317">bb</td> <td data-bbox="1236 1245 1455 1317">  </td> <td data-bbox="1455 1245 1535 1317">1</td> </tr> <tr> <td data-bbox="1157 1317 1236 1388">cc</td> <td data-bbox="1236 1317 1455 1388">  </td> <td data-bbox="1455 1317 1535 1388">1</td> </tr> <tr> <td data-bbox="1157 1388 1236 1460">dd</td> <td data-bbox="1236 1388 1455 1460">  </td> <td data-bbox="1455 1388 1535 1460">1</td> </tr> <tr> <td data-bbox="1157 1460 1236 1532">ee</td> <td data-bbox="1236 1460 1455 1532">  </td> <td data-bbox="1455 1460 1535 1532">1</td> </tr> <tr> <td data-bbox="1157 1532 1236 1603">ff</td> <td data-bbox="1236 1532 1455 1603">  </td> <td data-bbox="1455 1532 1535 1603">1</td> </tr> <tr> <td data-bbox="1157 1603 1236 1675">gg</td> <td data-bbox="1236 1603 1455 1675">  </td> <td data-bbox="1455 1603 1535 1675">1</td> </tr> <tr> <td data-bbox="1157 1675 1236 1747">hh</td> <td data-bbox="1236 1675 1455 1747">  </td> <td data-bbox="1455 1675 1535 1747">1</td> </tr> <tr> <td data-bbox="1157 1747 1236 1818">ii</td> <td data-bbox="1236 1747 1455 1818">  </td> <td data-bbox="1455 1747 1535 1818">1</td> </tr> <tr> <td data-bbox="1157 1818 1236 1890">jj</td> <td data-bbox="1236 1818 1455 1890">  </td> <td data-bbox="1455 1818 1535 1890">1</td> </tr> <tr> <td data-bbox="1157 1890 1236 1962">nn</td> <td data-bbox="1236 1890 1455 1962">  </td> <td data-bbox="1455 1890 1535 1962">1</td> </tr> </table>			bb		1	cc		1	dd		1	ee		1	ff		1	gg		1	hh		1	ii		1	jj		1	nn		1
bb		1																																
cc		1																																
dd		1																																
ee		1																																
ff		1																																
gg		1																																
hh		1																																
ii		1																																
jj		1																																
nn		1																																
		<div style="border: 1px solid black; padding: 5px; display: inline-block;">2/7</div>																																

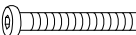
bb	 M6x50	8
hh		8
ll		1

Step 1







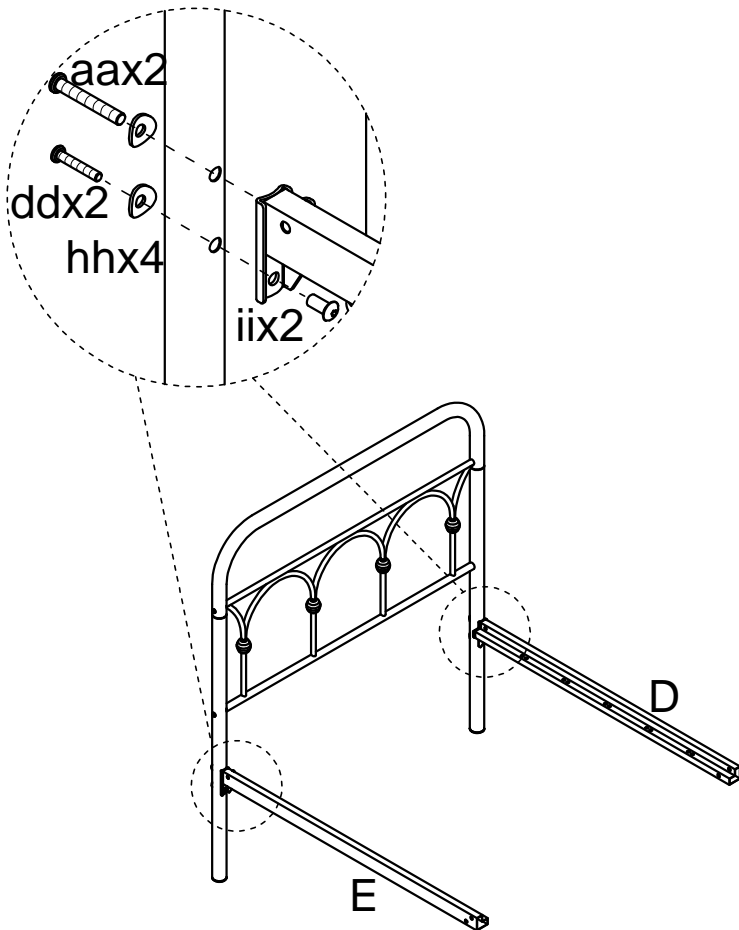

aa	 M8x55	2
dd	 M6x35	2
hh		4
ii		2
kk		1
ll		2

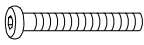
Step 2



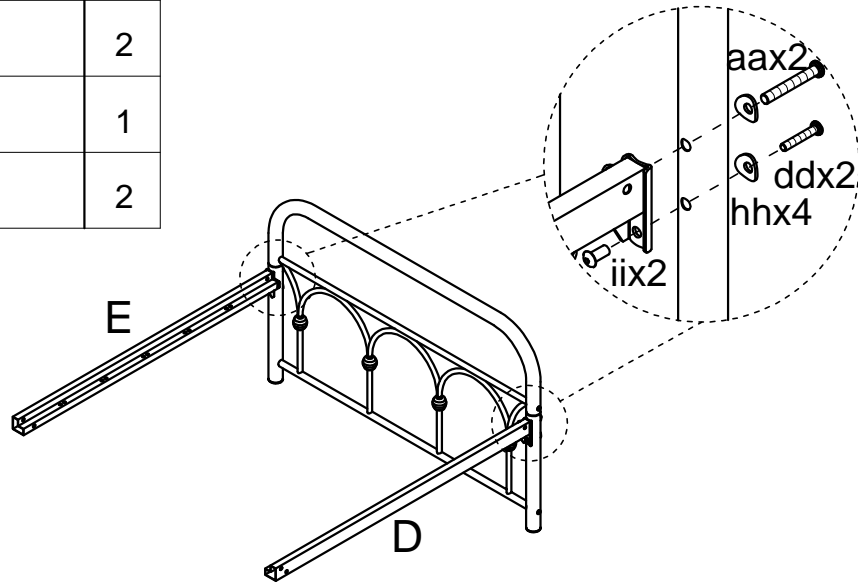

Step 3

aa		M8x55	2
dd		M6x35	2
hh			4
ii			2
kk			1
ll			2



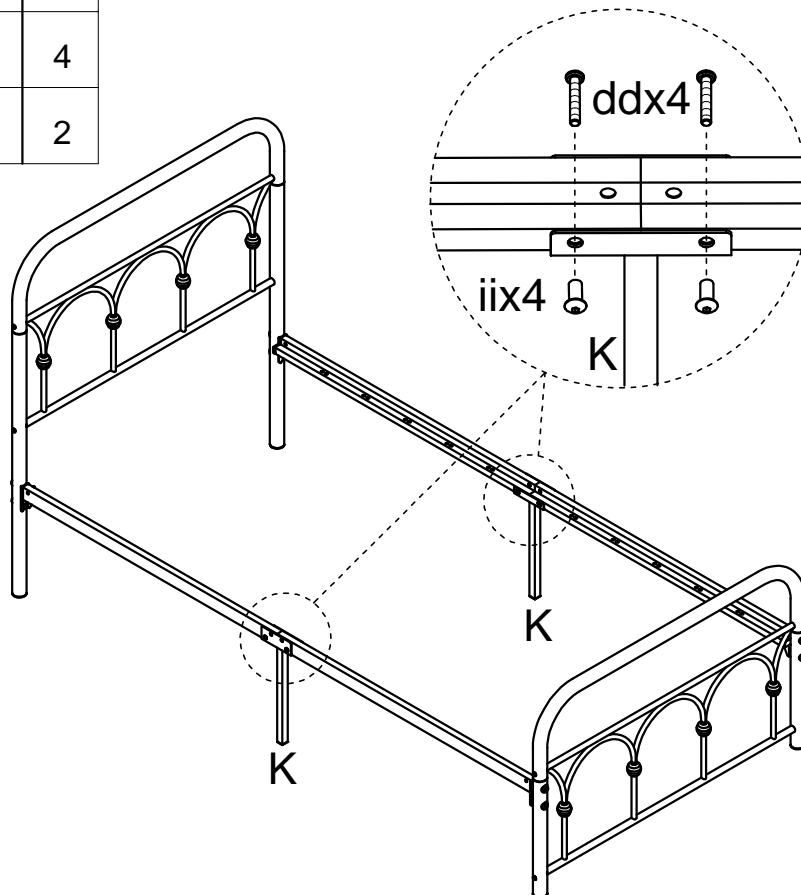

Step 4

dd		M6x35	4
ii			4
ll			2



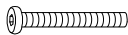

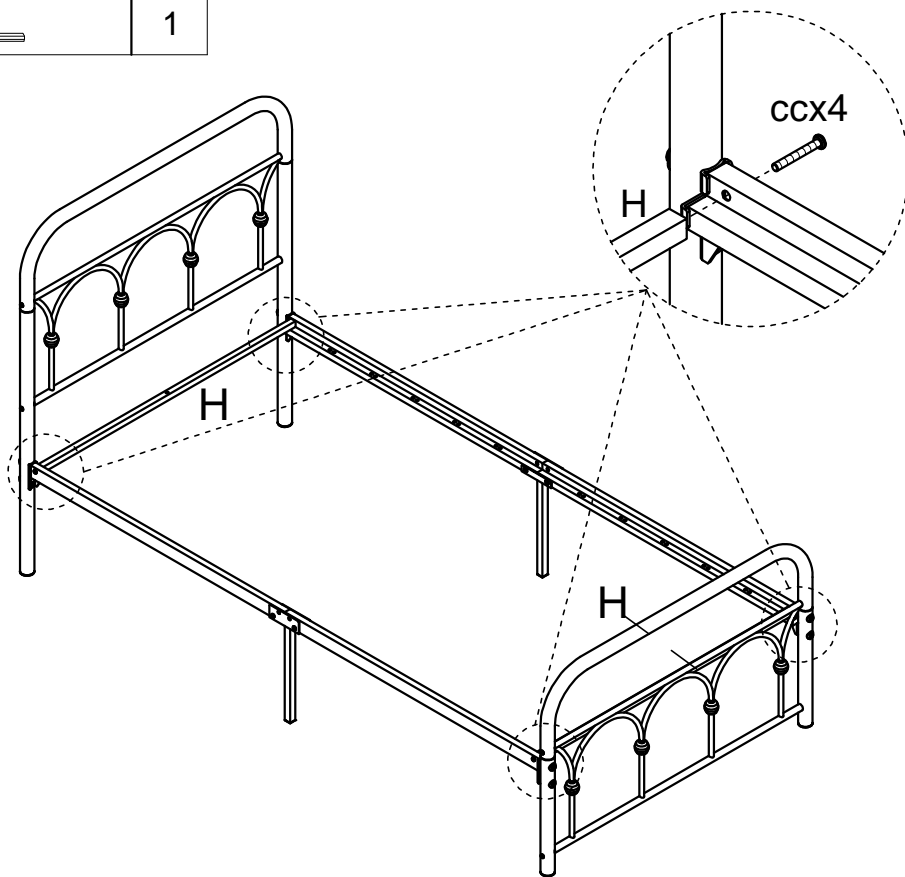

Step 5

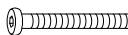
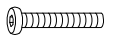

cc		M6x40	4
ll			1

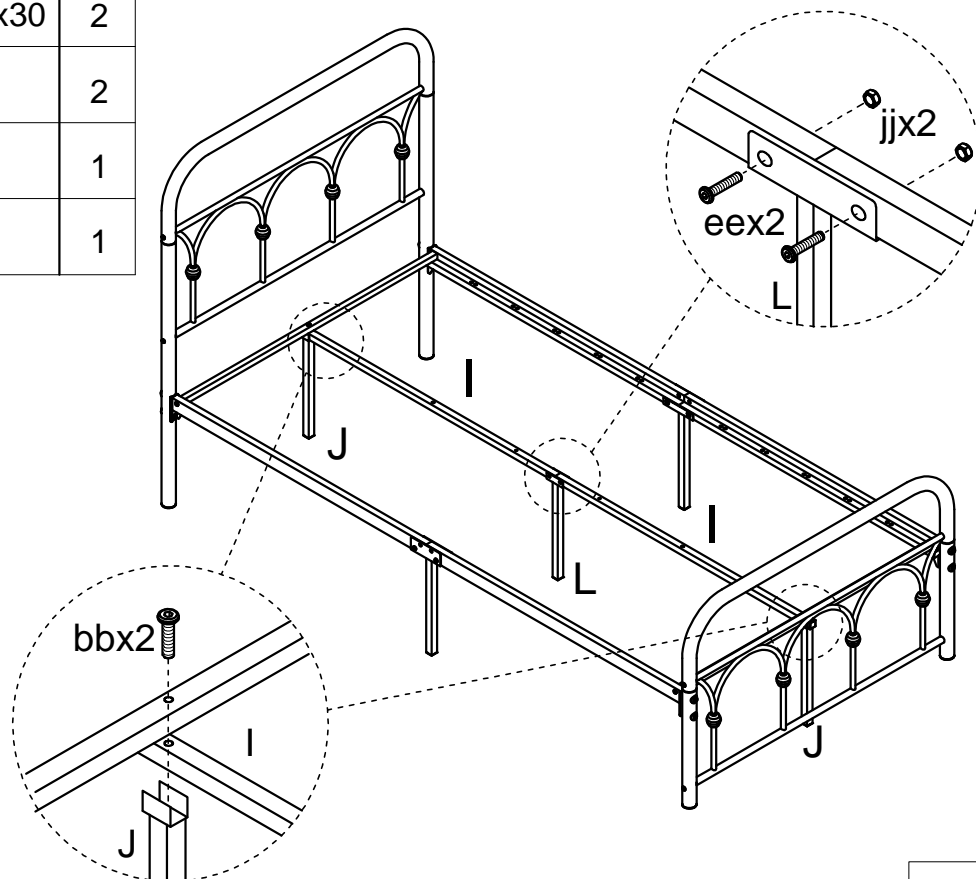

Step 6

bb		M6x50	2
ee		M6x30	2
jj			2
ll			1
mm			1



gg		M6x15	4
ii			4
ll			2

Step 7

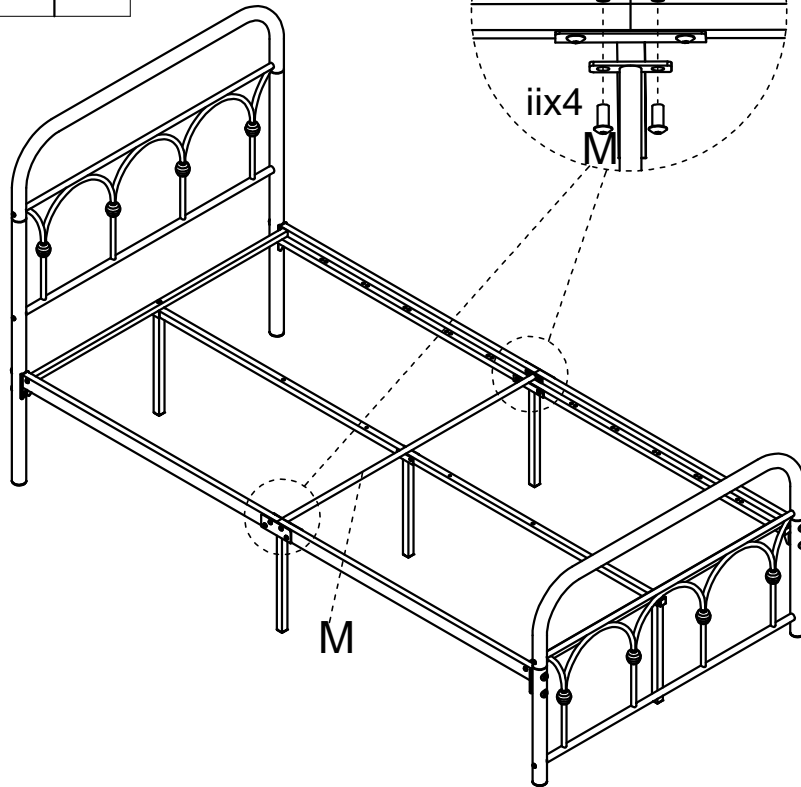

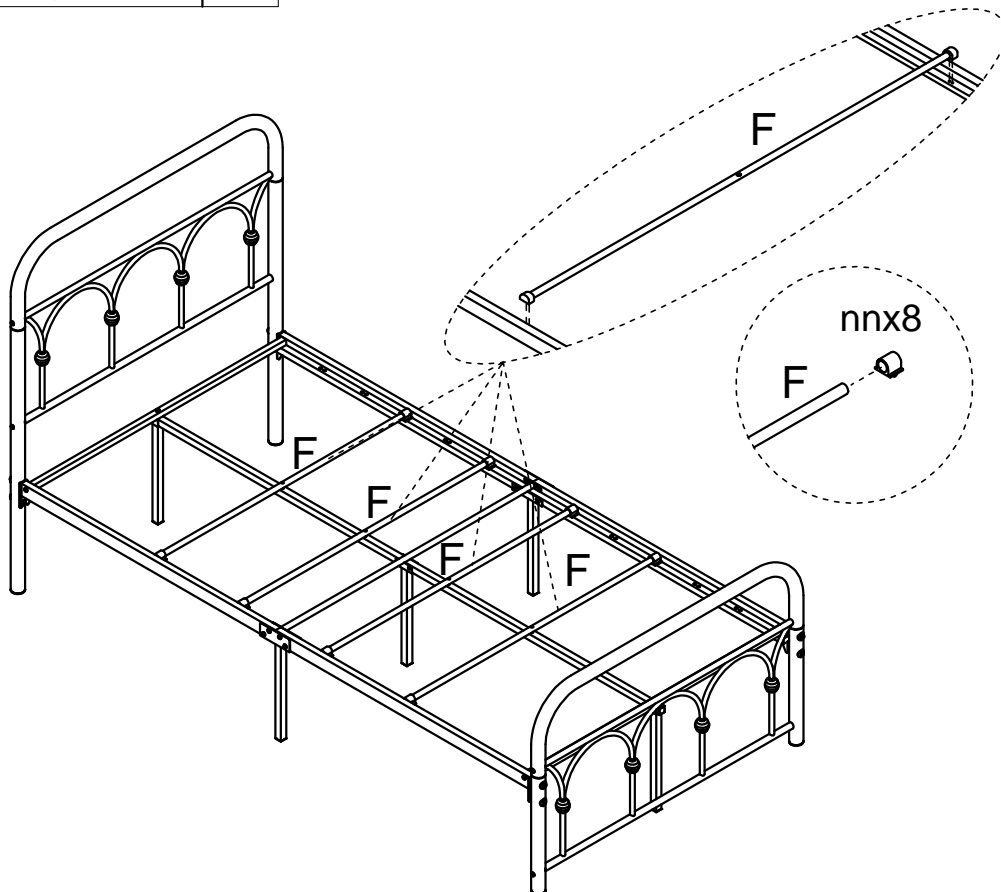

nn		8
----	---	---

Step 8

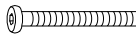

Step 9

bb		M6x50	2
ff		M6x25	2
ll			1

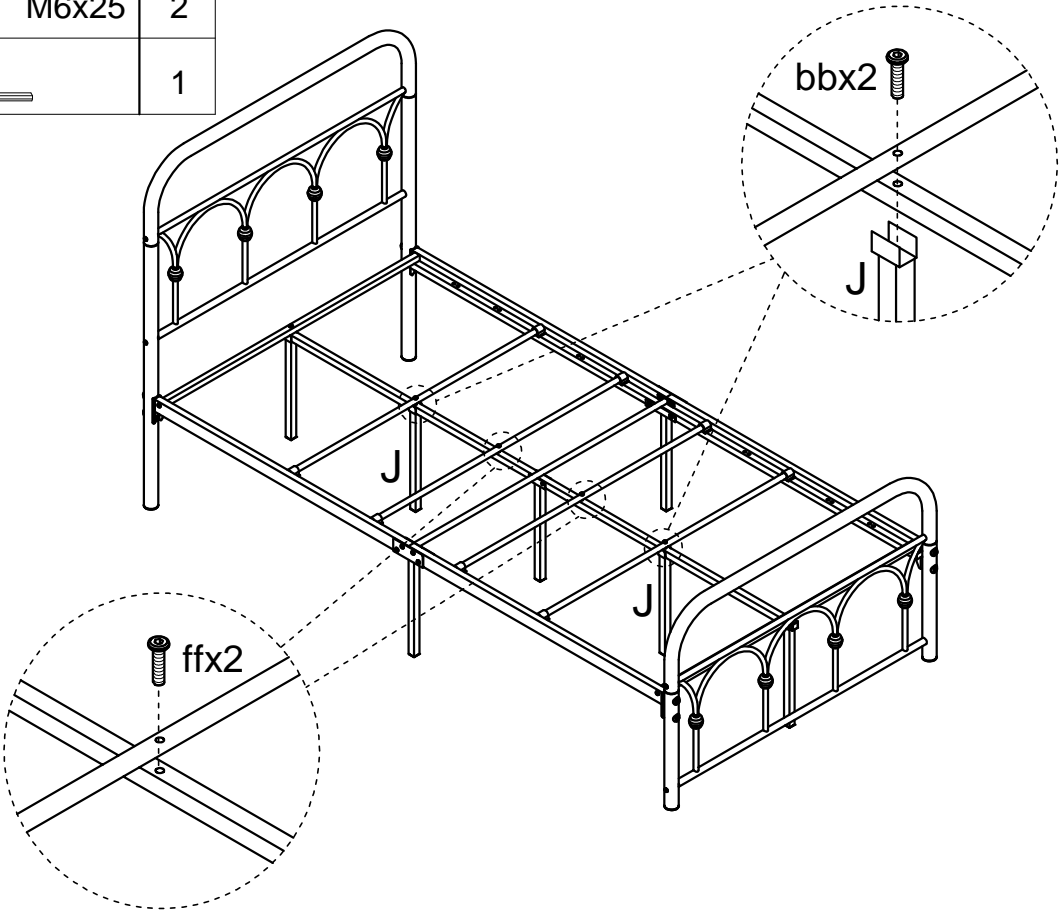

Step 10

nn			12
----	---	--	----

