

Puppy Buddy Series
4'x4'x4.8'

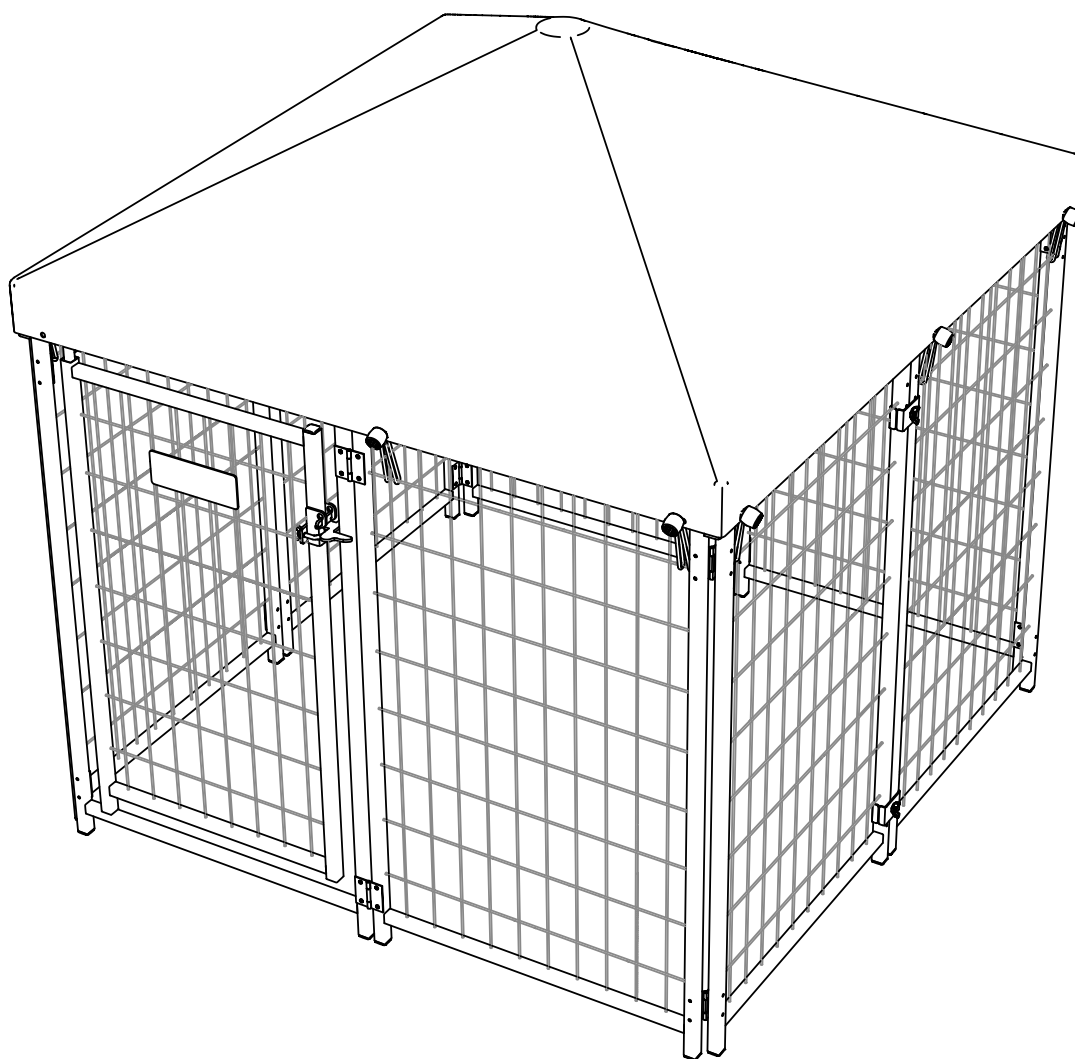

Folding Hinges Kennel

INSTRUCTION MANUAL



IMPORTANT: READ THIS INSTRUCTION CAREFULLY BEFORE PROCEEDING.

This manual will provide you with clear and detailed instructions on how to safely and correctly assemble and maintain your Pet Kennel, to ensure it brings you enjoyment.

FOLLOW US ON

 @abbapatio











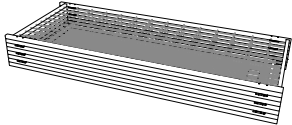

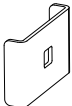

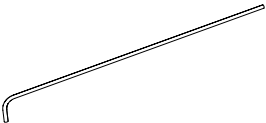

 @abbapatio

 @Abba_Patio

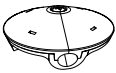
 @abbapatio_official

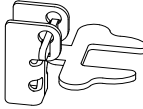

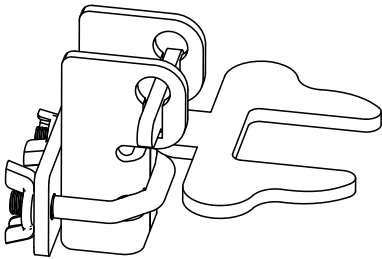
PARTS LIST

Make sure all parts listed below have been included in your package.

REF	PART NAME	QTY	REF	PART NAME	QTY
A	 Panel	1	J	 Canopy roof	1
B	 Panel clamp	4	K	 Elastic ball strap	11+3
C	 Coner plug	4+1	L	 Foot pad	16+1
D	 Plug	4+1	M	 Bolt	2
E	 Roof frame	4	N	 Wing nut	2
F	 Roof disc	1	O	 Ground stake	8+2
			G	 Lock	1
			H	 Lock plate	1
	Gate latch (pre-assembled)	1	I	 C-ring	1
			N	 Wing nut	2

ASSEMBLY

1. Foot pad assembly

- A** x 1 
- L** x 16 

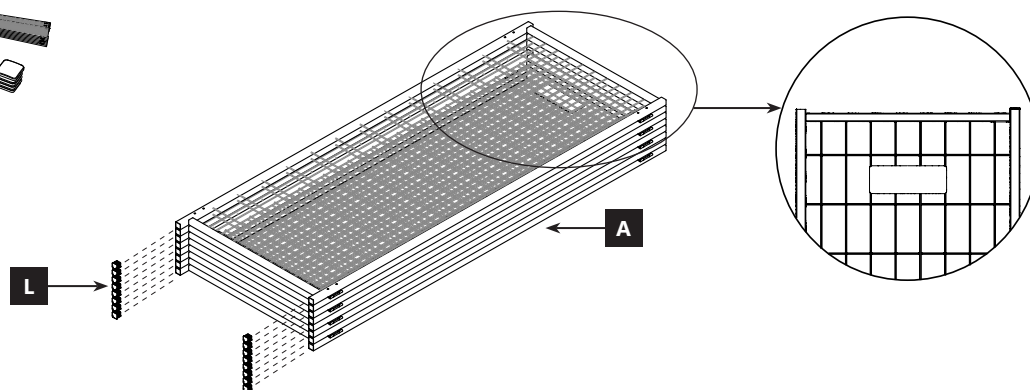

1A) Insert the foot pad **L** into the bottom of the panel **A**.

2. Plug assembly

- C** x 4 
- D** x 4 

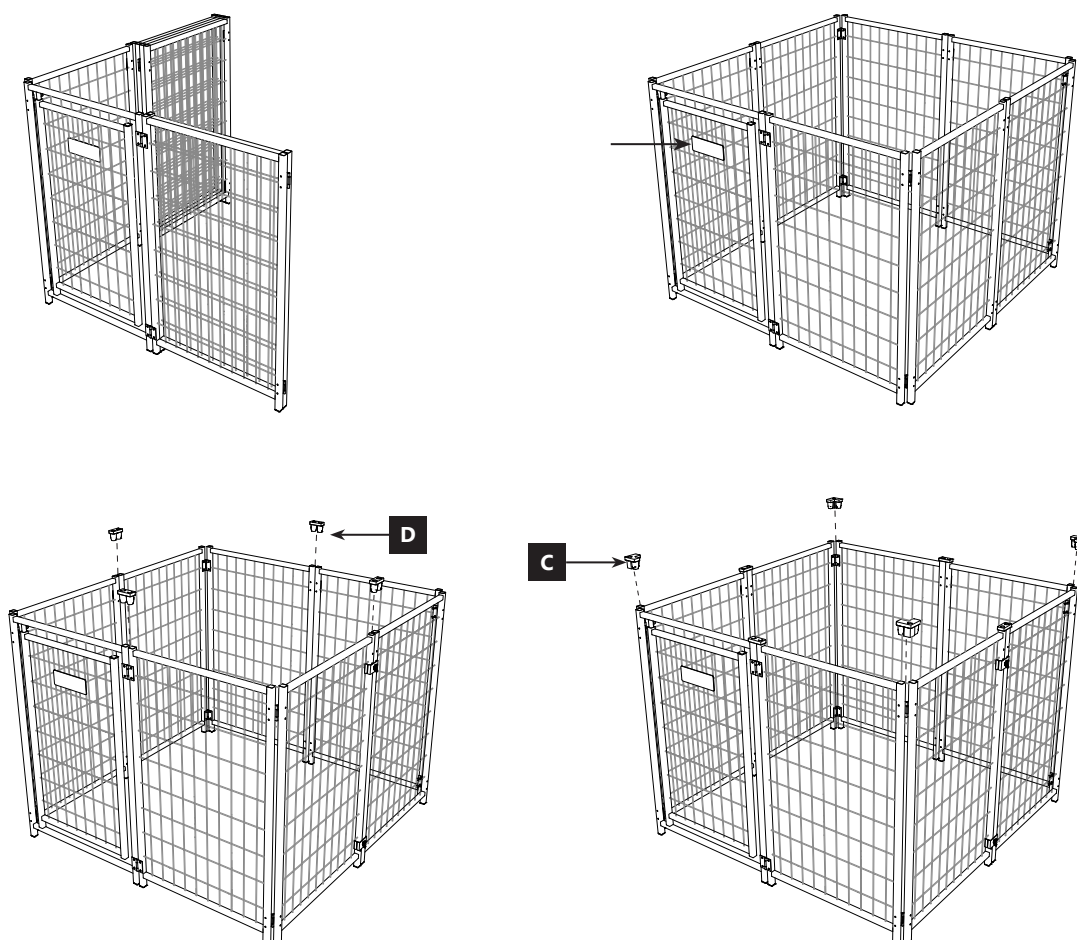

2A) Unfold the panel **A** and insert the coner plug **C** and plug **D** to shape the product into a square.
Note: Ensure that the nameplate is positioned on the exterior of the kennel.



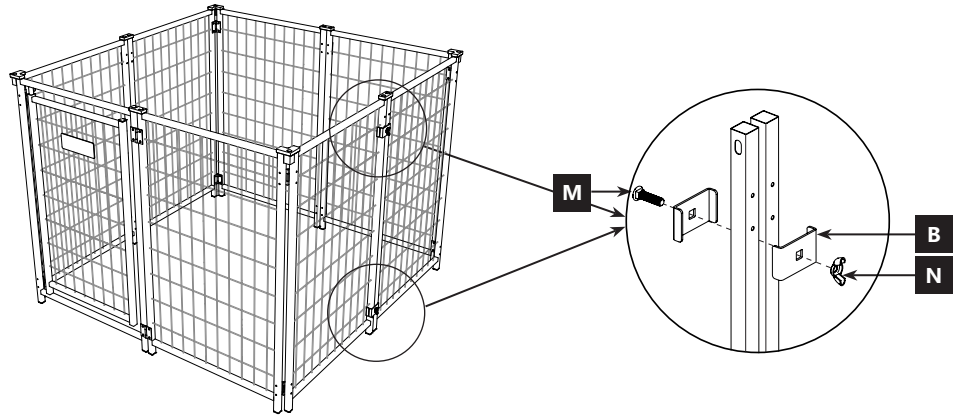

3. Connect the panel

- B** x4 
- M** x2 
- N** x2 



3A) Connect the panel with the panel clamp **B** by securing the clamp with bolt **M** and wing nut **N**.

4. Gate latch assembly

- G** x1 
- H** x1 
- I** x1 
- N** x2 

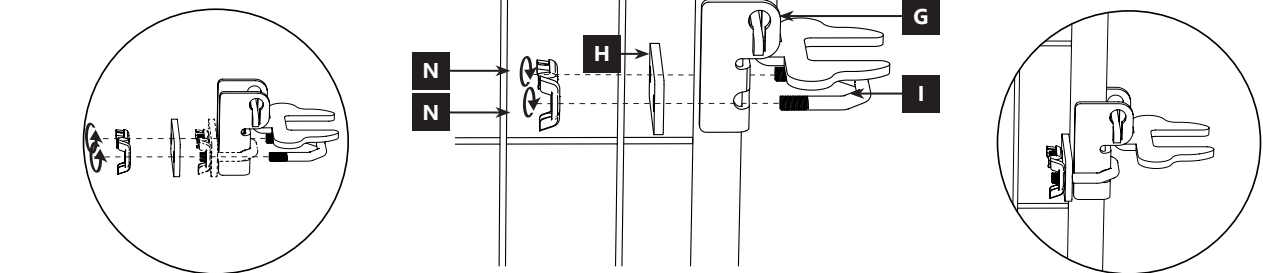

4A) Disassemble the gate latch by rotating wing nut **N** counterclockwise to remove lock plate **H**, then align the C-ring **I** with holes in lock plate **H** and secure it with wing nut **N** to secure the lock **G**.

5. Roof frame assembly

- E** x4 
- F** x1 

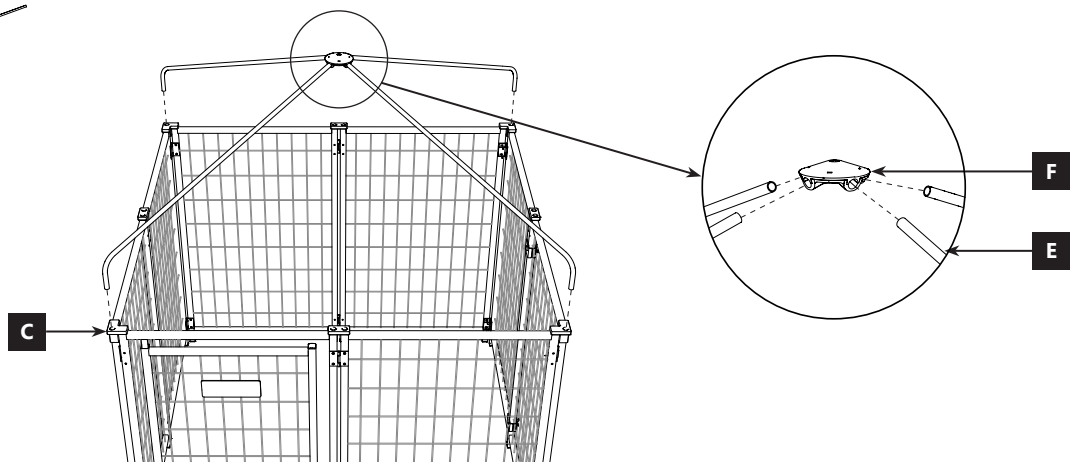

5A) Insert the roof frame **E** into the roof disc **F**, and assemble the roof frame assembly into corner plug **C**.

6. Canopy roof assembly

J x1 

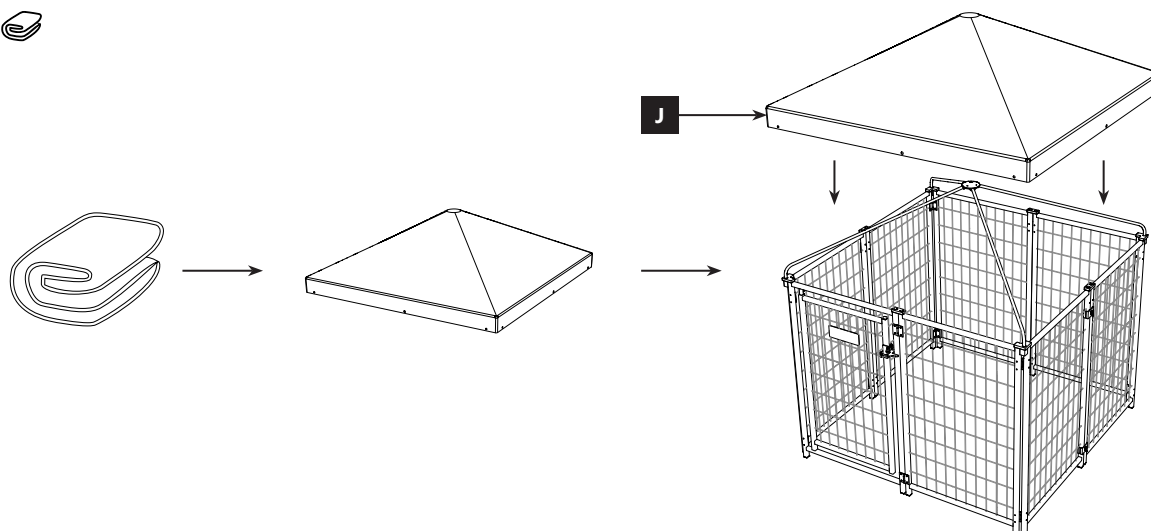

6A) Unfold the canopy roof **J** and place it over the roof frame **E**.

K x 11 

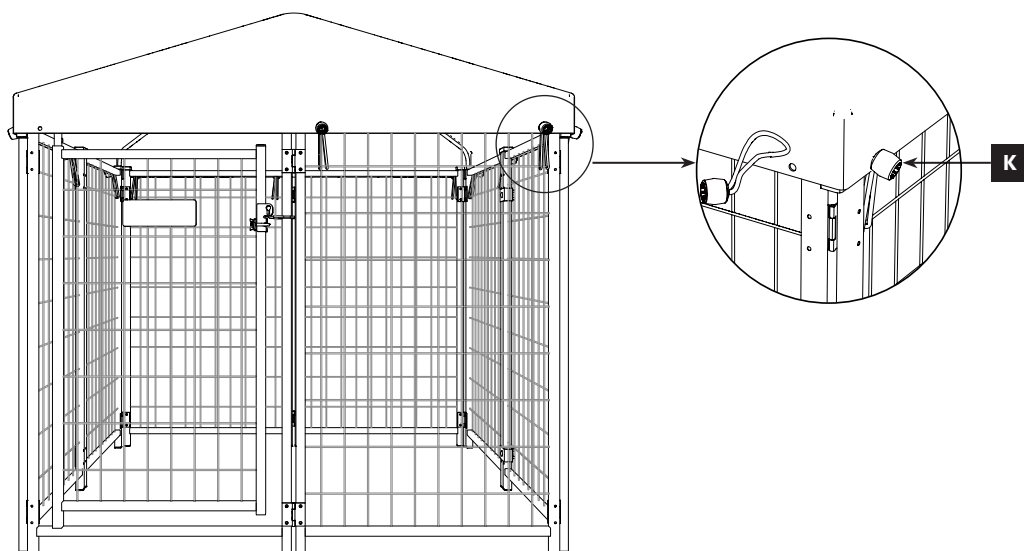

6B) Secure the canopy roof **J** with elastic ball strap **K**.

OPERATING

1. Stake down the kennel

o x 8 

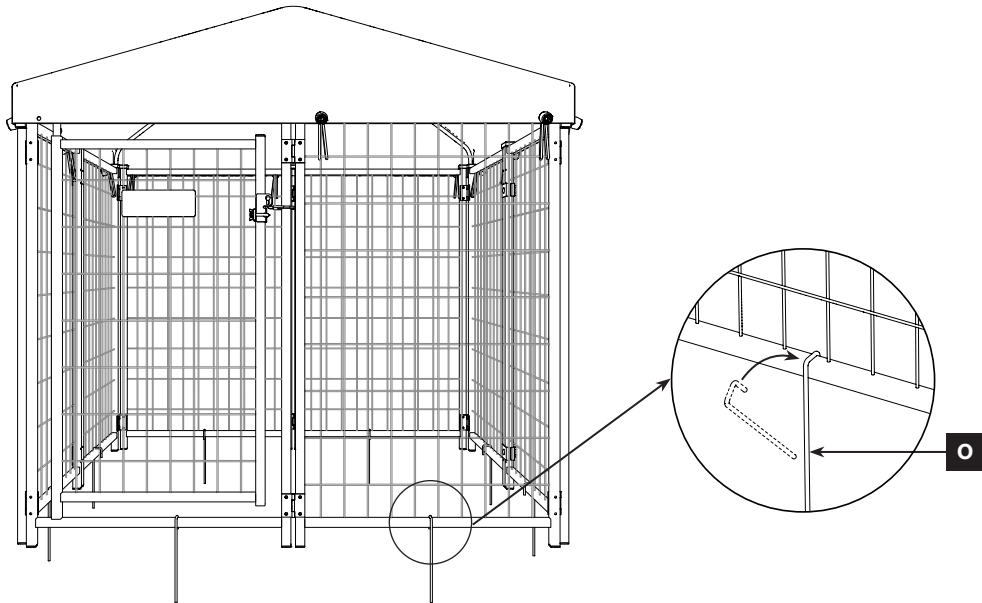

1A) Anchor the kennel to the soft ground with ground stake **o** provided.

2. Lock guide

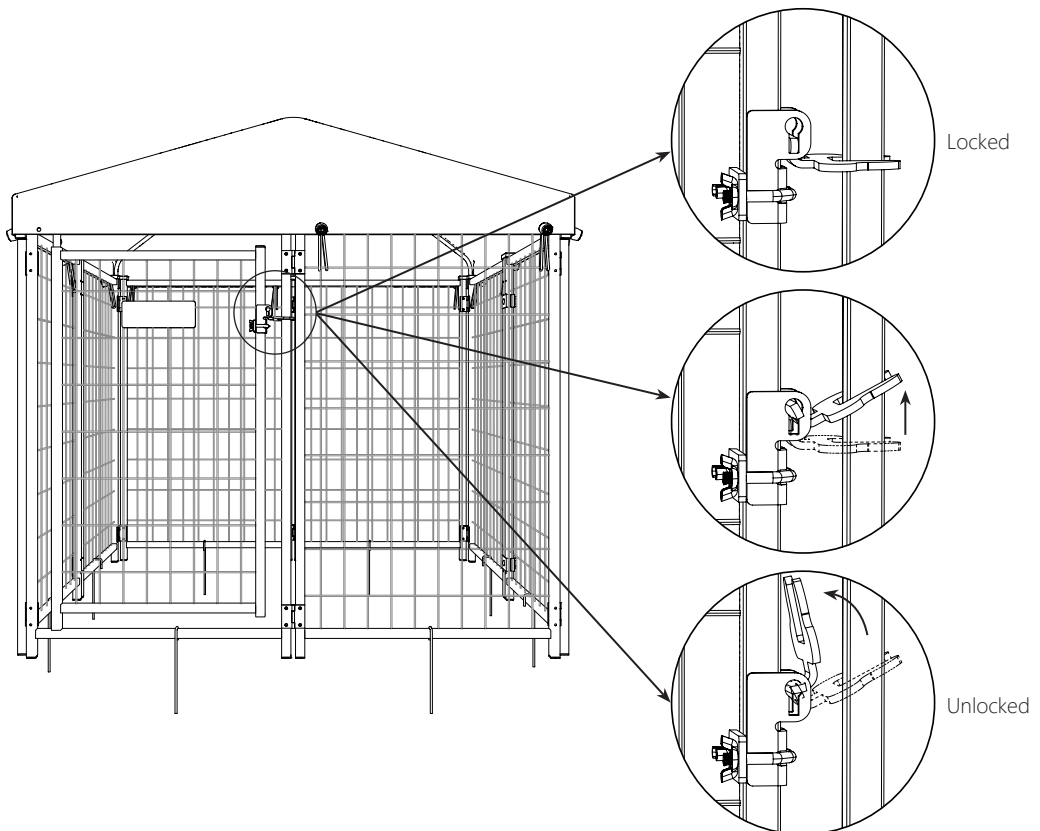

2A) Lift the lock upwards and rotate counterclockwise to unlock.

IMPORTANT INFORMATION

IMPORTANT! Read this information before proceeding.

WARNING:

When using dog kennel products outdoors, basic safety precautions should be followed to reduce unnecessary hazards, including the following:

- Adult assembly required. We recommend 1 or more people to install.
- Do not assemble the kennel on a stormy day. It will be damaged.
- Keep children and pets away from the assembly area until the work is completed.
- Choking hazard to children under the age of 3 years-contains small parts prior to assembly.
- When using outdoors, please check to make sure the ground stakes are assembled securely.
- Never continue to use a product that is structurally unsound.
- Do not touch moving parts during operation.
- Remove collars, tags, and leads from pet before placing it in the kennel to prevent possible entanglement.
- Please do not climb or lean on dog kennel.
- Please keep this item away from fire, gas, electricity, chemicals or sharp objects. Failure to follow these warnings or the instructions could result in serious injury or death.
- For pets only. This item is not a toy or intended for the use of children. Children are not allowed to use or play with the product.
- Do not leave pets in product for prolonged periods of time.
- Do not stand or put weight on the product, this could cause damage.
- In case of rainy and snowy weather, please clean up the accumulated snow and water regularly to avoid excessive accumulation of rain and snow that will affect the stability of the structure.

SAFTY ADVICE:

- Periodically inspect this product for damaged hardware, loose joints, missing parts, or sharp edges. Do not use the product if any parts are missing or broken.
- Keep clothing and body parts away from the dog kennel to prevent them from getting caught in the moving parts.
- In order to ensure the door can be opened quickly in an emergency, please keep clutter clear in front of the door when your pet is inside the kennel.
- Please wear work gloves, long sleeves, and safety goggles during assembly and disassembly to avoid pinching your fingers caused by improper operations.
- It is suggested to train and habituate your pet when beginning to use the product. Please consult a veterinarian before use to ensure the physical and mental health of your pet if needed.
- Please recycle packaging where possible.

CARE & MAINTENANCE

FRAME:

- Dust and dirt will collect on the dog kennel and will require periodic cleaning.
- Regularly lubricate the dog kennel to ensure smooth operation and prevent rusting and wear.
- When not in use, please store the dog kennel in a dry place and avoid direct sunlight to prevent material aging and deformation.
- Only Abba Patio® replacement parts should be used. It may be unsafe to use parts supplied by another manufacturer.

FABRIC:

1. Brush off loose dirt with a soft bristle brush.
2. Hose down.
3. Prepare a cleaning solution of water and mild.
4. Use a soft bristle brush to clean.
5. Allow cleaning solution to soak into the fabric.
6. A thorough rinse until all soap residue is removed.
7. Air dry.

WARRANTY TERMS

LIMITED WARRANTY:

- The dog kennel guaranteed to be free from any manufacturing defects for a period of 1 year from the date of purchase under normal use and in compliance with the operating instructions.
- The warranty is valid only in the original country of purchase. Abba Patio® reserves the right to exchange an item for a replacement part. Some parts may be replaced with newer model parts as the Puppy Buddy Series is improved over time.

COMPLAINTS PROCEDURE:

- The complaint must include an order number or transaction number. Goods without an order number or transaction number are not covered under the warranty.
- The complaint must include a detailed description of the defect, the name of the company which installed the product and the date when the defect was discovered.
- At Sorara Outdoor Living USA's discretion, customer must offer supplier the photos/videos of the issue/damaged parts. Otherwise, supplier reserves the right to refuse replacement parts or credit.
- Please save a copy of your purchase receipt.

CONTACT US FOR HELP

Customer Service: customer@abbapatio.com

Need Assistance? Call +1 (888) 899-5617

Hours of Operation:

Phone Support: Monday - Friday: 6:30 am - 4:30 pm, Saturday – Sunday: 8:30 am – 4:30 pm, PST.

Email Support: We are available 24 hours a day. Please allow up to 24 hours for a response.

Note: Our team is available to assist you during these hours. If you have any inquiries or require support outside of these hours, please leave a voicemail, send an email. We will get back to you promptly during the next available support hours. We thank you for your purchase!