

NOTICE

- * Please make sure that you have all parts indicated and they are in good condition before you begin assembly of this item. Refer to part list and hardware list below for guidance.
- * This item should be assembled on a soft surface to prevent scratching the finish during assembly.
- * This item may require periodic tightening.
- * If you are having difficulty, our friendly Customer Care team is always here to help. Please email customersupport@safavieh.com

PREPARATION

- * Before beginning assembly of product, make sure all parts are present. Compare parts with part contents list and hardware contents list.
- * If any part is missing or damaged, do not attempt to assemble the product.
- * Estimated Assembly Time: 10 minutes.
- * Tools Required for Assembly (included): Allen Key

CARE AND MAINTENANCE

WOOD CARE: Adhesive felt pads should always be applied to areas of furniture which make direct contact with flooring, said application will prevent damage to the furniture and or surfaces on which the furniture lies. Objects placed on articles of furniture should rest on non abrasive material as to prevent damage to the wood finish. Objects whose composition consists of plastic and rubber are known to discolor and damage the wood surfaces on which they rest. Wipe up spills immediately and avoid common hazards such as hot dishes, harsh solvents and abrasives. Cleaning should be done with soft lint free cotton cloth dampened with water or furniture polish. On highly used surfaces we recommend applying a quality paste wax which should be used on a regular basis to provide additional protection from scratches and spills. How often you apply the wax depends on how much wear the furniture receives.



ITEM ID: BST3300

ITEM DIMENSION: W19.3"x D19"x H42.7"x SH24"

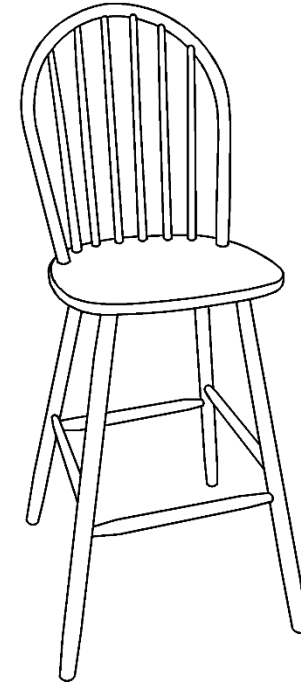









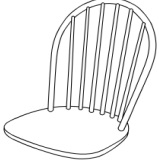

⚠ WARNING ⚠

Weight Capacity : 225lbs

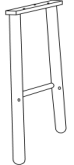
Warning : Do not stand on chair

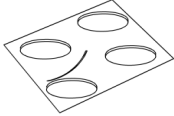
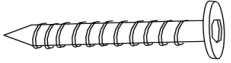
Warning : Do not over torque bolts

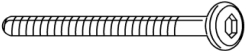
Part List and Hardware List

PIECE	DESCRIPTION	PICTURE	QUANTITY	PIECE	DESCRIPTION	PICTURE	QUANTITY
A	Chair Back With Seat		1X	HW3	Spring Washer M6		6X
B	Left Leg Frame (FL)		1X	HW4	Flat Washer M6		6X
C	Right Leg Frame (FR)		1X	HW5	Barrel Nut		4X
D	Strecher		2X	HW6	Felt Pad		4X
HW1	JCBCW x 40mm		6X	HW7	Wood Button		4X
HW2	JCBC M6 x 50mm		4X	HW8	Allen Key M4 x 110mm		1X

PREPARATION

- * Before beginning assembly of product, make sure all parts are present. Compare parts with part contents list and hardware contents list.
- * If any part is missing or damaged, do not attempt to assemble the product.
- * Estimated Assembly Time: 10 minutes.
- * Tools Required for Assembly (included): Allen Key

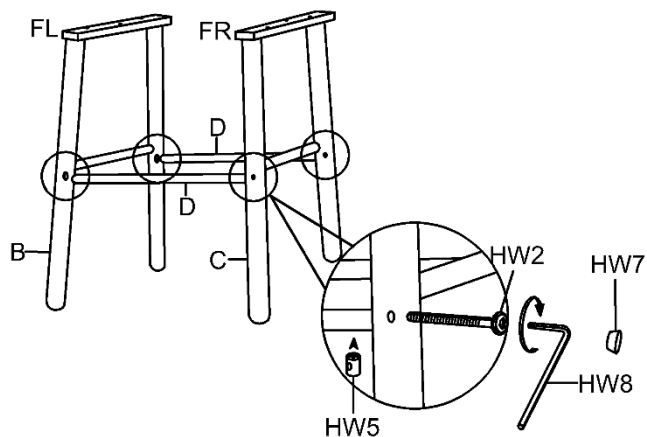

Step 1: INSERT BARREL NUT (HW5) INTO THE HOLE ON STRETCHER (D) AND INSERT THE JCBW (HW2) THEN PUT WOOD BUTTON (HW7).

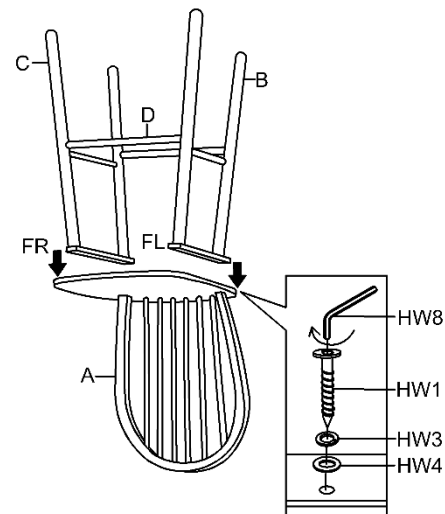

Step 2: INSERT JCBW (HW1) TO ATTACH RIGHT LEG FRAME (C) AND LEFT LEG FRAME (B) TO THE SEAT (A).

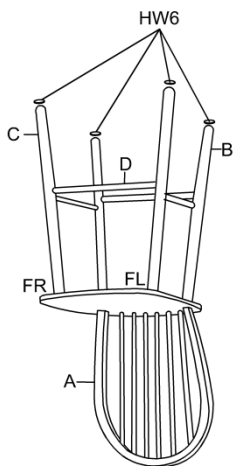

Step 3: PUT FELT PAD (HW6) ON TOP LEG.



Step 4: PUT THE CHAIR UP RIGHT AND MAKE SURE ALL LEGS ALL ARE LEVEL, THEN FIRMLY TIGHTEN BOLTS WITH ALLEN KEY (HW8) WHILE THE CHAIR IS UPRIGHT.