

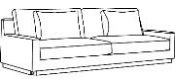





# Assembly Instructions

## WOOD, 3-SEATER BOLSTERED SOFA

Components list			Hardwares list		
Picture	Name	Quantity	Picture	Name	Quantity
 <b>A</b>	Sofa Body	1	 <b>D</b>	Bolt (M8)	8
 <b>B</b>	Leg	4	 <b>E</b>	Flat Washer	8
 <b>C</b>	Center leg	1	 <b>F</b>	Sprung Washer	8
			 <b>G</b>	Allen key	1

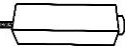

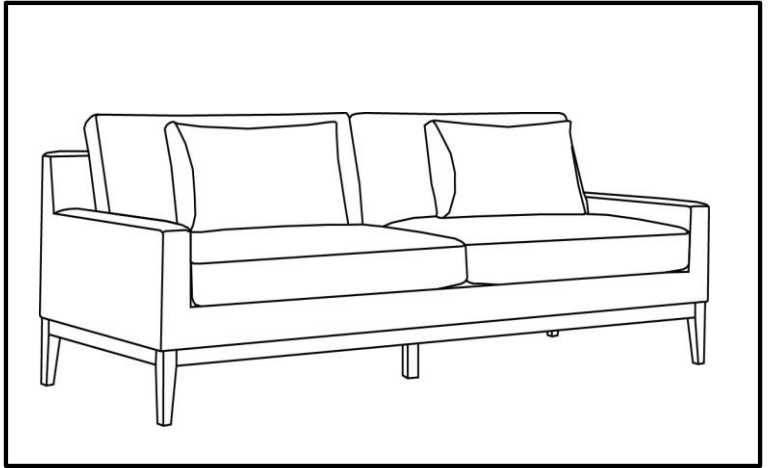
**TWO PERSONS NEED TO ASSEMBLE THIS ITEM**

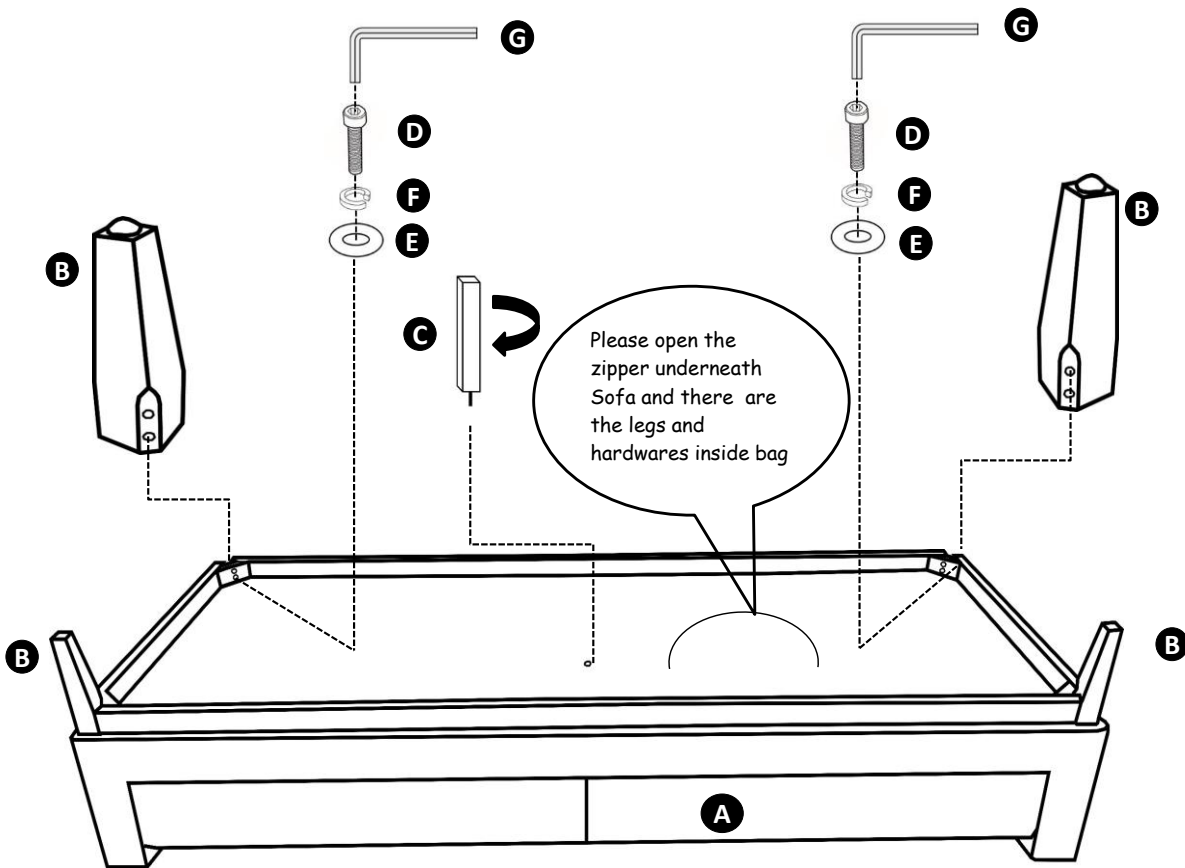

**Please Note:**

1. We suggest you spend a short time reading through this leaflet and then follow the simple steps by step instructions.
2. Don't discard any of the packaging until you have checked that you have all the parts and the pack of fittings.
3. Assemble the this item on a clean carpet/mat/surface.
4. We strongly advise that all the fittings are only finger tightened during initial assembly only, upon completion of the assembly should all fittings points be fully tightened.
5. We strongly recommend a period check on all fixing points to make sure they remain fully tightened.
6. Keep away from direct sunlight.