

ASSEMBLY INSTRUCTION

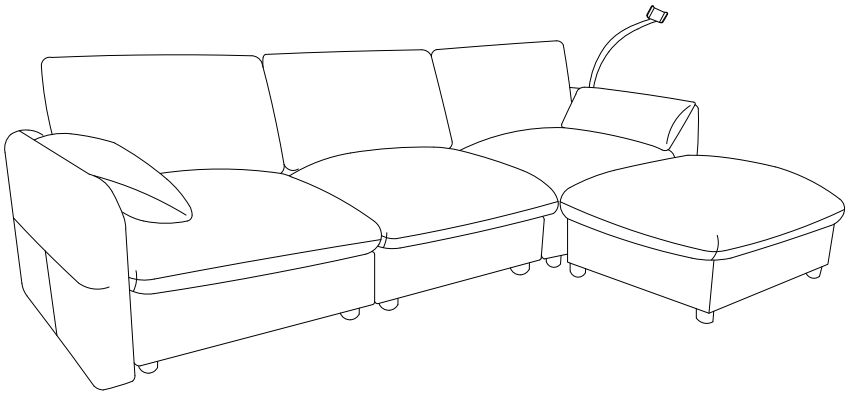

Sets often ship in multiple boxes and delivery date may vary.

CUSTOMER SERVICE

**Questions, Missing parts, Assembly help?
No need to return the product, we will gladly help and ship
your replacement parts free of charge.**

PRE-ASSEMBLY INFORMATION

Please read this manual carefully before beginning assembly of this product. Keep this manual for future reference.

NOTICE

1. Please assemble it AFTER all boxes are received.
2. Please do not throw away any of the packages or the instruction until the sofa is fully assembled.
3. Please keep children away from the plastic bags or any small pieces of stuff.
4. Some key parts of our product may be stored and hidden inside of other parts. Please open any zippered or hook & loop storage compartments to take out all parts.
5. Please do not open the compressed packages until your sofa frame is completely assembled.
6. As the cushions are all vacuum compressed, there will be some wrinkles. Please give them up to 72 hours to reach its original size and the wrinkles will basically disappear.
7. DO NOT INSTALL THE SCREWS ALL THE WAY IN THE BEGINNING. Place each screw into their proper hole and use your hand to twist the screw halfway. Twist all the screws in halfway to ensure the holes will match up properly and the product is level on the ground. When everything seems fitted, then tighten the screws.
8. Do not over tighten screws and bolts to avoid stripping.



2 adults recommended



Takes about 1.5 Hours to assemble



Weight capacity of each seat: 330LBS

COMPONENTS

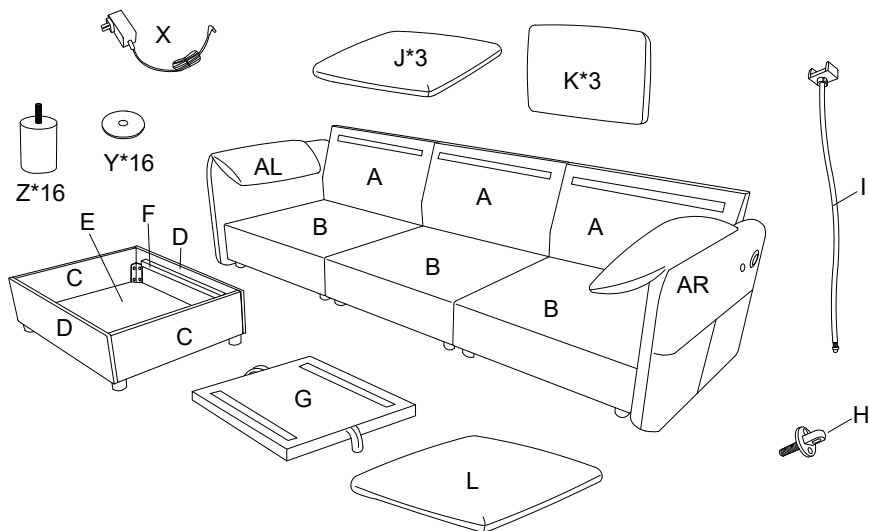

HARDWARE

NO	DESCRIPTION	SKETCH	QTY
①	Double-headed screws M8*90		6
②	Nuts M8		6
③	M8 Nut wrench		1
④	Screws 6*40mm		12
⑤	Nuts M6		4
⑥	Leg irons		4
⑦	Screws 6*15mm		16
⑧	Wrench		1
⑨	Self-tapping screw		2
⑩	Phillips screwdriver		1

COMPONENTS

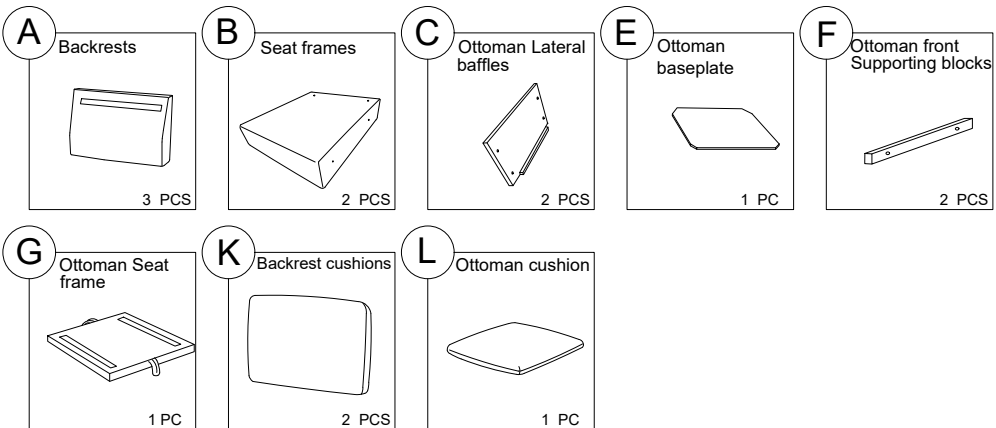
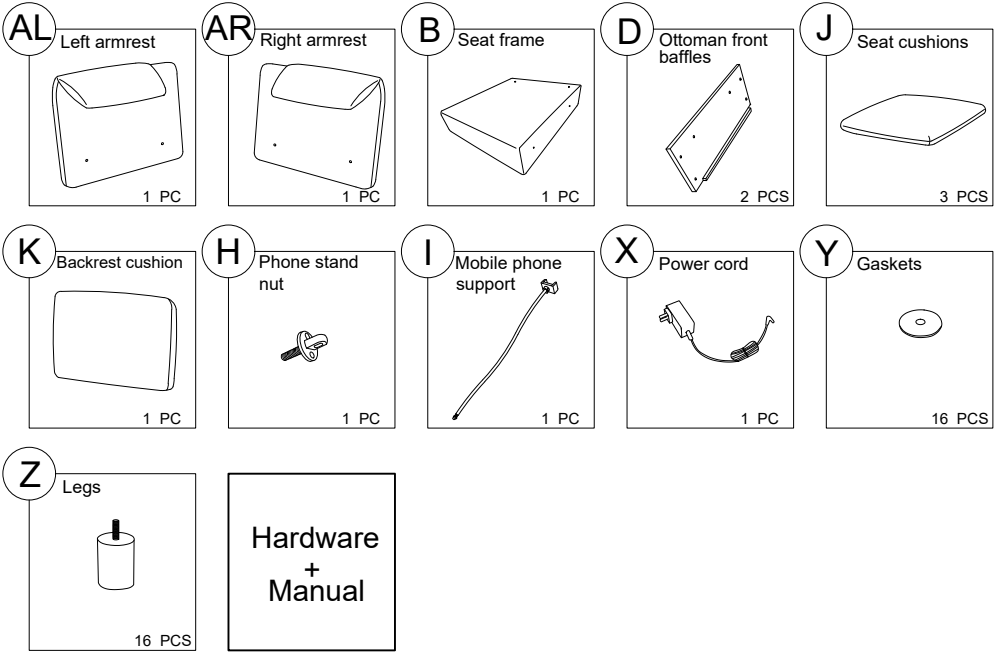

STEP 1 Install double-headed screws ① onto backrests (A).

①×6 

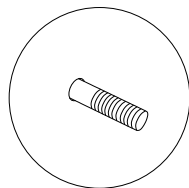
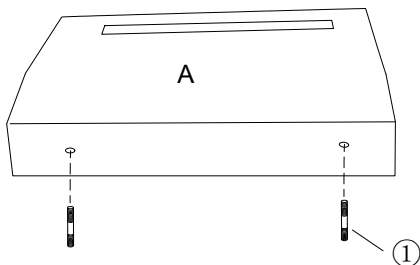

In place

STEP 2 Use M8 Nut wrench ③ and nuts M8 ② to link the seat frame (B) and backrests (A).

②×6 

③×1 

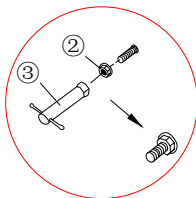
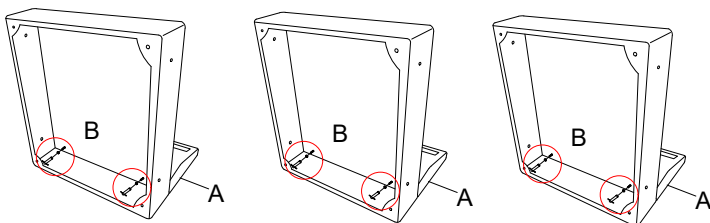

STEP 3 Install left armrest (AL) / right armrest (AR) on seat frame (B) with screws 6*40mm ④ by wrench ⑧.

④×4 

⑧×1 

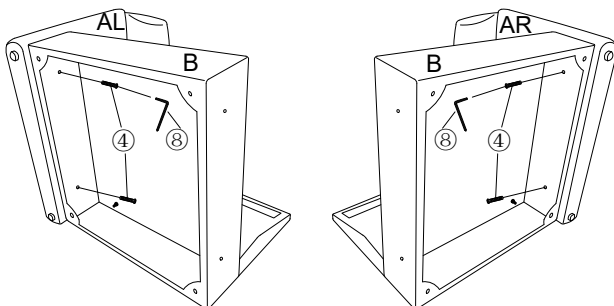

STEP 4 Use wrench ⑧, nuts M6 ⑤ and screws 6*40mm ④ to link the seat frames.

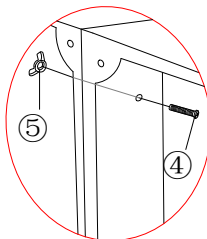
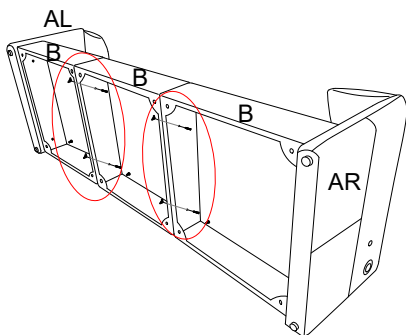

④×4	
⑤×4	
⑧×1	

STEP 5 Use screws 6*15mm ⑦ to link leg irons ⑥ to ottoman front baffles (D), then tighten the screws with a wrench ⑧. (Note that the screws in this step can only be tightened 70%)

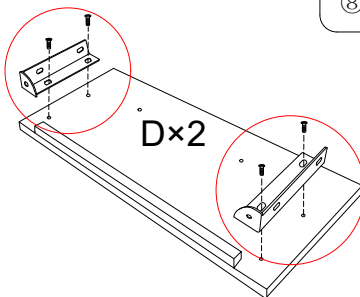
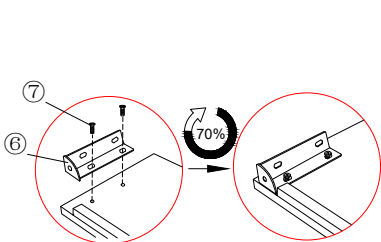

⑥×4	
⑦×8	
⑧×1	

STEP 6 Use screws 6*15mm ⑦ to link leg irons ⑥ to ottoman lateral baffles (C), then tighten the screws on the ottoman front baffles (D) and ottoman lateral baffles (C) with a wrench ⑧.

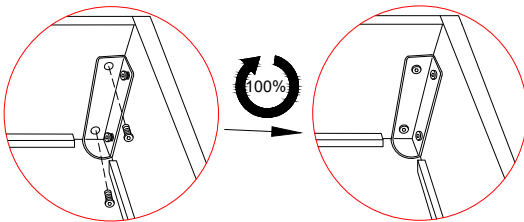
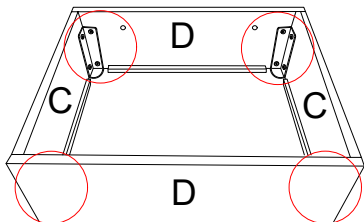

⑦×8	
⑧×1	

STEP 7 1.Place Ottoman baseplate(E) in the installed Ottoman seat frame.

2.Use Screws 6*40mm ④ to link ottoman front supporting blocks(F)to ottoman front baffles(D). Tighten the screws with a wrench.

④×4



⑧×1

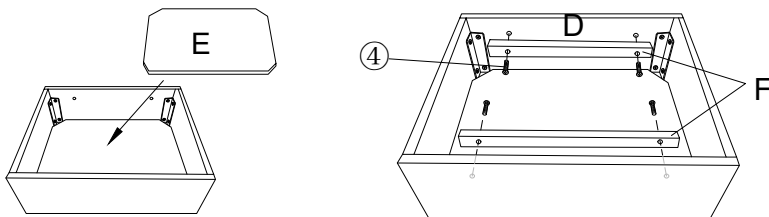

STEP 8 Attach legs (Z) and Gaskets (Y) to the seats.

Y×16



Z×16

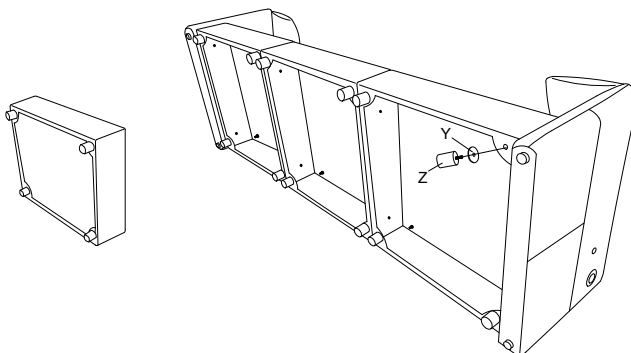

STEP 9

Open the vacuum bag and take the Backrest cushions(K), Seat cushions/OttomanSeat cushion(J/L) out. To restore the original shape, follow the steps below.

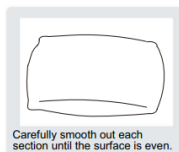
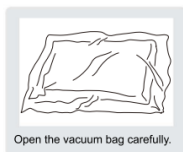

After packing up, place them in somewhere dry and ventilated. After about 72-96 hours. It can be restored to the best use condition.

STEP 10

1. Install the phone stand nut (H) onto right armrest (AR).
2. Use self-tapping screws (9) to link the phone stand nut (H) to right armrest (AR).
3. First, remove the screw cap that comes with part Mobile phone support (I), and then insert the bracket into the handrail and screw the cap back on.

⑨×2

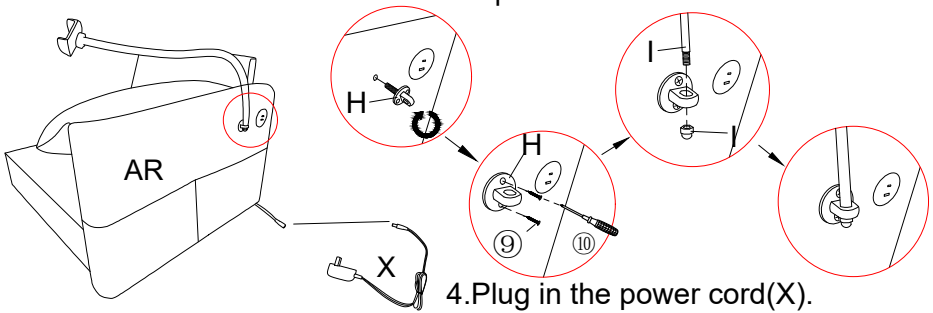

⑩×1

**STEP 11**

Put the cushions on the sofa

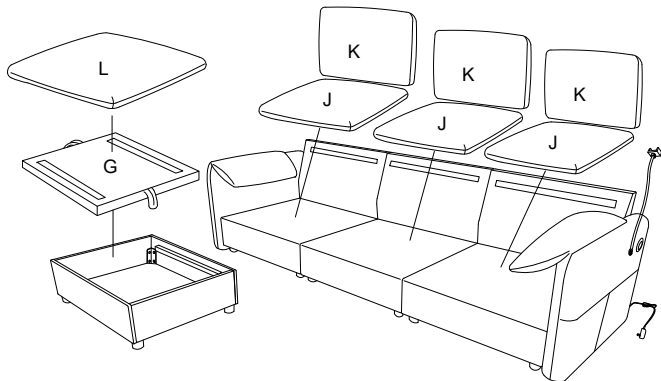
**STEP 12 Complete**