

ASSEMBLY INSTRUCTIONS

Dining Chair

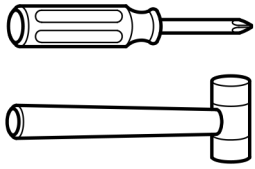

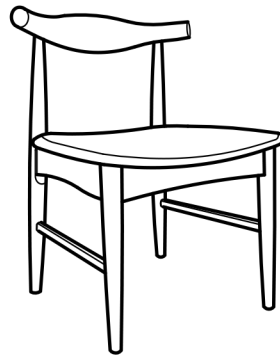

Not Provided

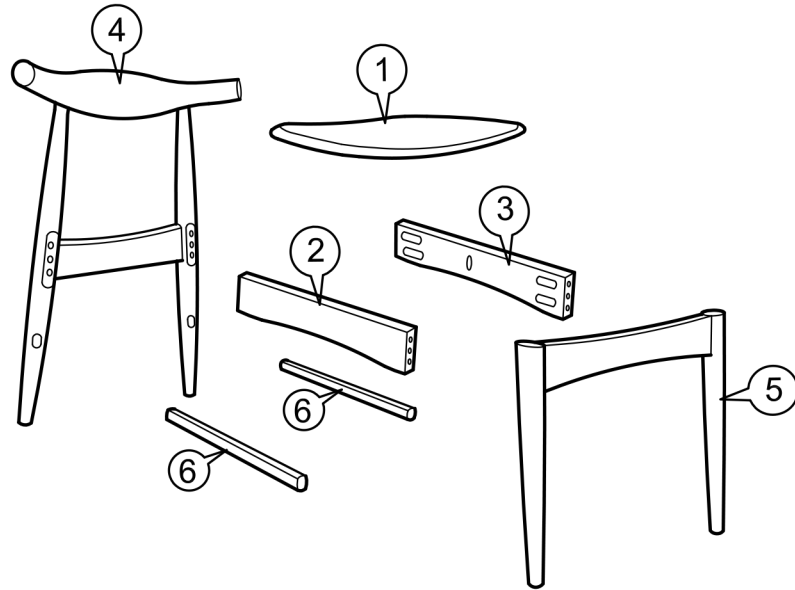
Part List :

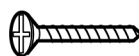
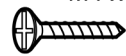
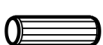

Hardware List

A M6 x 50mm = 16 	B 5/16" = 16 	C M4 x 38mm = 8 	D M4 x 32mm = 12 
E M8 x 30mm = 8 	F M4 x 110mm = 1 