





# ASSEMBLY INSTRUCTION

## 1-DRAWER NIGHTSTAND

<b>A</b> Top  1PC	<b>B</b> Leg  4PCS	<b>C</b> Flat Washer Ø5/16"*19mm  8PCS	<b>D</b> Lock Washer Ø5/16"*13mm  8PCS
<b>E</b> Bolt 5/16", 3/4"  8PCS	<b>F</b> Allen Wrench 9mm  1PC		

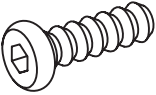
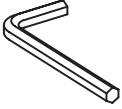
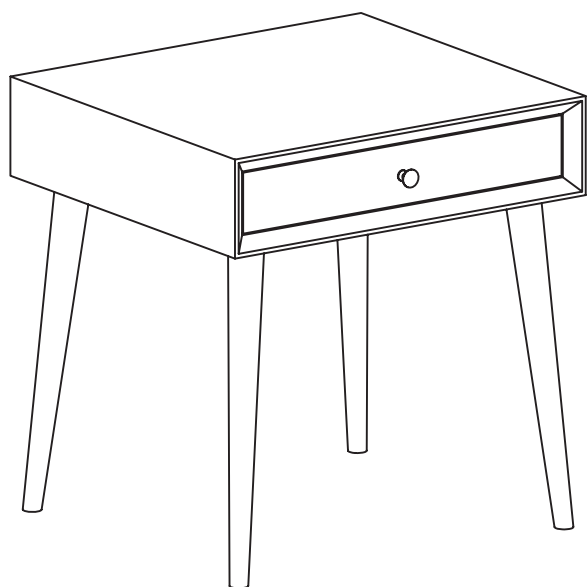

This page lists all the contents included in the box. Please take the time to identify the hardware as well as the individual components to this product. As you unpack and prepare for assembly, place the contents on a carpeted or padded area to protect them from damage.

- 1** Attached the Legs (B) to the Table Top (A). Use Bolt (E), Lock Washer (D) and Flat Washer (C), on holes of Legs (B). Turn the Allen Wrench (F) in Bolt (E).

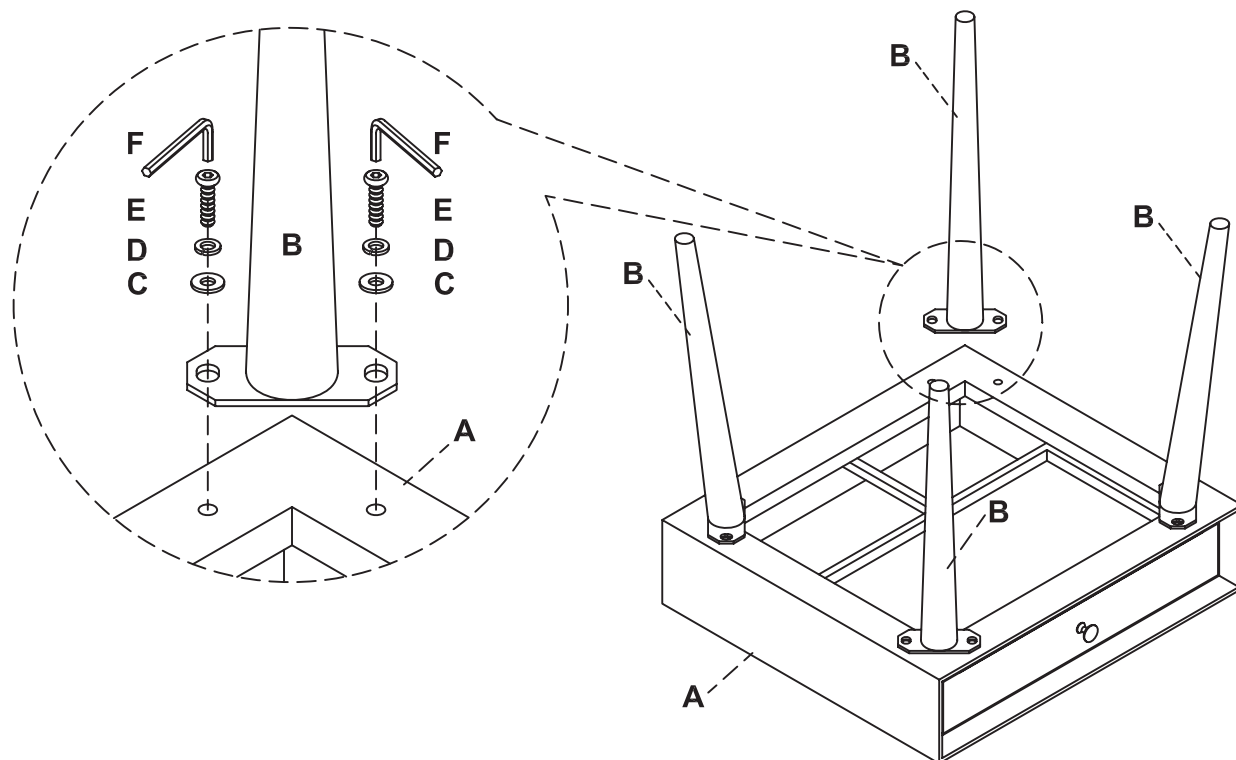

- 2** Complete assembly.



### Cleaning & Care

Treat surface with care. Surface is resistant to scratches but is not scratch resistant. Clean surface with a dry or damp soft cloth. Do not use abrasive cleaners. Hardware may loosen over time. Periodically check that all connections are tight.