

Recreational Trampoline

User Manual

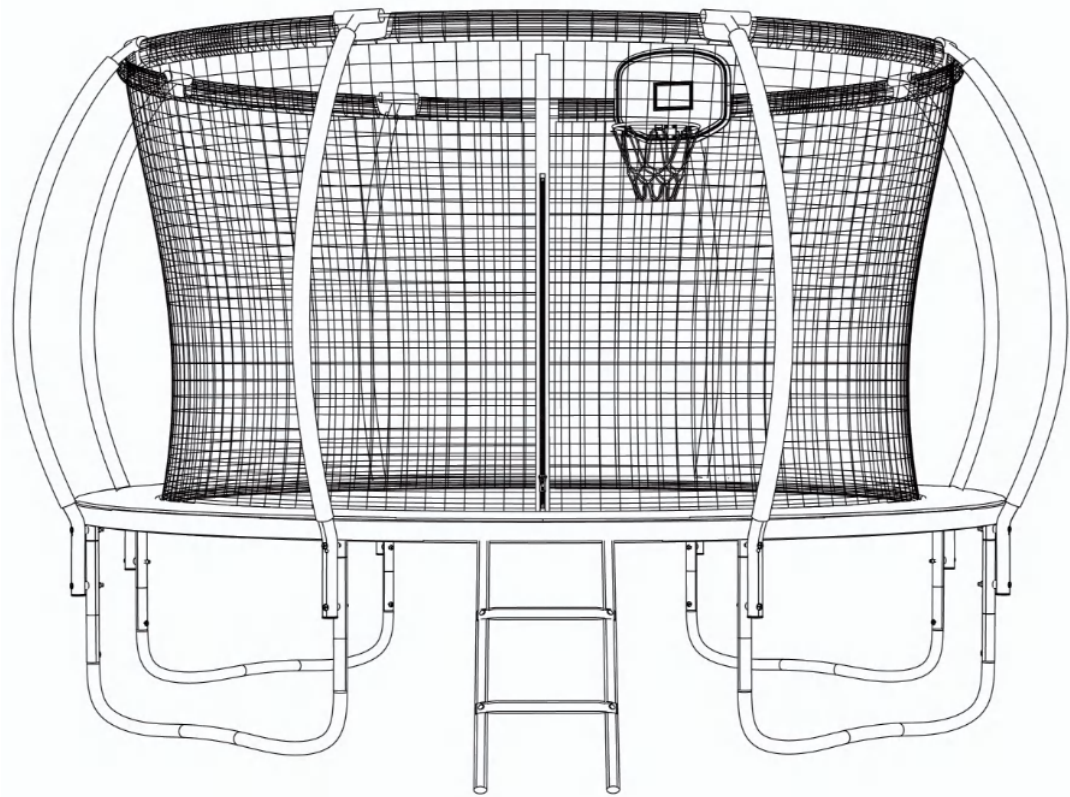

CONTENTS

Using Instructions	02-04
Additional Safety Warning	05-08
Trampoline Parts List	09-10
Installation Instructions	11-20
Maintenance and Care	21-22

GENERAL SAFETY WARNING

Thank you for choosing our recreational trampolines! For the best user experience and safety, please make sure to thoroughly and carefully review this user manual before assembling and using the product, and keep it for future reference. Similar to physical sports and activities, there's always a risk of participants sustaining injuries. To safeguard your future enjoyment and prevent any potential harm, it's crucial to adhere to the relevant safety rules and tips.

Do not use the trampoline without adult or knowledgeable supervision, regardless of your skill level or age.

ALWAYS CHECK YOUR TRAMPOLINE BEFORE USE. PAYING SPECIFIC ATTENTION TO ALL THE BOLTS, JUMP MAT AND PADS POSITION. DON'T USE IF ANY PARTS ARE MISSING OR DISPLAY SIGNS OF WEAR AND TEAR.

Using Instructions

1. The Weather Conditions, Environment, and Storage Method for the Trampoline

- Avoid using the trampoline when it's wet or during windy conditions, as high winds can potentially cause it to blow away. In case of windy weather, relocate the trampoline to a sheltered area or secure it using ropes and stakes. For safety, use a minimum of three straps to fasten the round outer part (top frame) of the trampoline to the ground.
- Only bounce on the trampoline when the mat surface is dry, and ensure the wind or air movement is calm or gentle. Avoid using the trampoline in gusty or severe winds for safety.
- Avoid using the trampoline in heavy rain as it can make the jumping surface extremely slippery, posing safety risks.

2. Requirements for Trampoline Installation, Site, and Handling



Please make sure at least 2 people install the trampoline.

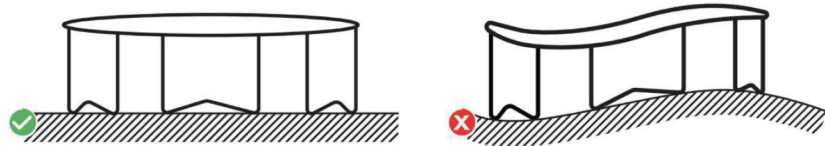

Ensure the trampoline is positioned and installed on level ground. An uneven ground surface could lead to warping of the trampoline frame.

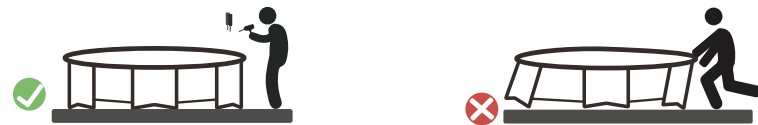

Ensure that all the bolts securing the frame joints are fully tightened before installing the springs. Do not push against the trampoline leg or frame.



Please install the springs diagonally to ensure even tension and prevent issues with subsequent spring installation.

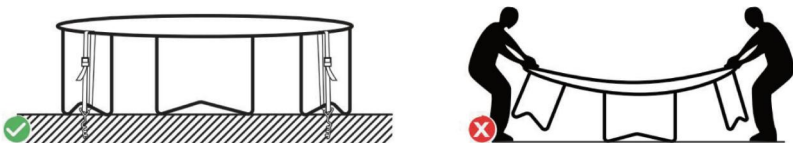

If the trampoline and enclosure need to be moved, it should be done by at least two people, keeping it horizontal, and lifting it slightly. For added safety, make sure to wrap and secure all connection points with weather-resistant tape, such as duct tape. This will help keep the frame intact during the move and prevent the connection points from shifting or separating.

3. Dress Requirements for Trampoline Use

- Select clothing without drawstrings, hooks, or loops that could potentially cause entanglement or pose suffocation risks while using the trampoline.
- When using the trampoline, it's important to wear appropriate clothing, preferably sportswear and socks. NEVER WEAR SHOES ON THE MAT.
- It's advisable to remove glasses, watches, bracelets, necklaces, and any other items that could easily fall off.

4. Physical Examination

- Always consult a doctor/physician prior to engaging in any physical activity.
- Do not use the trampoline while under the influence of alcohol or drugs.

5. Other Instructions for Use

- Somersaults and flips are strictly prohibited, as landing on the head or neck may result in severe injury, paralysis, or even fatality, even if landing in the center of the mat.
- The trampoline should be assembled on grass or BSI-approved safety matting.
- Trampolines over 20in (51cm) tall are not recommended for children under 6 years old.
- Stop exercising immediately if you feel unwell or experience pain in your joints and muscles. If you feel dizzy, a sign of fatigue, stop bouncing and have a good rest.
- If a trampoline ladder is utilized, the supervisor should remove it from the trampoline when not in use to prevent unsupervised access by children under 6 years old.
- Do not use the trampoline without adult or knowledgeable supervision, regardless of your skill level or age.
- Before each use, carefully inspect the trampoline for bent tubes, a torn mat, loose or broken springs, and check the overall stability.
- Do not use the trampoline as a springboard. Do not get off by jumping off the trampoline and landing on the ground, even if it's a grassland.
- Avoid reckless or prolonged bouncing on the trampoline, as it heightens the risk of injury.
- Ensure that all jumpers adhere to the weight limit when playing on the trampoline. Always jump in the middle of the mat and practice bouncing techniques safely under adult supervision and guidance.
- Never put any items on the trampoline while someone is playing, and ensure there are no activities taking place beneath it. Always securely close the safety net before anyone starts jumping.
- Ensure that any potential obstructions are kept away from the trampoline to prevent interference with the jumper.
- Do not use the trampoline when it is wet, damaged, dirty, or worn out, and refrain from using it as a device for bouncing onto or into another object.
- Keep the safety enclosure tightly fastened to the trampoline in accordance with the manufacturer's instructions. Do not attach anything to the safety enclosure that is not a manufacturer-approved accessory or part.
- Learn fundamental bounces and body positions thoroughly.
- Avoid bouncing too high. Maintain control.
- Ensure that the trampoline is properly secured when not in use to prevent unsupervised and unauthorized usage.
- For skill training information, contact a trainer certification organization.

! ADDITIONAL SAFETY WARNING



Somersaults are strictly prohibited, as landing on the head or neck can result in severe injury, paralysis, or even fatality, even if landing in the center of the mat.



Do not allow more than one person on the trampoline or inside the trampoline enclosure. Used by more than one person at the same time may result in serious injury.



Do not jump with sharp objects in your hands or pockets.



Do not attempt to jump over the enclosure net.



Do not intentionally rebound off the enclosure net or hang from, kick, cut, or climb on it.



Do not jump from high ledges into the trampoline and avoid dangerous tricks.



Do not use the trampoline if there are obstructions underneath the jumping mat.



Do not exceed weight limit.

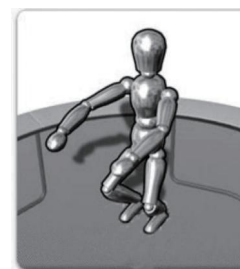

BEFORE YOU TRY TO JUMP TOO HIGH: It's important to learn the technique for stopping. It's recommended to land with bent knees, allowing them to absorb the spring of the mat. This position is shown in the image on the left. Additionally, extending the arms can enhance balance.

This technique is employed when the trampoline user intends to stop bouncing, whether due to fatigue, loss of control, or any other reason.



FOREIGN OBJECTS: Do not use the trampoline if there are pets, children, or any objects beneath it. Refrain from holding any foreign objects in your hand or placing items on the trampoline while in use. Additionally, avoid positioning the trampoline under overhanging objects such as tree branches or wires, etc. As these conditions heighten the risk of potential injuries.

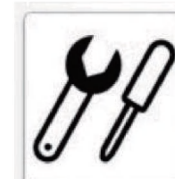

POOR MAINTENANCE: A trampoline in poor condition will raise the risk of injuries. Before each use, please inspect the trampoline for bent steel tubes, a torn mat, loose or broken springs, and ensure overall stability.



WEATHER CONDITIONS: Please be aware of weather conditions when using the trampoline. A wet mat may cause slips and injuries, while strong winds can lead to loss of control.



RESTRICTING ACCESS: When the trampoline is not in use, securely store the access ladder to prevent unsupervised children from playing on the trampoline.

▲ RISK OF ACCIDENTS

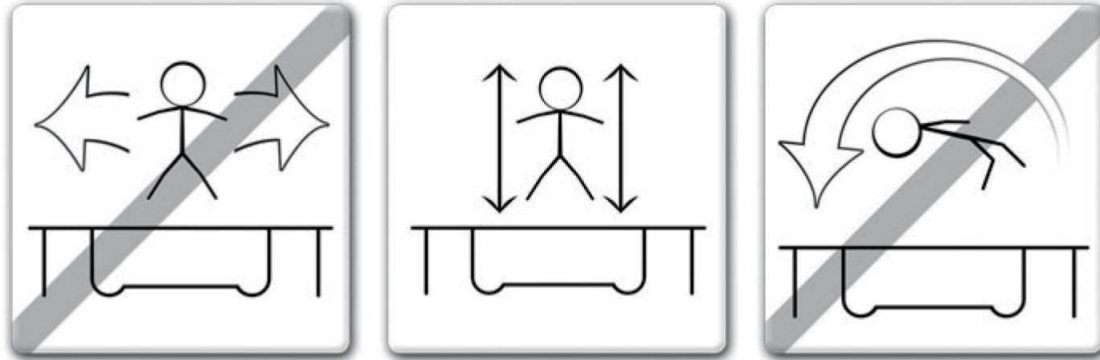

In order to reduce the risk of accidents, the Trampoline User should:

- Maintain control of their jumps and body position at all times.
- Not attempt skills beyond their own competence level.
- Understand the jump by taking off and landing in the middle of the trampoline.
- Always control their jump by taking off and landing in the middle of the trampoline.
- Always jump vertically and refrain from bouncing towards the springs in any direction.
- Always consult a professionally certified trampoline instructor before attempting anything beyond basic techniques.

In order to reduce the risk of accidents, the Supervisor should:

- Fully understand and enforce all the safety rules and guidelines.
- Guide the trampoline user, offering feedback on their actions to ensure their safety and well-being.
- Be aware and advise the trampoline user of all safety warnings.













Note: If the trampoline cannot be supervised, there should be a method to secure it, preventing anyone from using the product until supervision is available.





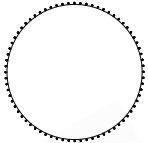
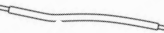













▲ SAFETY INSTRUCTIONS GUIDE

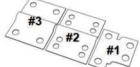

- Avoid using the trampoline after consuming alcohol or narcotic substances.
- Climb on and off the trampoline in a controlled manner. Avoid jumping onto or off it and refrain from using it to bounce onto or into other objects.
- Master the basic bounce before attempting more difficult types.
- To stop your bounce, flex your knees upon landing.
- Maintain control at all times while bouncing. Stop bouncing immediately if you feel out of control.
- Avoid prolonged or excessively high jumping sessions. Keep focus on the mat to retain control and prevent imbalance.
- Do not allow more than one person on the trampoline to minimize the risk of injuries.

Trampoline Parts List

RECREATIONAL TRAMPOLINES		8FT	10FT	12FT	14FT	16FT	
1		Upper Net Pole	5pcs	7pcs	7pcs	11pcs	11pcs
2		Longer Upper Net Pole	1pc	1pc	1pc	1pc	1pc
3		Frame Tube	6pcs	8pcs	8pcs	12pcs	12pcs
4		T-shaped Connector	6pcs	8pcs	8pcs	12pcs	12pcs
5		U-shaped Leg	3pcs	4pcs	4pcs	6pcs	6pcs
6		Leg Extension Tube	6pcs	8pcs	8pcs	12pcs	12pcs
7		Philip's Head Screws	6pcs	8pcs	8pcs	12pcs	12pcs
8		Spring	48pcs	64pcs	72pcs	84pcs	108pcs
9		Spring Loading Tool	1pc	1pc	1pc	1pc	1pc
10		Jumping Mat	1pc	1pc	1pc	1pc	1pc
11		Lower Net Pole	6pcs	8pcs	8pcs	12pcs	12pcs
12		Long Screw	12pcs	16pcs	16pcs	24pcs	24pcs
13		Pad Spacer	12pcs	16pcs	16pcs	24pcs	24pcs
14		Nut	12pcs	16pcs	16pcs	24pcs	24pcs

15		Carbon Fiber Rod	6pcs	8pcs	8pcs	12pcs	12pcs
16		Frame Cover	1pc	1pc	1pc	1pc	1pc
17		Safety Enclosure Net	1pc	1pc	1pc	1pc	1pc
18		Ladder	1pc	1pc	1pc	1pc	1pc
19		Ladder Screw	4pcs	4pcs	4pcs	4pcs	4pcs
20		Nut	4pcs	4pcs	4pcs	4pcs	4pcs
21		Washer	4pcs	4pcs	4pcs	4pcs	4pcs
22		Wrench	1pc	1pc	1pc	1pc	1pc
23		Phillips Screwdriver	1pc	1pc	1pc	1pc	1pc
24		Rope	1pc	1pc	1pc	1pc	1pc
25		Basketball Backboard	1pc	1pc	1pc	1pc	1pc
26		Basketball Rim	1pc	1pc	1pc	1pc	1pc
27		Mounting Bracket	3pcs	3pcs	3pcs	3pcs	3pcs
28		Flat Round Head Inner Hexagon Screw	4pcs	4pcs	4pcs	4pcs	4pcs
29		Hexagon Head Bolt	4pcs	4pcs	4pcs	4pcs	4pcs
30		Nut	4pcs	4pcs	4pcs	4pcs	4pcs
31		Washer	12pcs	16pcs	16pcs	24pcs	24pcs
32		T-shaped Connector for Carbon Fiber Rod	5pcs	7pcs	7pcs	11pcs	11pcs
33		Connector Tube for Carbon Fiber Rod	1pc	1pc	1pc	1pc	1pc

Installation Instructions

Ensure you have a spacious, clean, and dry area suitable for assembling the trampoline. It's crucial that the installation site is entirely flat and level. Please ensure that at least two people are involved in installing the trampoline and use protective gloves to avoid injury during assembly.

1. Frame and Legs Installation

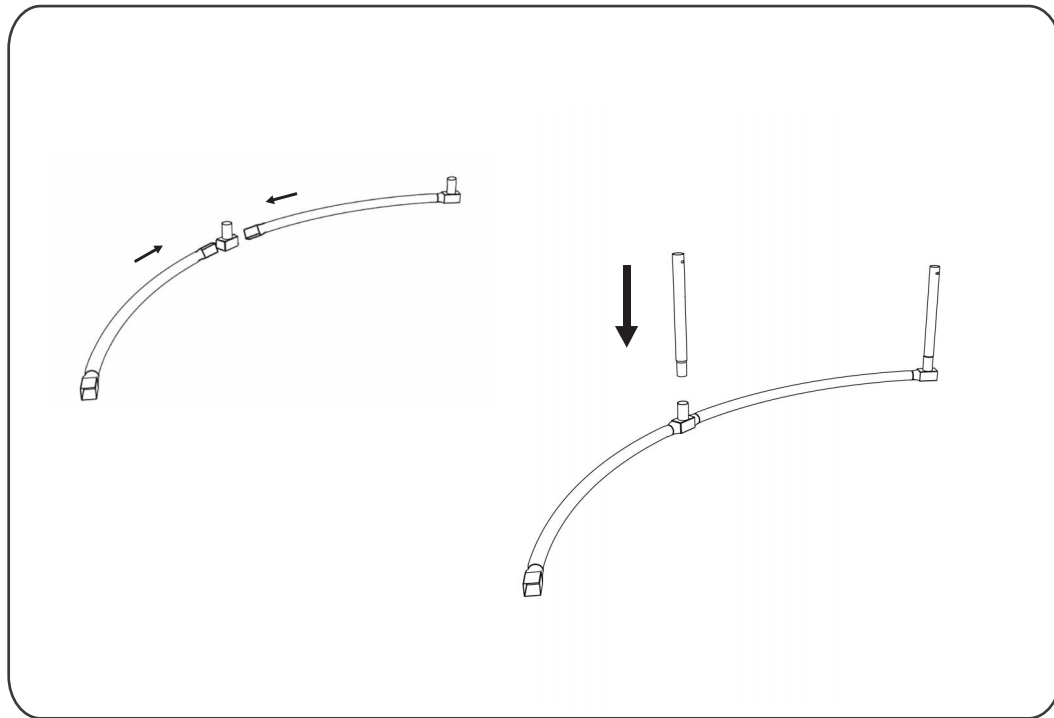

Step 1. Assemble the T-shaped connectors to the frame tubes first, then assemble every two frames tubes; next, respectively insert the leg extension tubes into the T-shaped connectors of the frames tubes.

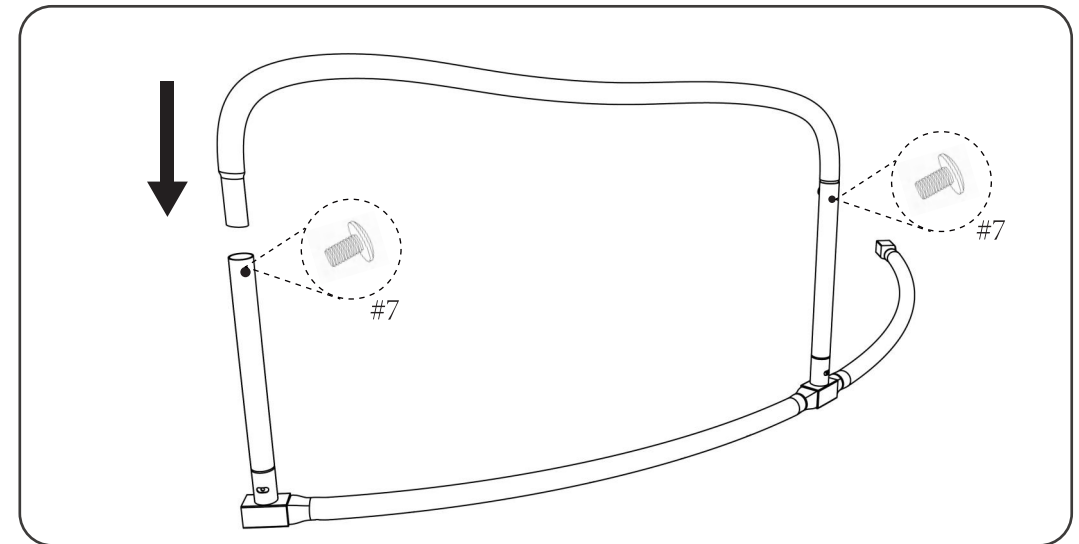

Step 2. Respectively install the U-shaped legs onto the leg extension tubes, align the screw holes, screw in the Philip's head screws and securely tighten them.

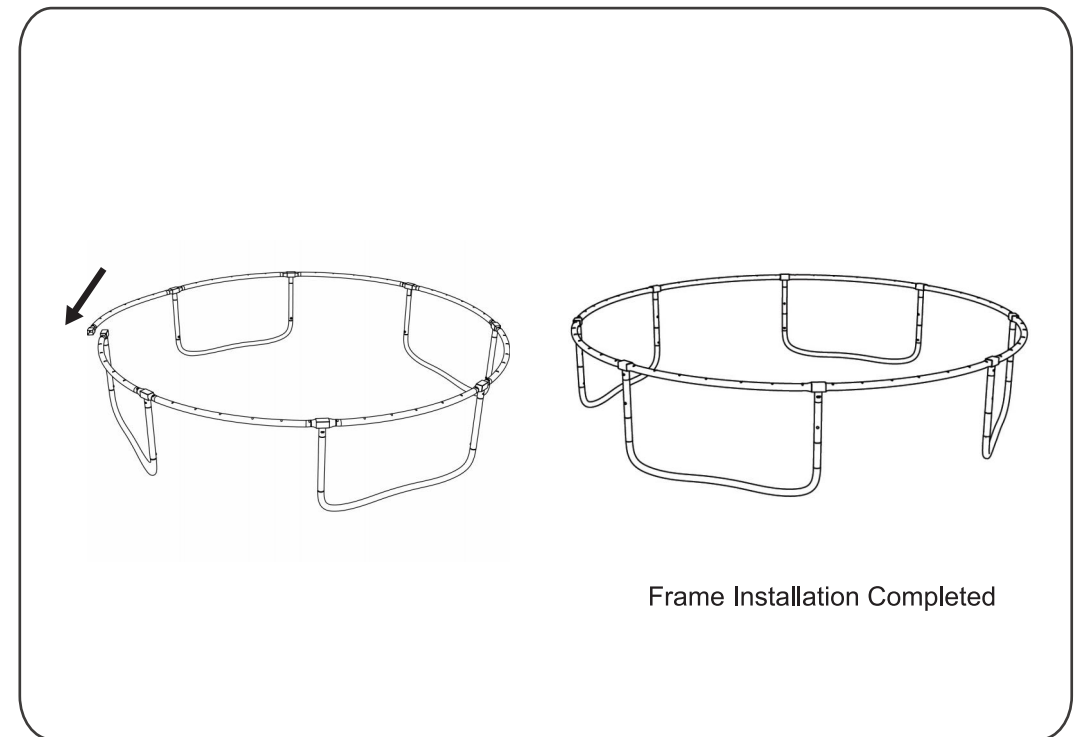

Step 3. Assemble all the frame tubes.

2. Jumping Mat and Frame Cover Installation

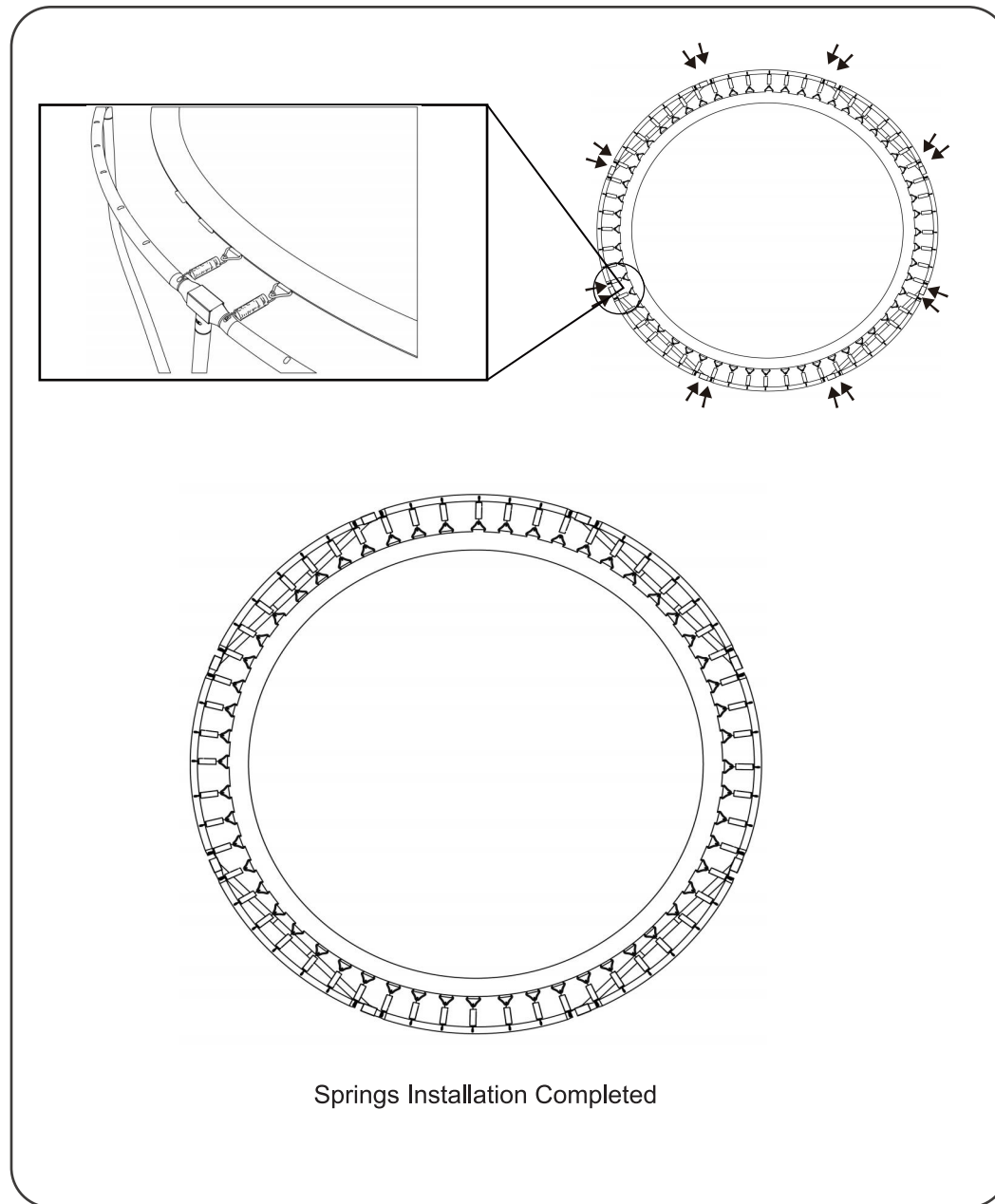

Step 4. Lay the jumping mat flat inside the frame, then attach it to the frame using springs. Ensure the initial attachment to the two sides of the T-shaped connectors on the frame, then install the springs diagonally to ensure even tension and prevent issues with subsequent springs installation, for example, begin at the 12 o'clock position and then at 6.

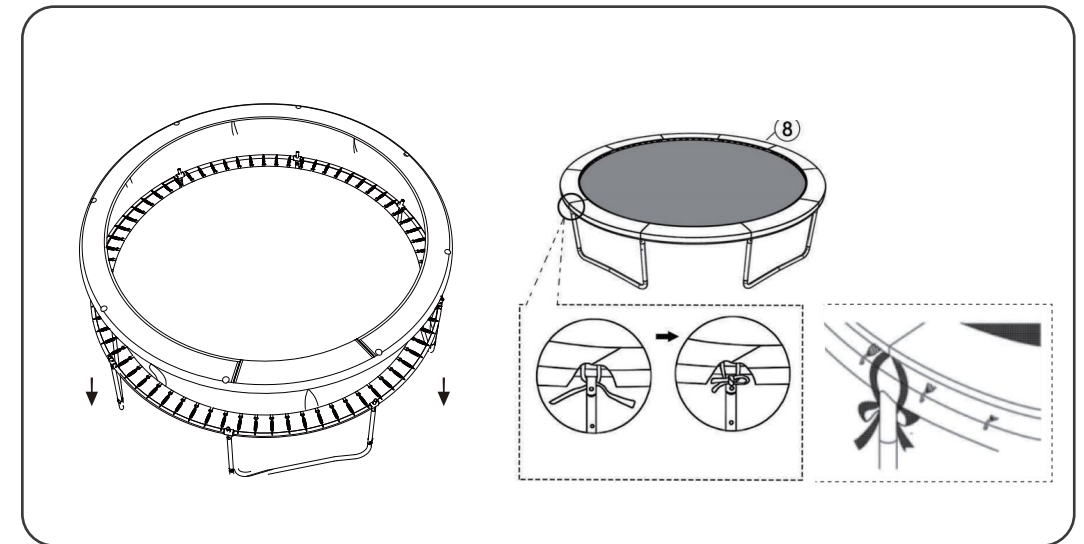

Step 5. Lay the frame cover over the springs, and tie the straps to the steel tubes.

3. Safety Enclosure Net and Protecting Poles Installation

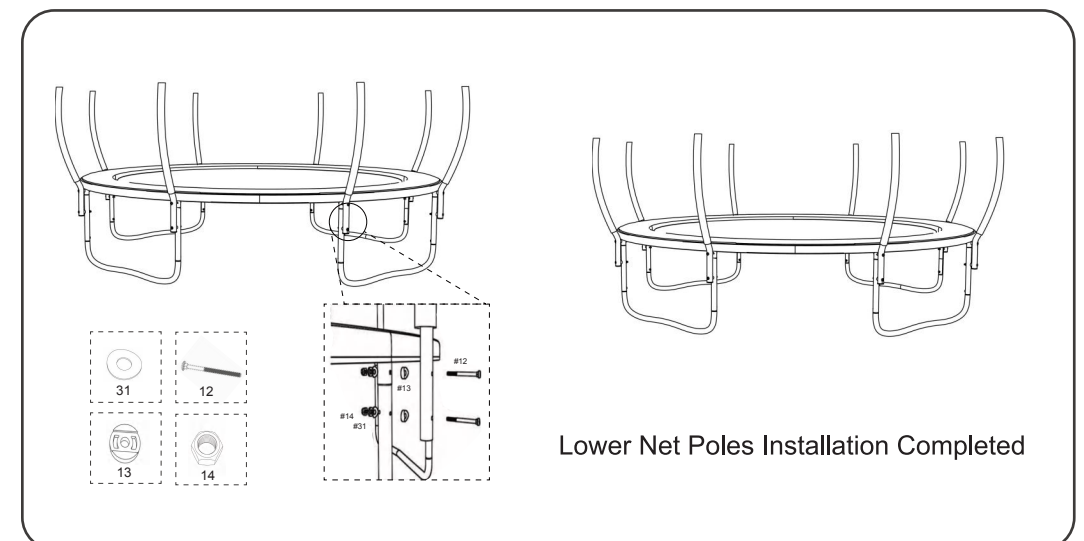

Step 6. Install the lower net poles to the upper end of the leg extension tubes using long screws, pad spacers, nuts and washers.

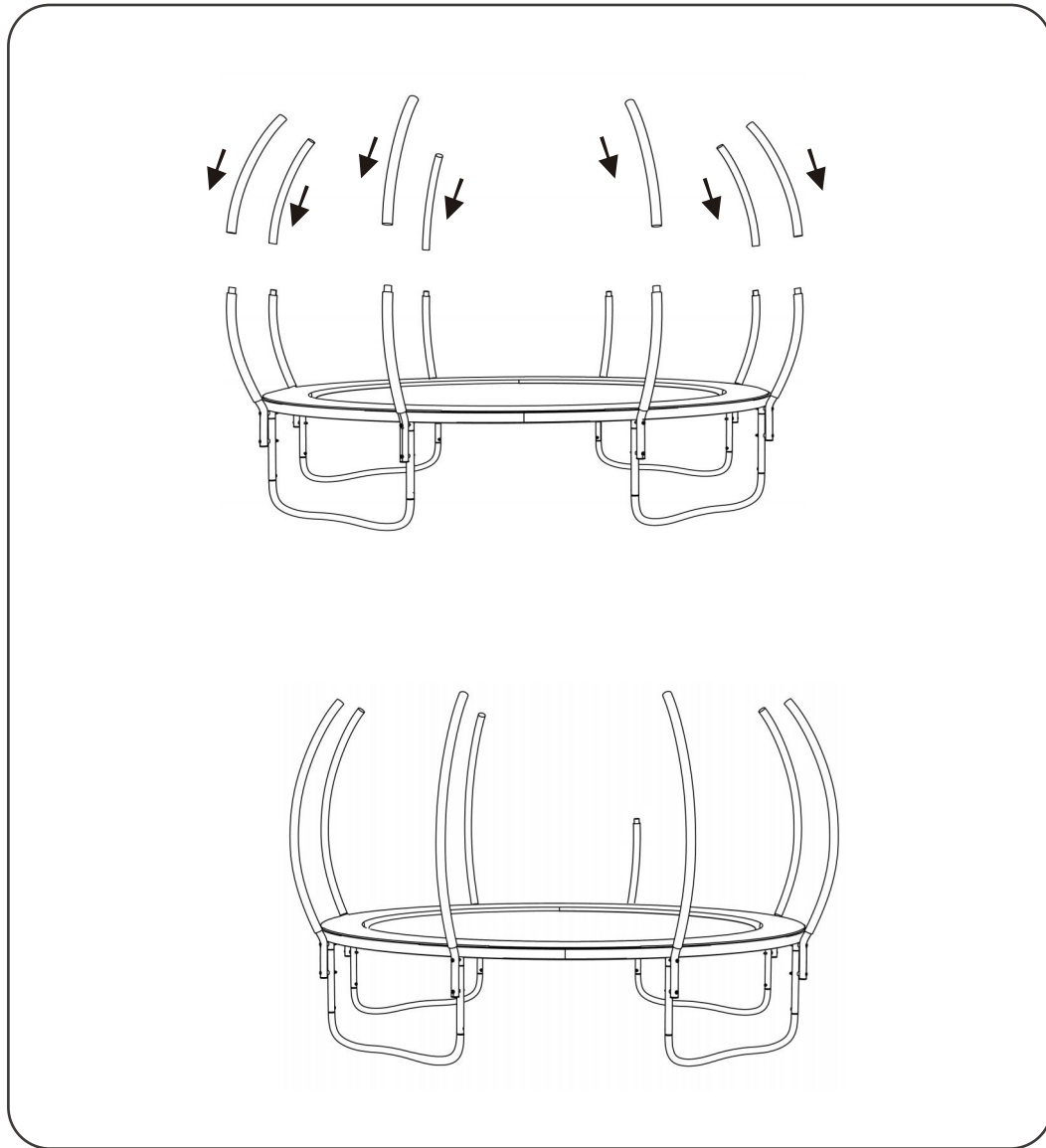

Step 7. Connect the upper net poles to the lower net poles, but not the longer upper net pole, as the longer one is used to install the basketball backboard. In addition, the basketball backboard should be installed right opposite the opening of the safety enclosure net!

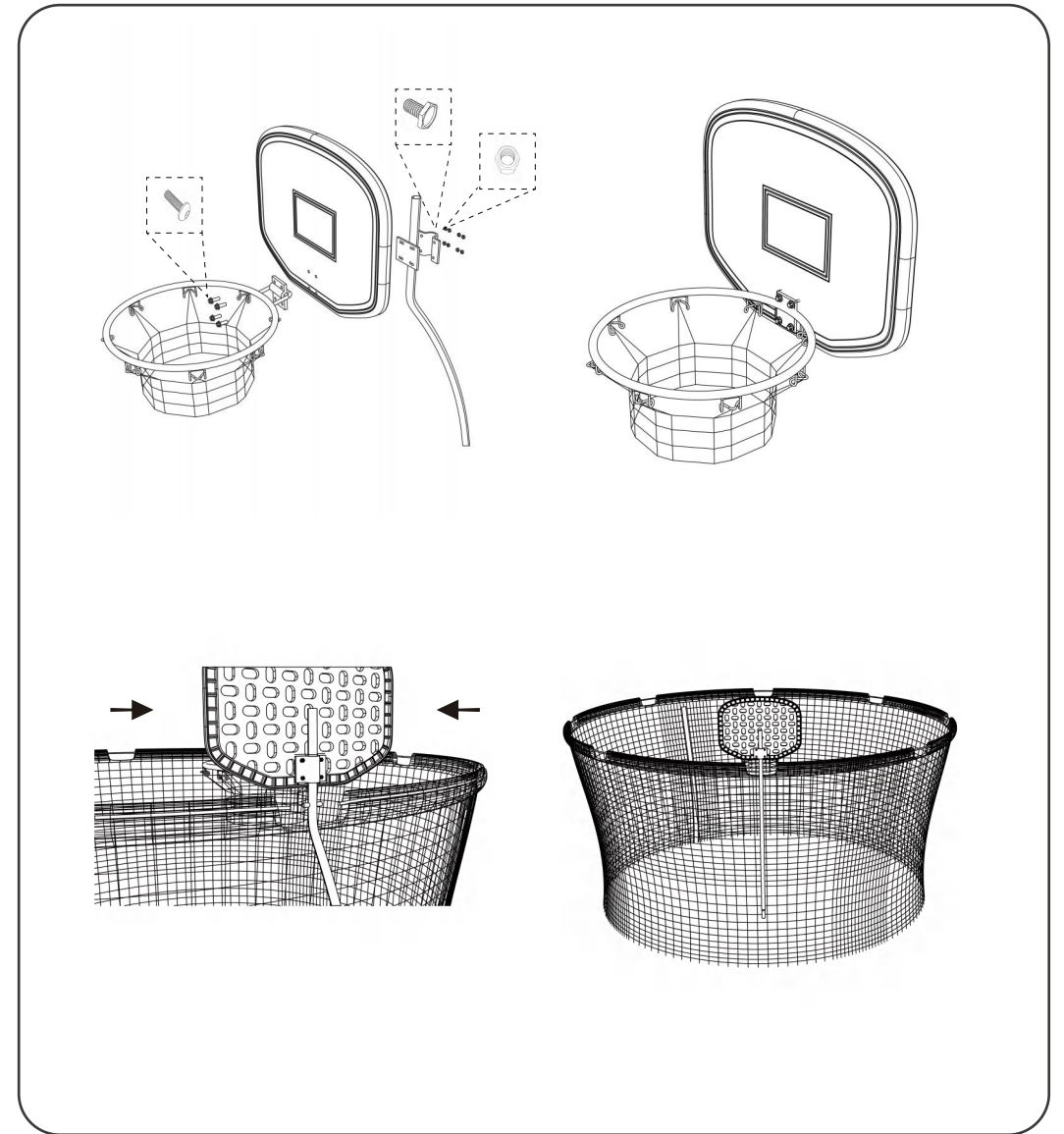

Step 8. Assemble the basketball backboard and rim using the #1 mounting bracket and flat round head inner hexagon screws; install the longer upper net pole to the back of the backboard using #2 and #3 mounting brackets, hexagon head bolts and nuts; then, insert the connector tube for the carbon fiber rod into the hole of the longer upper net pole.

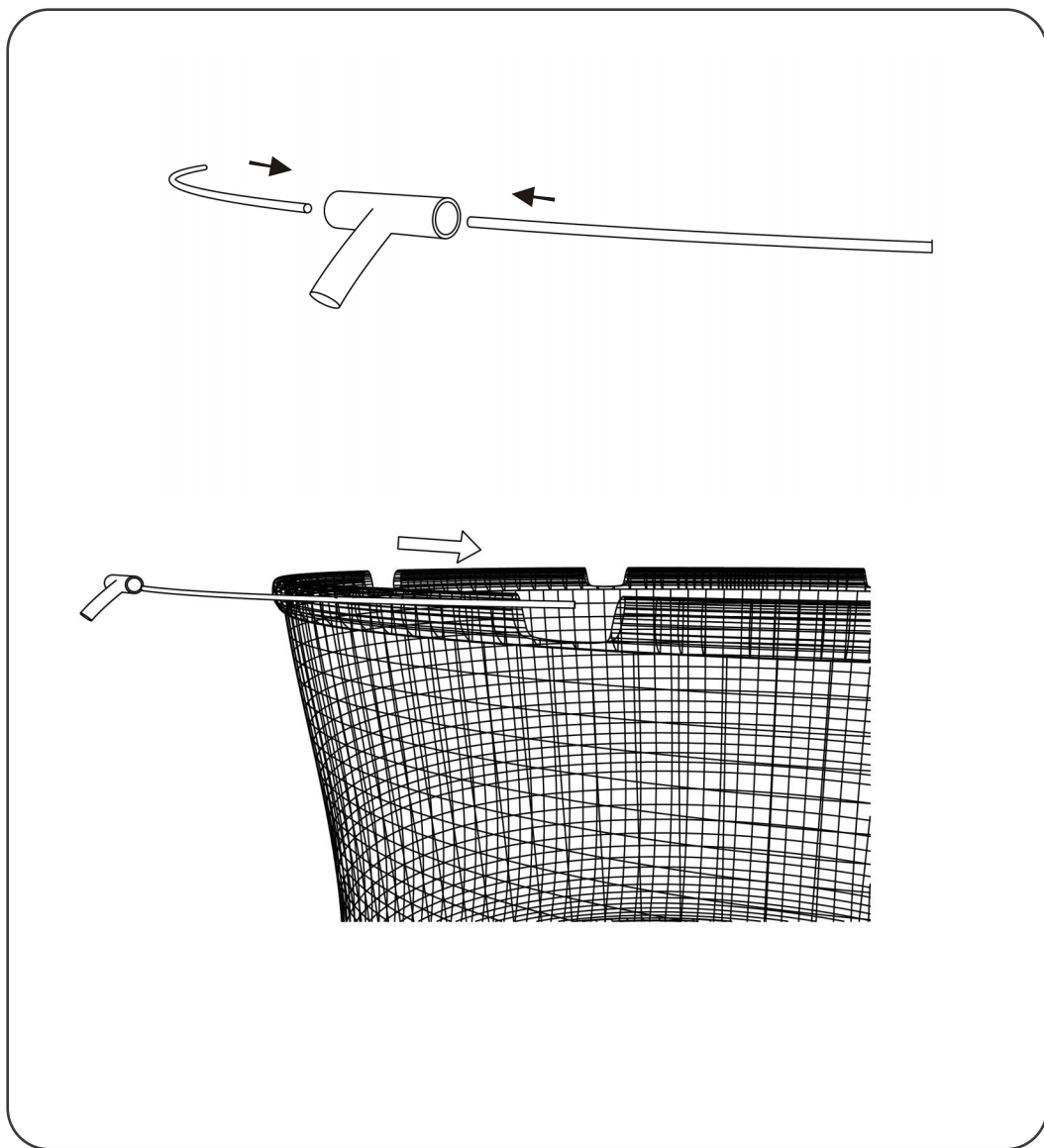

Step 9. Thread the carbon fiber rods through the top opening of the safety enclosure net to assemble it, and connect each two carbon fiber rods using the T-shaped connectors and connector tube.

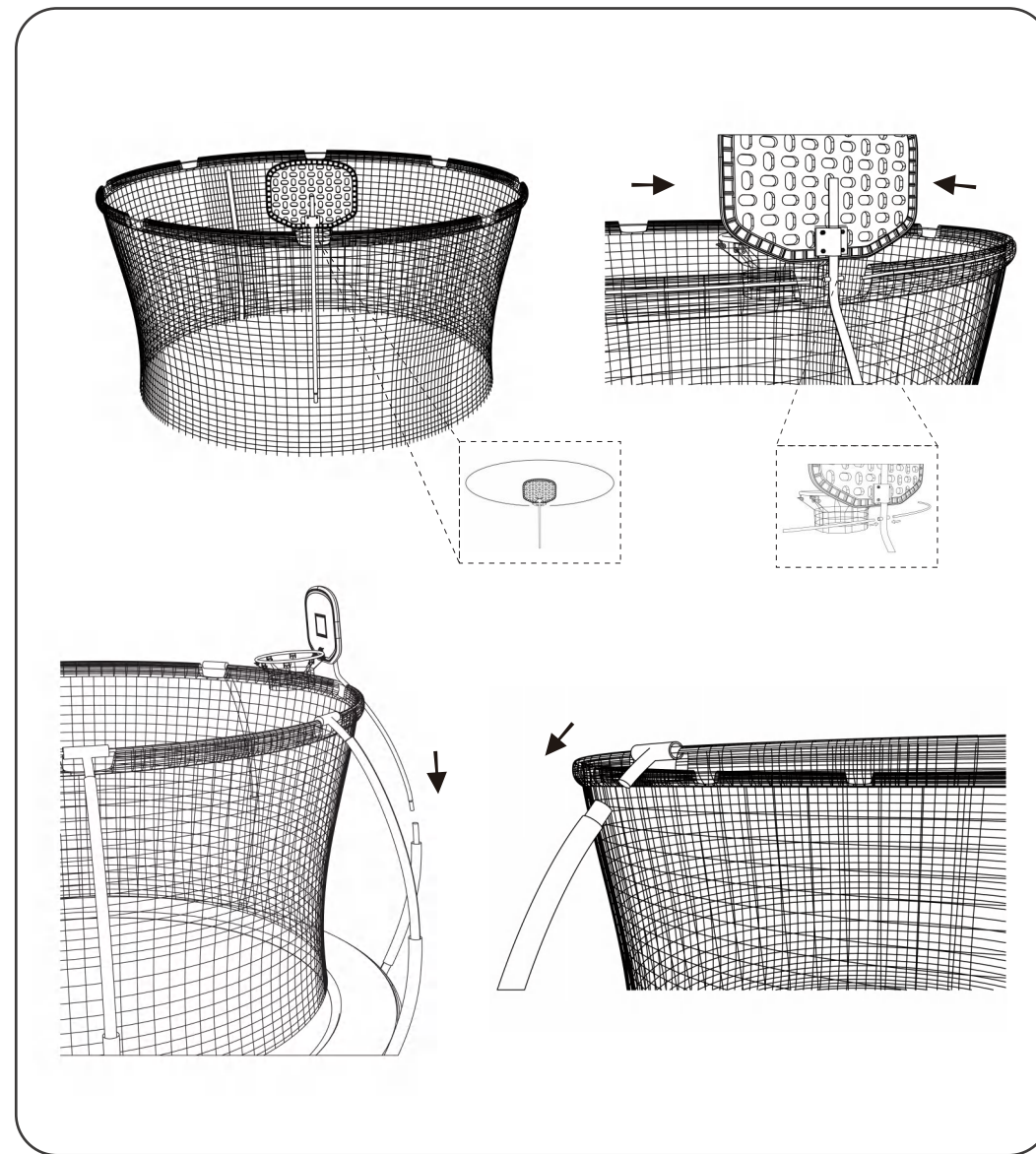

Step 10. Connect the longer upper net pole to the lower net pole, and then install the safety enclosure net by inserting the T-shaped connectors for the carbon fiber rod into the upper net poles.

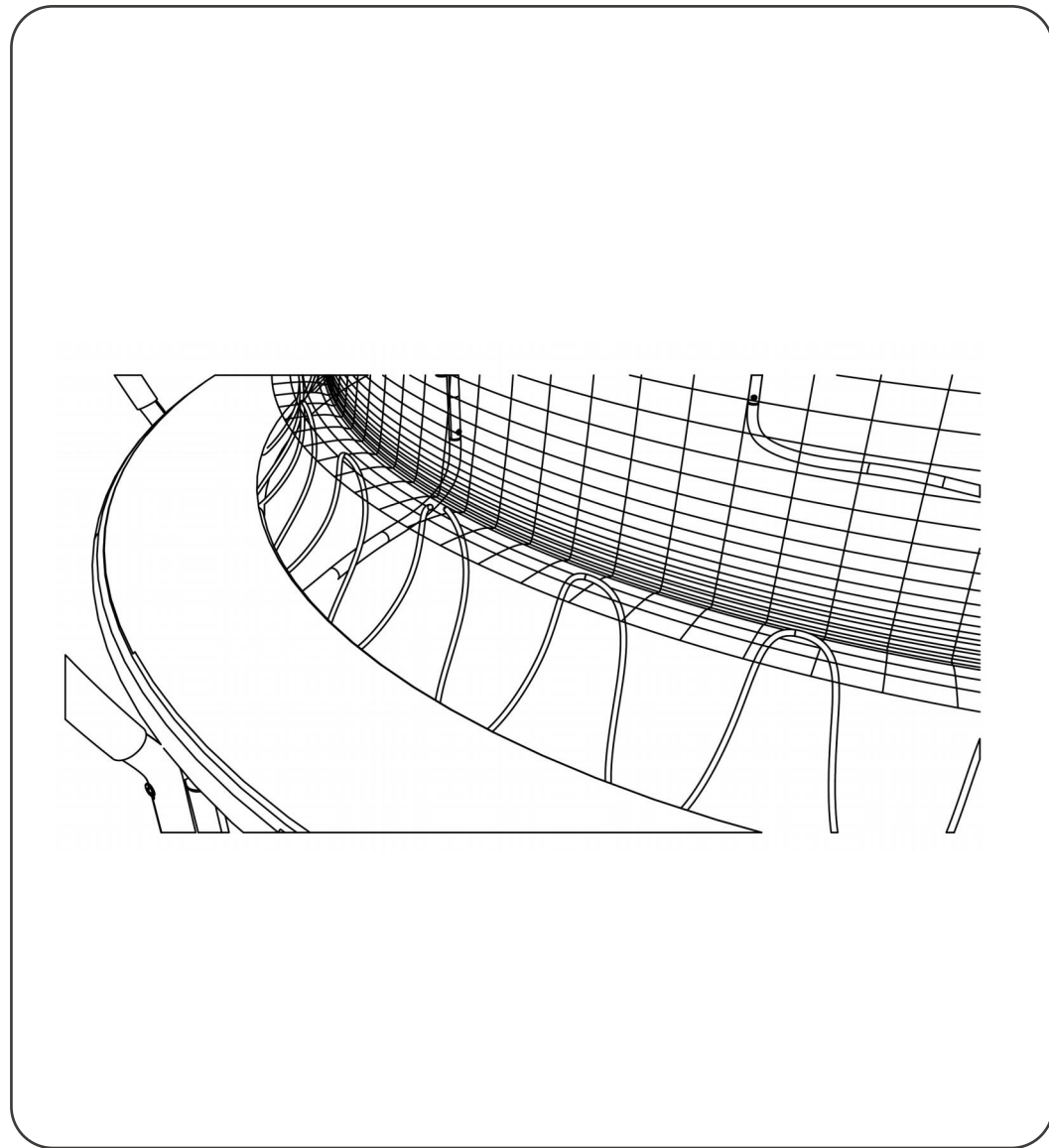

Step 11. Thread the rope alternatively through the bottom opening of the safety enclosure net and the V-rings on the jumping mat until completed. Finally, tighten and secure the rope in place.

4. Ladder Installation

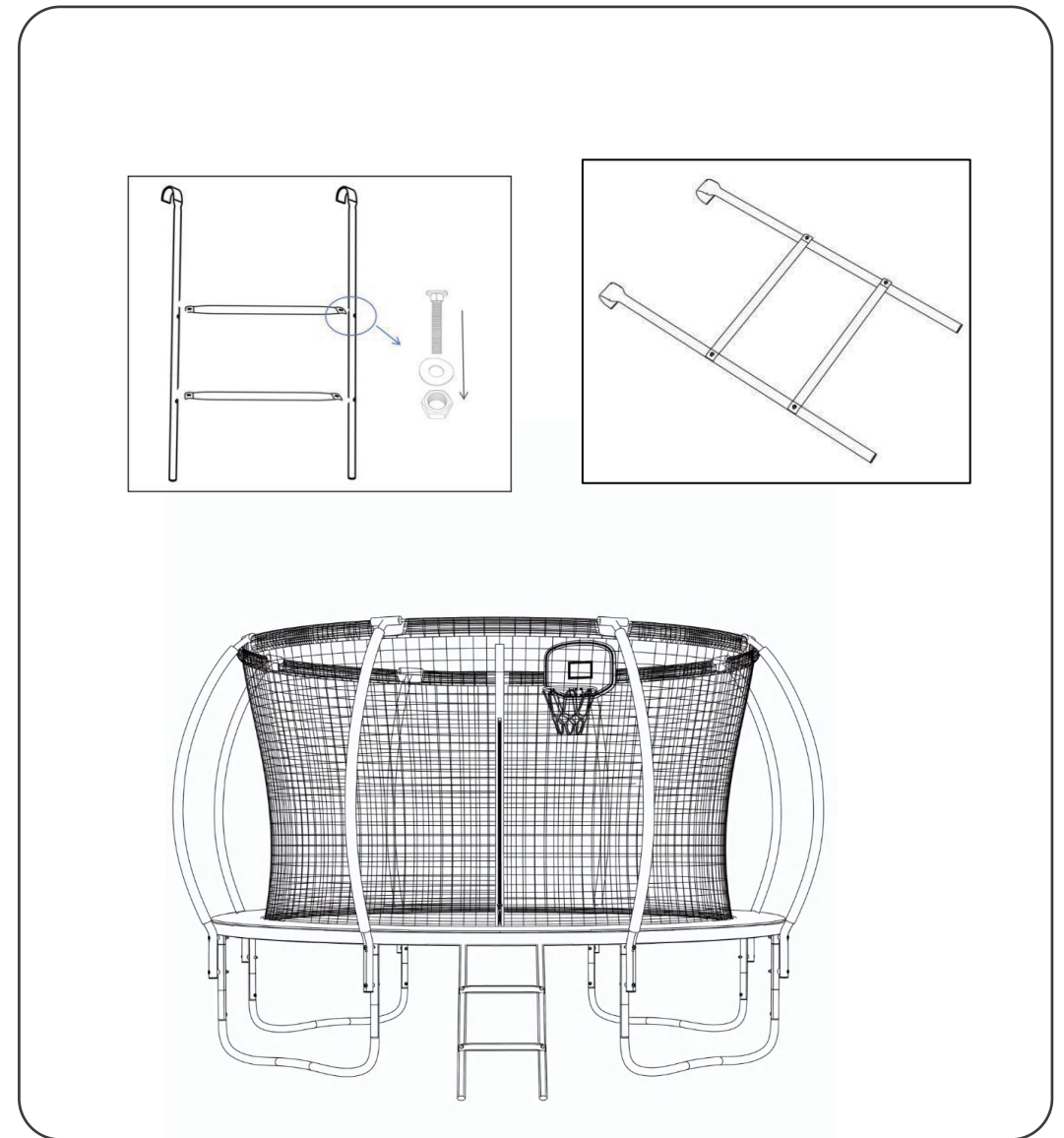

Step 12. Assemble the ladder using the ladder screws, nuts and washers, and then install the ladder to the frame tube below the safety enclosure net exit. Congratulations! Assembly is now complete!

Maintenance and Care

Performing regular maintenance and providing proper care will help prolong the lifespan of the trampoline and decrease the risk of potential injuries.

Trampoline Inspection

Before each use, it is crucial to inspect the trampoline and replace any components that are worn, defective, or missing. The following conditions may present potential hazards:

- Missing, improperly positioned, or insecurely attached frame padding.
- Puncture, frays, tears, or holes worn in the jumping mat or frame padding.
- Deterioration in the stitching or fabric of the mat or frame padding.
- Sharp protrusions on the frame or suspension system.
- Ruptured springs.
- A bent or broken frame.
- A sagging mat.

Jumping Mat Inspection

The only thing between the jumper and the ground is the mat. If a deteriorated mat is not inspected properly, further jumping may cause the mat to detach from the straps over a large area, leading to the risk of the jumper landing on the ground and sustaining serious injuries. Therefore, if any deterioration is found, all bouncing must stop immediately, and the trampoline should either be disassembled or made inaccessible to prevent use until the issue is resolved. The following conditions may represent potential hazards:

- Broken stitching along the mat's edge.
- Rotten or frayed fabric around the V-ring straps.

Safety Enclosure Net Inspection

Before each use, inspect the trampoline enclosure net and replace any worn, damaged, or missing parts. The following conditions may represent potential hazards:

- Missing, improperly positioned, or loosely attached enclosure net or frame padding and pole caps.
- Punctures, frays, tears, or holes in the enclosure net or frame padding.
- Sharp protrusions on the frame or suspension system.
- Deterioration in the stitching or fabric of the enclosure net or frame padding.
- A bent or broken frame.
- A sagging enclosure net.

Extreme Cold Weather Protection

Our trampolines are designed for year-round outdoor use. However, in climates with cold weather where snow and ice are common, we recommend removing and storing the trampoline mat, springs, frame pad, and net in a dry area out of the sun. To disassemble, simply follow the installation instructions in reverse order.

Care

Regularly inspect, clean, and wash your trampoline mat with a garden hose every two weeks.

- Before using the trampoline, ensure there are no sharp objects, leaves, debris, mildew, or bird droppings on it.
- Jumpers should either wear socks or be barefoot when using the trampoline.
- Keep your trampoline away from potential fire sources, such as a grill.
- Do not allow pets or animals to access the jumping area.
- Store the trampoline in a dry area with good ventilation when it's not in use.
- Using the rain cover to protect the trampoline from UV damage, or other potential issues.
- Using the rain cover can help keep your trampoline clean and prevent leaves or bird droppings from accumulating on the mat when you move the trampoline to a sheltered area (note that at least two adults are required when removing it).