

ASSEMBLY INSTRUCTIONS

1 Door with Shelf WC

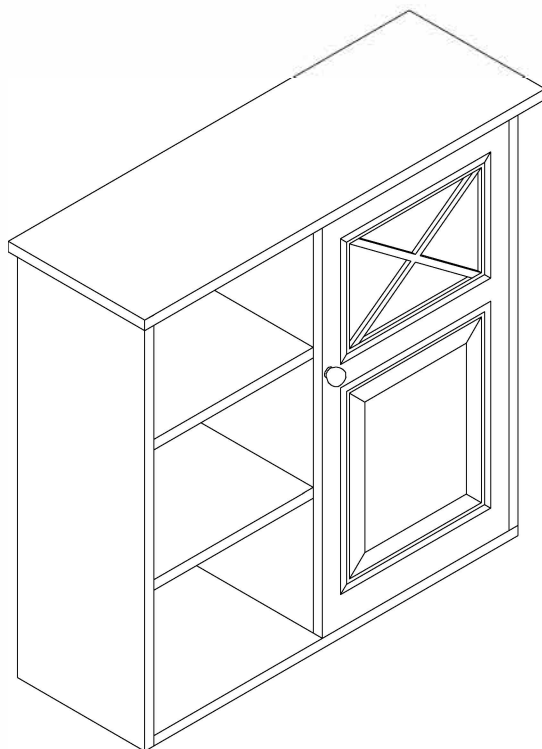

Please provide the following information when contacting for parts or questions: the name of the company you purchased from, the UPS/FedEx tracking number.

ASSEMBLY INSTRUCTIONS-IMPORTANT

Carefully unpack & identify each component before attempting to assemble. Refer to parts list. Please take care when assembling the unit and always set the parts on a clean, soft surface. If you require any assistance with assembly, parts, please call the company you place order with or please email us.

INSTRUCCIONES PARA ARMAR-IMPORANT:







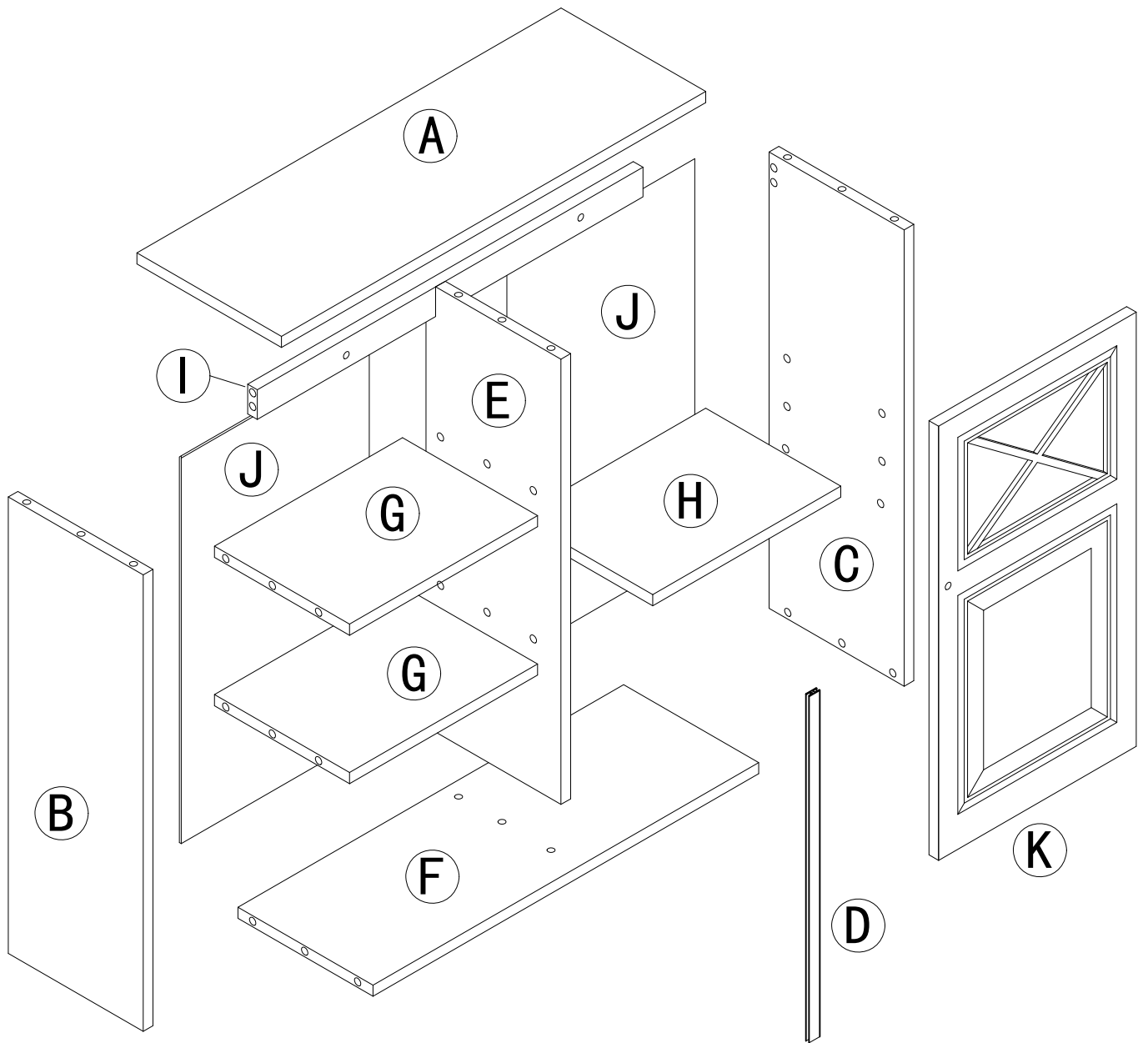

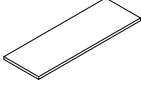

Desempaque e identifique cuidadosamente cada componente antes de intentar ensamblar. Consulte la lista de piezas. Tenga cuidado al ensamblar la unidad y siempre coloque las piezas en una superficie limpia y suave. Si necesita ayuda con el ensamblaje, piezas, llame a la compañía con la que realiza el pedido o envíenos un correo electrónico.

DIRECTIVES DE MONTAGE-IMPORTANT:





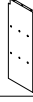



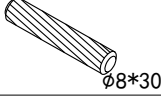

Déballez et identifiez soigneusement chaque composant avant d'essayer de l'assembler. Se référer à la liste des pièces. Veuillez faire attention lors du montage de l'appareil et placez toujours les pièces sur une surface propre et douce. Si vous avez besoin d'aide pour l'assemblage, les pièces, veuillez contacter la société avec laquelle vous passez la commande ou envoyez-nous un e-mail.

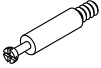

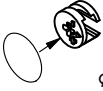
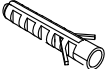
COMPONENTS

PART	FIGURE	DESCRIPTION	QTY	PART	FIGURE	DESCRIPTION	QTY
A		TOP PANEL	1PC	G		FIXED SHELF	2PCS
B		LEFT SIDE PANEL	1PC	H		ADJUSTABLE SHELF	1PC
C		RIGHT SIDE PANEL	1PC	I		UPPER BACK RAIL	1PC
D		PLASTIC BAR	1PC	J		BACK PANEL	2PCS
E		MIDDLE PANEL	1PC	K		DOOR	1PC
F		BOTTOM PANEL	1PC				

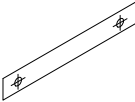
HARDWARE & TOOLS

PART	FIGURE	DESCRIPTION	QTY	PART	FIGURE	DESCRIPTION	QTY
1	 $\phi 8*30$	WOODEN DOWEL	22PCS	8		NOB BOLT	1PC
2		CAM BOLT	14PCS	9		NOB	1PC
3	 $\phi 15*9$	CAM LOCK	14PCS	10		ANCHOR	2PCS
4		SHELF PIN	4PCS	11	 $\phi 4*35$	SCREW	2PCS
5	 $\phi 3*12$	SCREW	4PCS			TEMPLATE PAPER	
6	 $\phi 3*12 D=7$	SCREW	14PCS				

TOOL NEEDED:



**PHILIPS SCREWDRIVER REQUIRED
- NOT INCLUDED**

SUGGESTION:

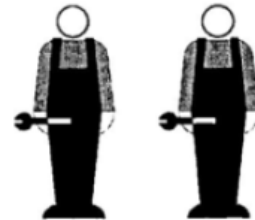

TWO PEOPLE FOR ASSEMBLING



WARNINGS:

1. DO NOT LET ANY SHARP OBJECTS TOUCH OR RUB THE SURFACE OF THE PRODUCT.
2. WHEN ASSEMBLING, DO NOT LET CHILDREN PLAY AROUND THE WORKING AREA.
3. PLEASE CONFIRM ALL PARTS ARE CORRECT BEFORE STARTING THE ASSEMBLY PROCESS.
4. DO NOT TIGHTEN ALL BOLTS AND SCREWS COMPLETELY UNTIL THE ENTIRE UNIT HAS BEEN ASSEMBLED AND SET UP.

1

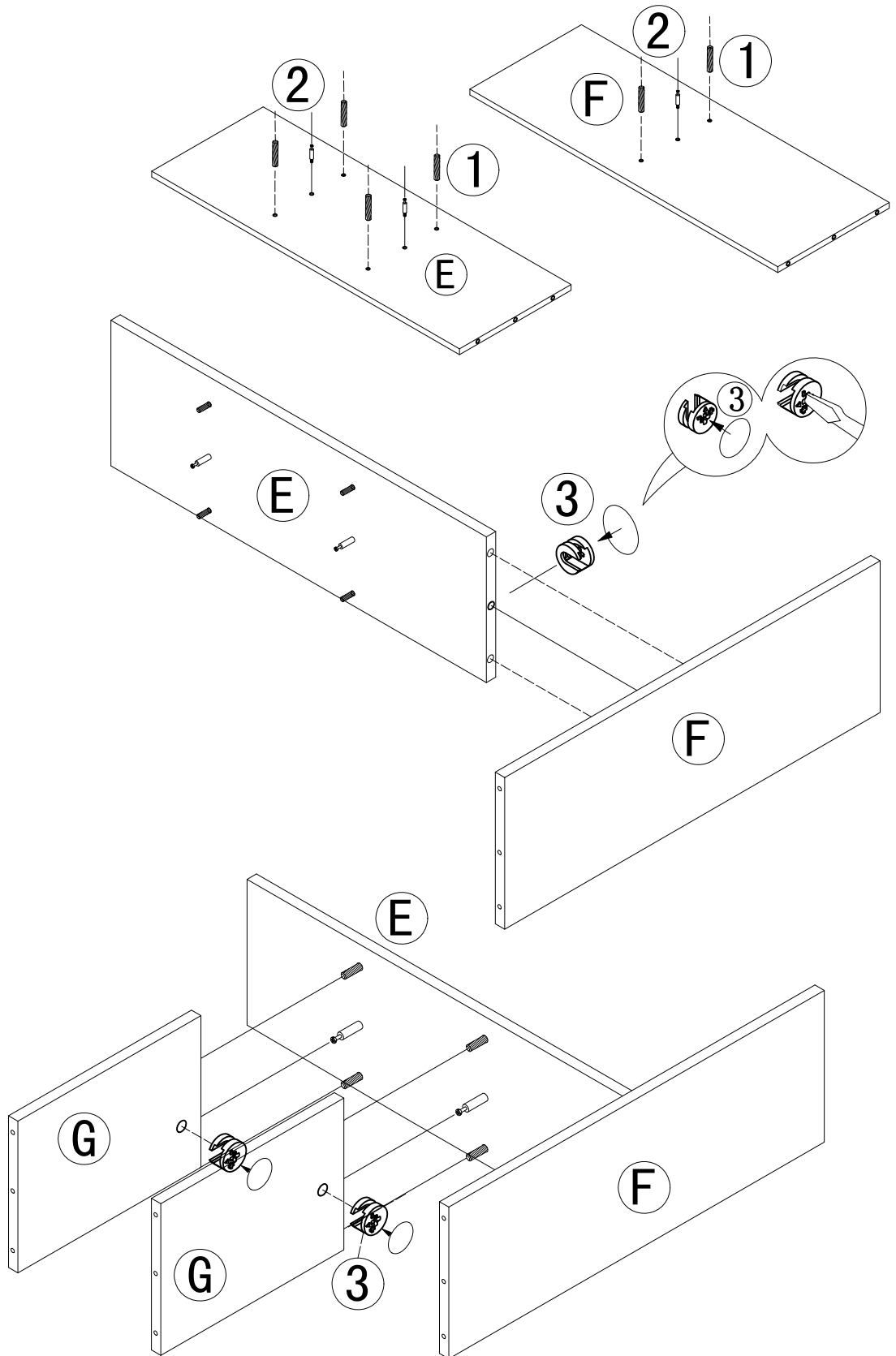
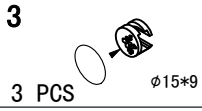
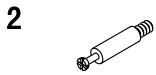

STEP 1:

1. Screw cambolts (2) & insert dowels (1) to panels E & F.
2. Attach panel E to panel F and secure with camlocks (3).
3. Attach shelves G to panel E & secure with camlocks (3).

2

1
10 PCS

2
6 PCS

3
6 PCS $\varnothing 15 \times 9$

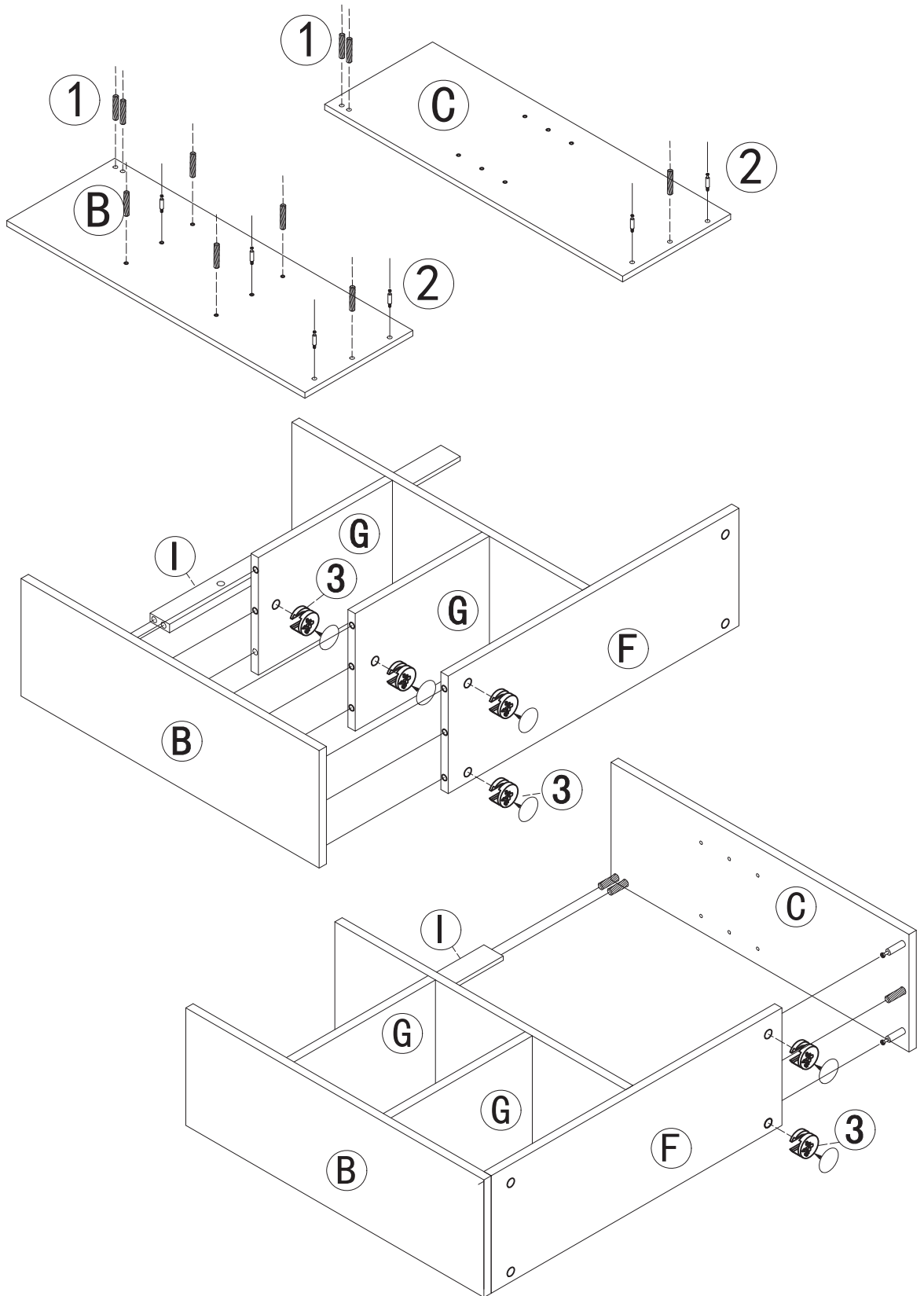

STEP 2:

1. Screw cambolts (2) and insert dowels (1) to panels B & C.
2. Attach rail I, shelves G, & panel F to panel B and secure with camlocks (3).
3. Attach rail I & panel F to panel C and secure with camlocks (3).

3



6 PCS

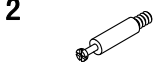

5 PCS



5 PCS

Ø15*9

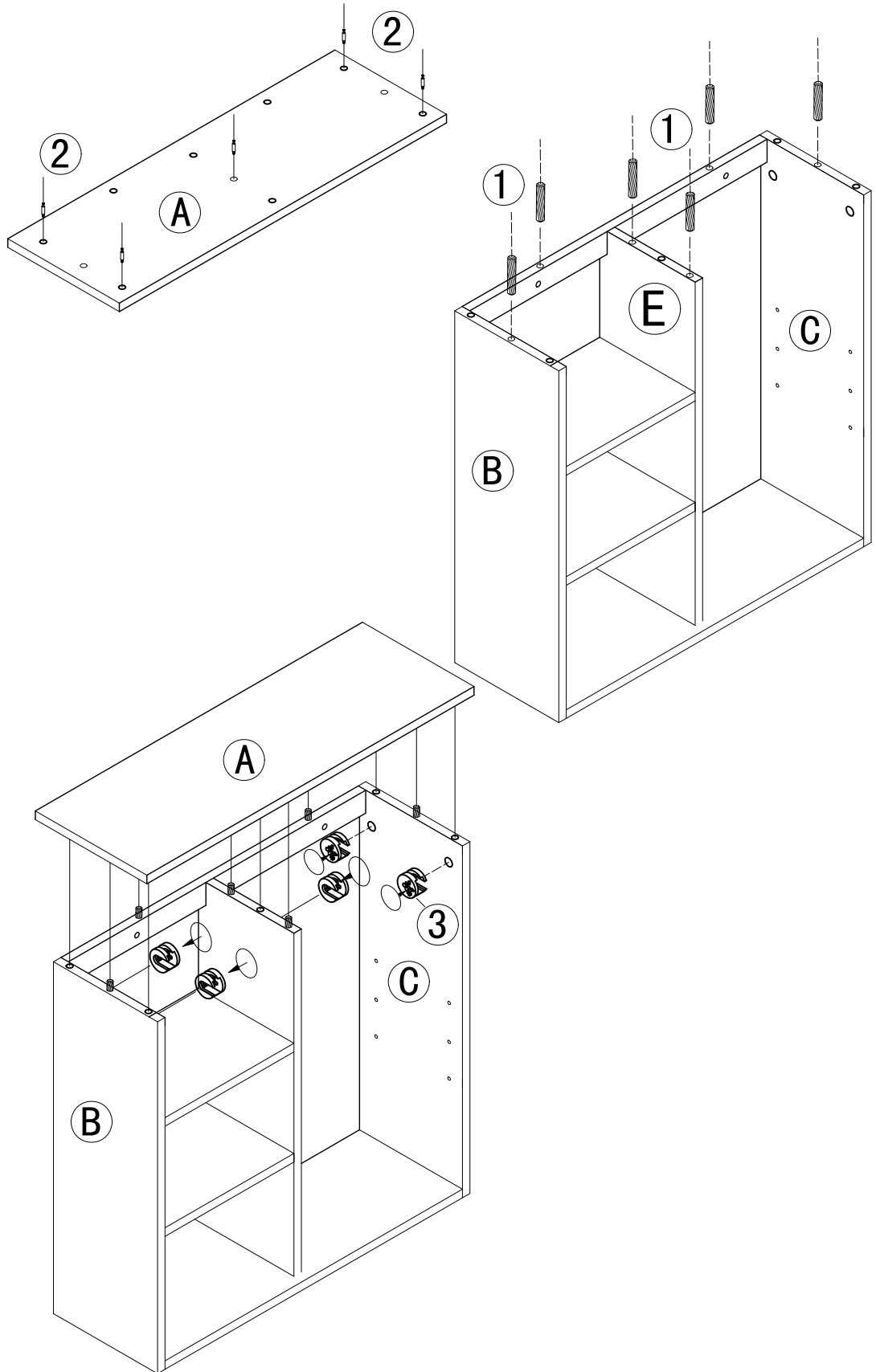

STEP 3:

1. Screw cambolts (2) in panel A.
2. Insert dowels (1) to the top of panels B, C, & E and rail I.
3. Attach panel A to panels B, C, & E and secure with camlocks (3).

4

6



14 PCS $\phi 3 \times 12$ D=7

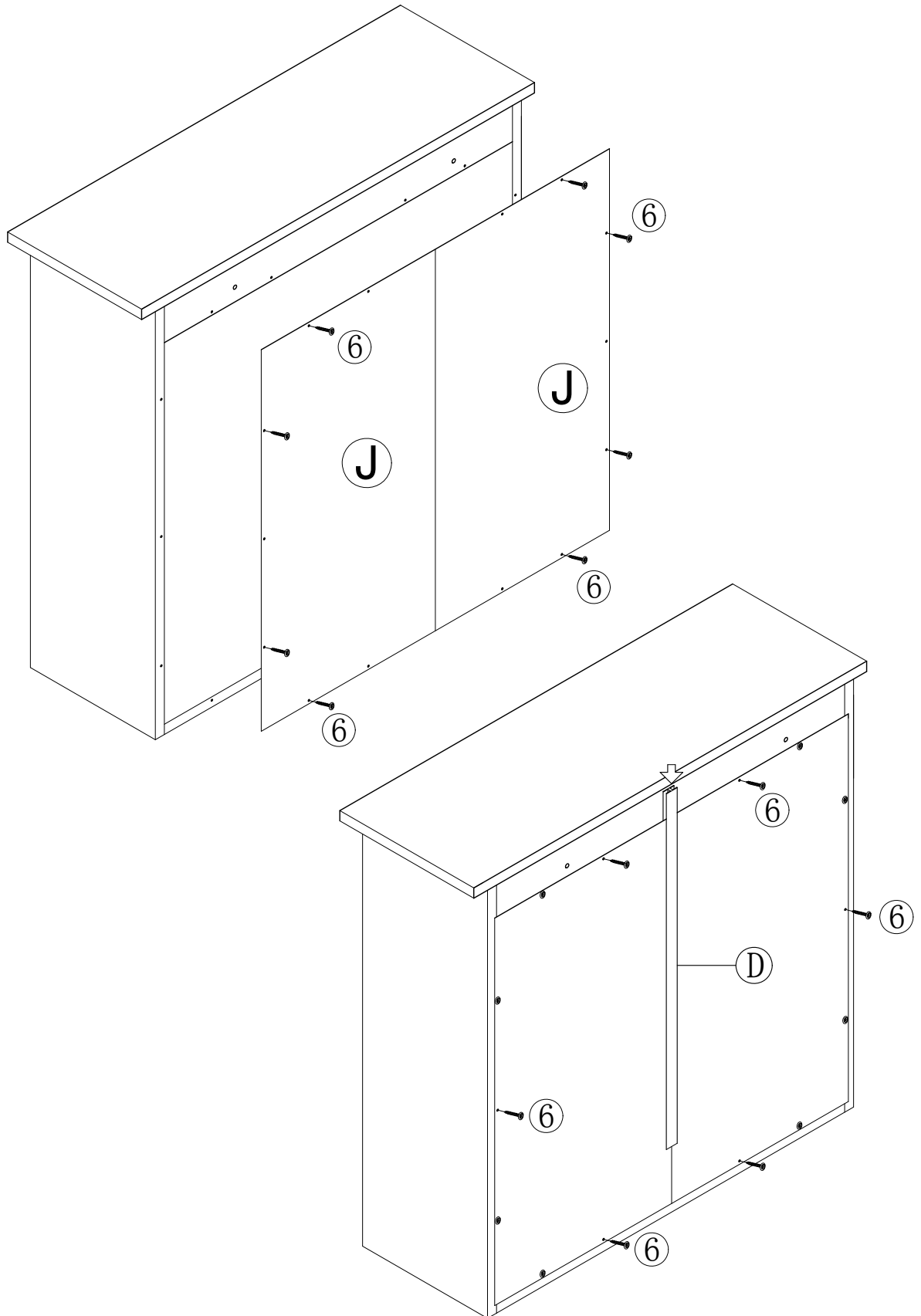

STEP 4:

- 1. Attach back panels J to the cabinet and secure the four corners with screws (6).**
- 2. Insert plastic bar D between back panels J and finish securing the back panels with screws (6).**

5

4

4 PCS



5

4 PCS



∅3*12

8

1 PC



9

1 PC

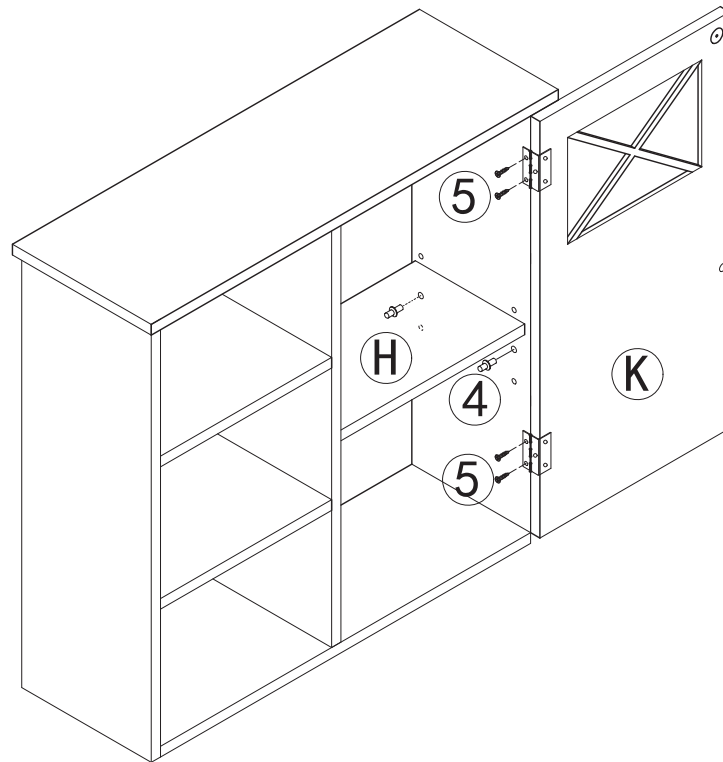
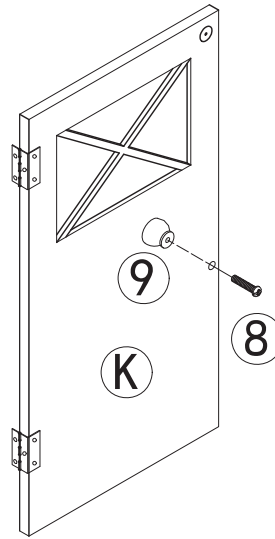

STEP 5:

1. Attach knob (9) to door K with bolt (8).
2. Attach door K to the cabinet with screws (5).
3. Insert shelf pins (4) to panels C & E and rest shelf H on the shelf pins.

6

10



2 PCS

11



2 PCS

φ4*35

