











No	Hardware List	Qty.
1	CSK M4 x 16mm 	16 pcs
2	CSK M4 x 32mm 	8 pcs
3	JCBC M6 x 30mm 	4 pcs
4	JCBC M6 x 45mm 	14 pcs
5	JCBB M8 x 20mm 	8 pcs
6	Flat Washer M6 	10 pcs
7	Spring Washer M6 	10 pcs
8	Allen Key M4 	1 pc
9	Allen Key M5 	1 pc
10	Plastic Washer Leg 	2 pcs
11	Adjuster 	8 pcs

Read this instruction carefully. Remove all wrapping material, staples and straps from the carton. See hardware and furniture part list for guidance. Be sure you have all wooden furniture parts on a clean and flat soft surface, such as a carpet or rug, to prevent from being scratched.

CAUTION :

1. Do not FULLY - TIGHTEN the nut or screw until all is ready to assemble.
2. Do not OVER - TIGHTEN the nut or screw to avoid causing damages to the thread.
3. Keep all hardware part out reach of children.

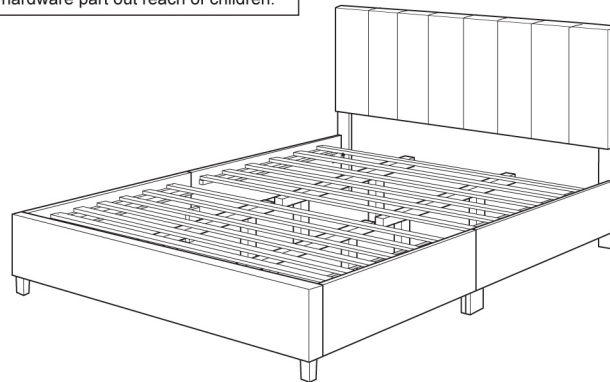

1

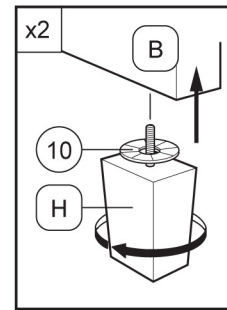
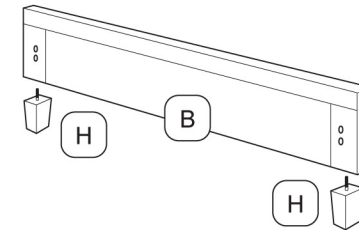

2

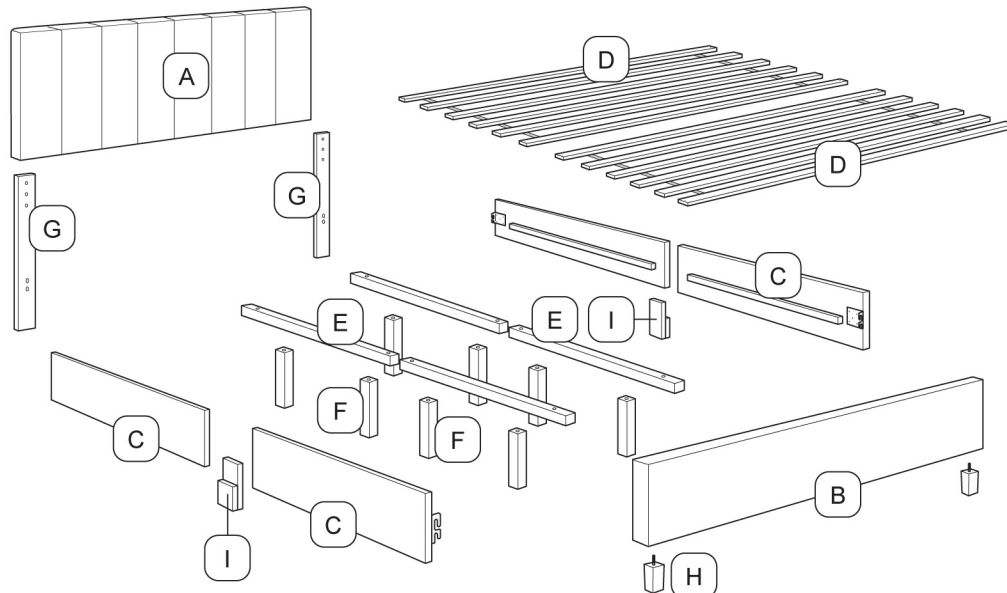
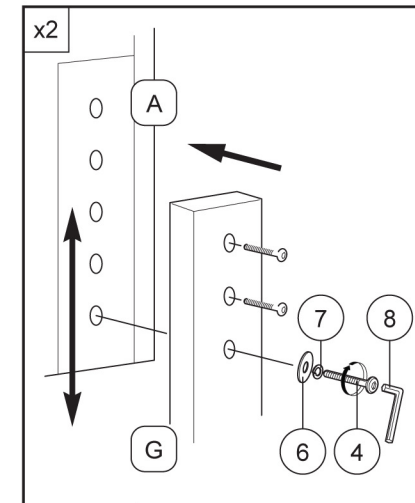
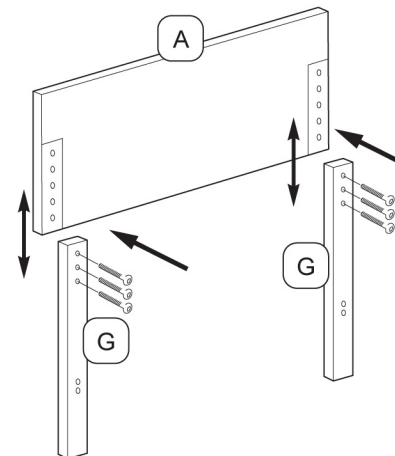

3

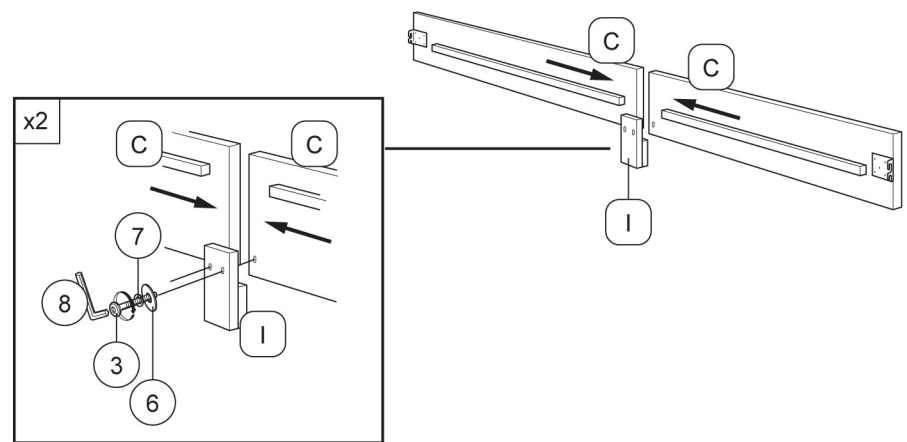

5

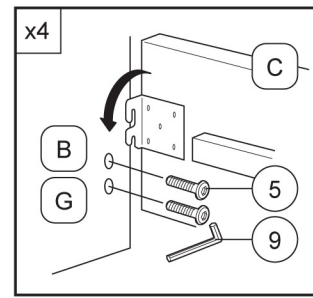
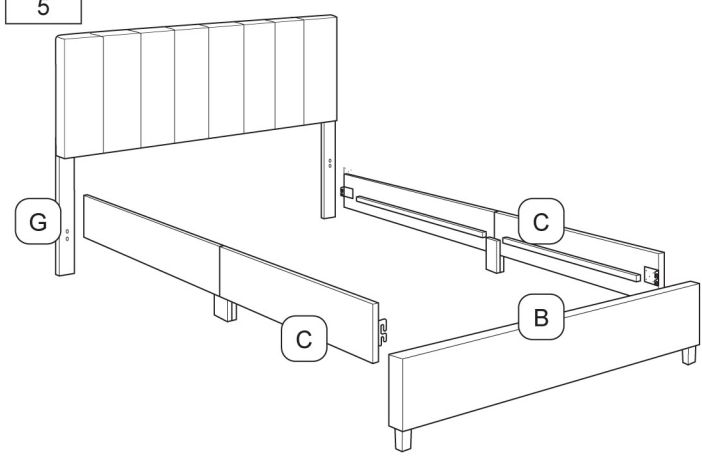

4

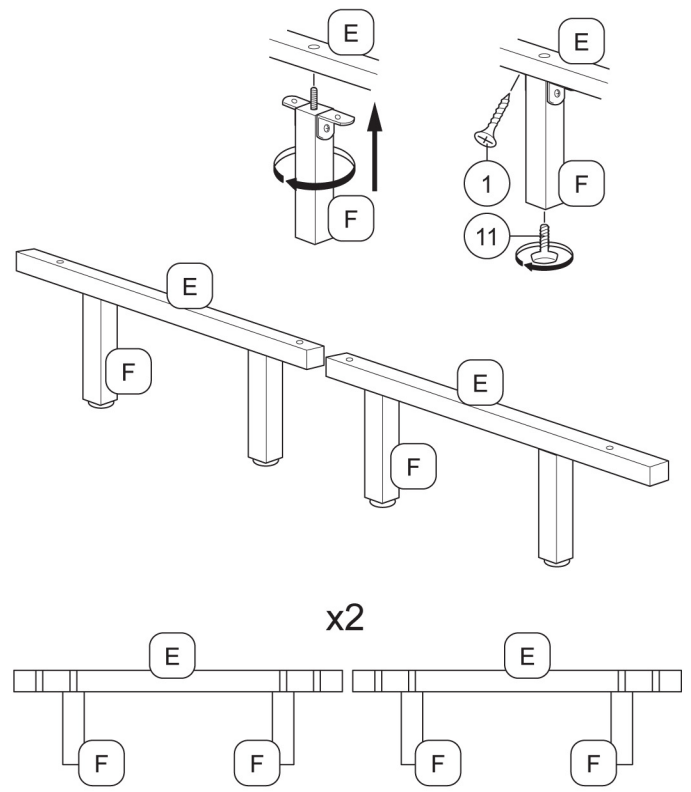

6

