

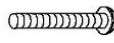



PARTS & ASSEMBLY SHEET

Fixture Name: _____

This fixture assembled PO: _____ Date: _____

Notice: Please review the parts listing and check for all parts before assembling the fixture. If any parts are missing or damaged, please note on this sheet and contact the place of purchase to arrange for replacement parts.

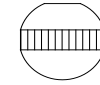
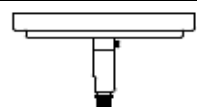
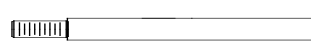
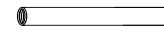
PARTS LIST		Company Name: _____ Co. Account #: _____ below to be filled out by retailer	
Mounting strap 1ea 4" 	Mounting Screw 2ea 8/32"X28mm 	Mounting screw 2ea 8/32X1" 	
Wire connector 3ea P4 Orange 	Hex Nut 2ea 8/32"X3.5mm 	Deco nut (round nut) 2ea @12mm 	
Canopy 1ea 130 Dia*H70mm 	Rod 3ea 12.7mmDia* H12" 	Rod 1ea 12.7mmDia* H6" 	
Part Needed _____	Quantity _____		
Part Needed _____	Quantity _____		
Reason why _____ (missing, scratched, broken glass, bent, bad finish)			
Comments _____			

FIXTURE ASSEMBLY INSTRUCTIONS

Read and review installation instruction sheet before assembling the fixture.

1. By measuring determine correct number of rods needed for proper hanging height.

* This fixture includes 4 rods (6", 12", 12", 12")

2. To shorten the fixture; slide the excess rods off the wires. To lengthen add additional rods.

3. Pull the fixture's wires through the rods (H,I,J,K) until taut and thread the rods together. Then thread to the fixture body (L) and the swivel joint on Canopy (G).

4. Slide the glass shade (M) over Socket of fixture body (L) and secure it by threading the Socket ring (N) on until tight.

5. Install the light bulb in accordance with the fixture's specification.

(DO NOT EXCEED THE MAXIMUM WATTAGE RATING)

NOTE: INSTALL THE GLASS ASSEMBLY AFTER THE FIXTURE IS HUNG.

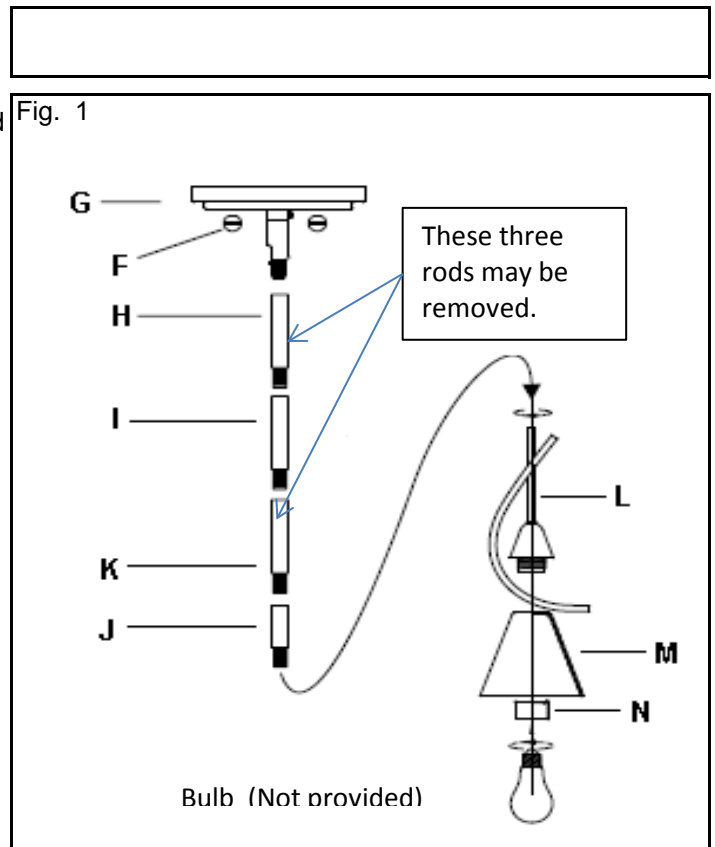

For Customer Service, contact the place of purchase to arrange for replacement parts.

INSTALLATION INSTRUCTIONS

Fixture Name:

For Pendant Light Fixture

WARNING ! SHUT OFF POWER AT FUSE OR CIRCUIT BREAKER.

HANGING THE FIXTURE (Fig. 1)

1. Carefully remove the new fixture from the carton and the yellow bag that holds all your parts. Check that all parts are included as shown in the illustration and parts list.
2. Shut off power at the circuit breaker and remove the old fixture from wall, including the old mounting strap.
3. The Mounting Strap (A) contains several pairs of threaded holes, find the pair of holes that match the holes spacing in your fixture Canopy (G) and thread the two Mounting Screws (B) into the Mounting Strap (A). Secure with Hex nuts (C). These will have their threaded ends protrude through the two holes in the fixture canopy.
4. Place the Mounting Strap (A) over the Junction Box (E) so the Mounting Screws (B) are vertical or horizontal, as required by fixture type.
5. Attach the Mounting Strap (A) to the Junction Box (E) by using the two Mounting screws (D). Tighten the screws securely.

CONNECTING THE WIRES (Fig. 2)

5. Attach the power supply wires to the fixture lead wires by connecting BLACK to BLACK (or SMOOTH) and WHITE to WHITE (or RIBBED).
6. Attach the GROUND wire (GREEN or COPPER) from the Junction Box and the fixture Ground wire to the green Ground Screw on the Mounting Bracket (A) or connect both wires together using the correct size of wire connectors.
NOTE: Twist the wires together in the same direction you twist the wire connector onto the wires.
7. Tuck these wire connections neatly into the Junction Box.

FINISHING THE INSTALLATION (Fig. 3)

9. Place the fixture Canopy (G), over the Mounting screws (B), so they protrude through the holes in the Canopy (G).
 10. Thread the Deco Nuts (F) onto the Mounting Screws (B) and continue turning until the Canopy (G) is snug against the ceiling.
 11. Install glass shades as per the fixture assembly instructions.
- YOUR INSTALLATION IS NOW COMPLETE.
RETURN POWER TO THE JUNCTION BOX AND TEST THE FIXTURE.**

Fig. 1

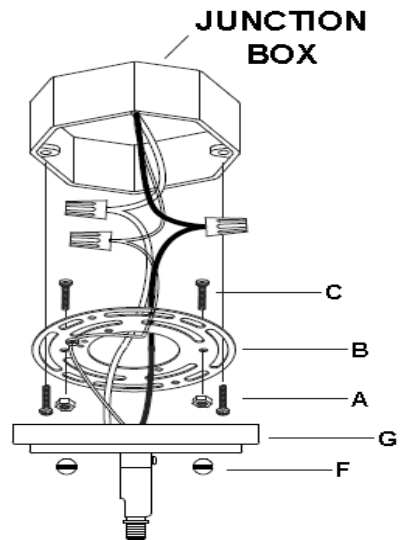

Fig. 2

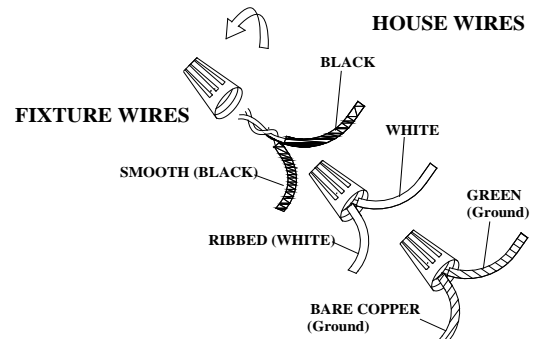

Fig. 3

