

ASSEMBLY INSTRUCTIONS

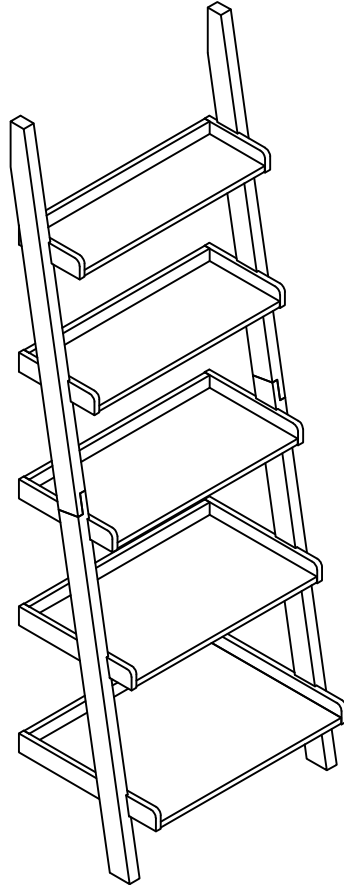

800338
Ladder **ITEM: 800338**

ITEM:800338

ASSEMBLY INSTRUCTIONS

ASSEMBLY TIPS:

- 1.Remove hardware from box and sort by size.
- 2.Please check to see that all hardware and parts are present prior to start of assembly.
- 3.Please follow attached instructions in the same sequence as numbered to assure fast & easy assembly.

Warning !!

1. Don't attempt to repair or modify parts that are broken or defective. Please contact the store immediately.
2. This product is for home use only and not intended for commercial establishment.



ASSEMBLY TIME

30 MINUTES

PARTS IDENTIFICATION

(A) RIGHT LEG-UPPER	1 PC	(G) UPPER RIGHT SIDE PANEL	1 PC
(B) LEFT LEG-UPPER	1 PC	(H) MID-UPPER LEFT SIDE PANEL	1 PC
(C) RIGHT LEG-LOWER	1 PC	(I) MID-UPPER RIGHT SIDE PANEL	1 PC
(D) LEFT LEG-LOWER	1 PC	(J) MID LEFT SIDE PANEL	1 PC
(E) BACK BAFFLE	5 PCS	(K) MID RIGHT SIDE PANEL	1 PC
(F) UPPER LEFT SIDE PANEL	1 PC	(L) MID-LOWER LEFT SIDE PANEL	1 PC

ITEM:800338

PARTS IDENTIFICATION

(M) MID-LOWER RIGHT SIDE PANEL 1 PC

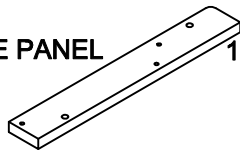

(N) LOWER LEFT SIDE PANEL 1 PC

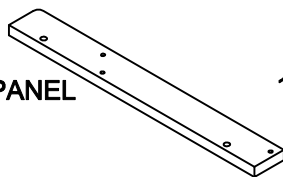

(O) LOWER RIGHT SIDE PANEL 1 PC

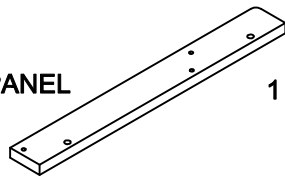

(P) UPPER SHELF 1 PC

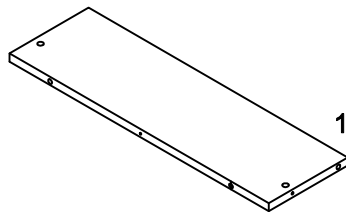

(Q) MID-UPPER SHELF 1 PC

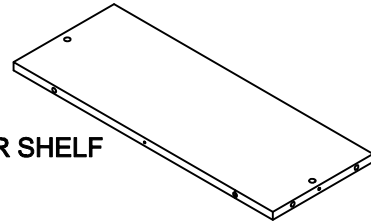

(R) MID SHELF 1 PC

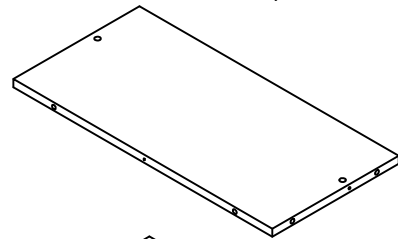

(S) MID-LOWER SHELF 1 PC

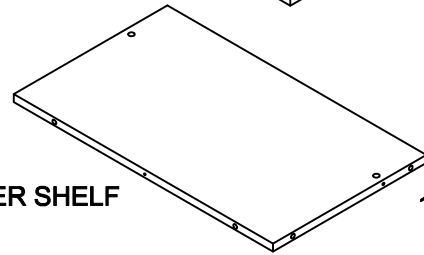



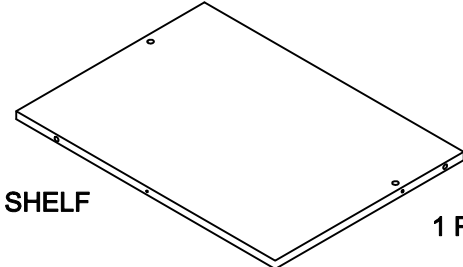





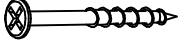



(T) LOWER SHELF 1 PC

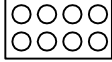
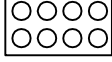
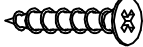

ITEM:800338

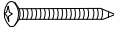
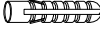
HARDWARE IDENTIFICATION

1	SELF-TAPPING SCREW	ø4x35mm		15pcs
2	CHAMFER SELF-TAPPING SCREW	ø4.2×65mm		10pcs
3	SMALL FLAT SCREW	ø6×12mm		8pcs
4	LARGE FLAT SCREW	ø6×20mm		4pcs
5	CAP SCREW	M6×11mm		4pcs
6	CONNECTION PLATE	170×24×3mm		2pcs
7	WOODEN DOWEL	ø8×25mm		28pcs
8	LARGE STICKER	ø22mm		8pcs
9	SMALL STICKER	ø13mm		30pcs
10	SELF-TAPPING SCREW	ø4x30mm		10pcs
11	THE RESTRAINT STRAP	197×5×1mm		1pc
12	BRACKET	12×12×1mm		2pcs
13	SMALL SCREW	ø4x25mm		1pc
14	WALL SCREW	ø5x40mm		1pc
15	PLASTIC ANCHOR	ø8x40mm		1pc
16	GLUE			1pc

ITEM: 800338

ASSEMBLY INSTRUCTIONS

STEP 1

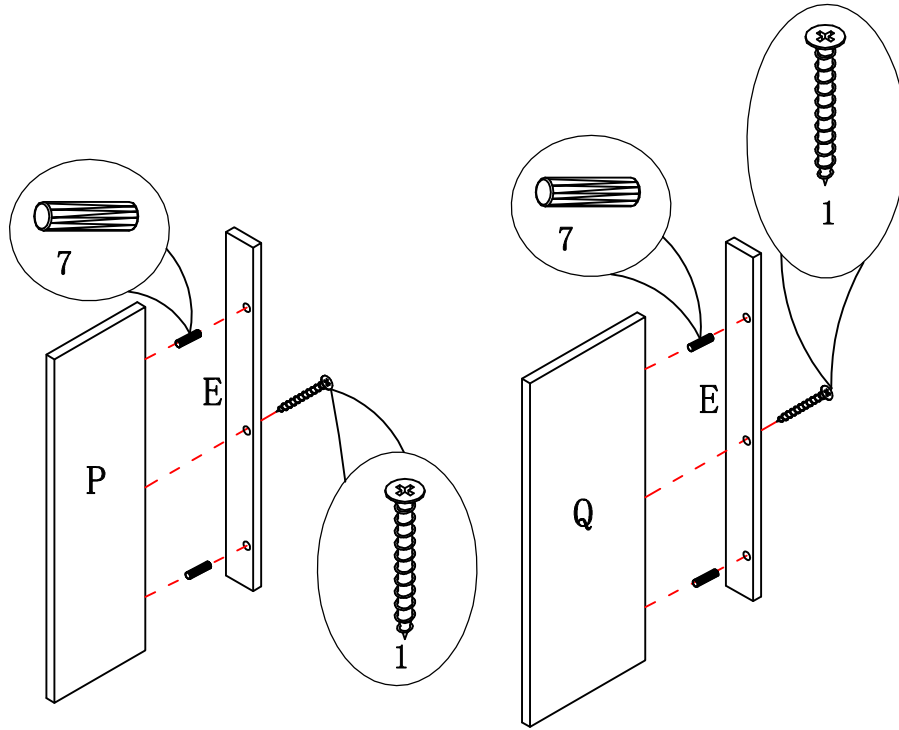

STEP 2

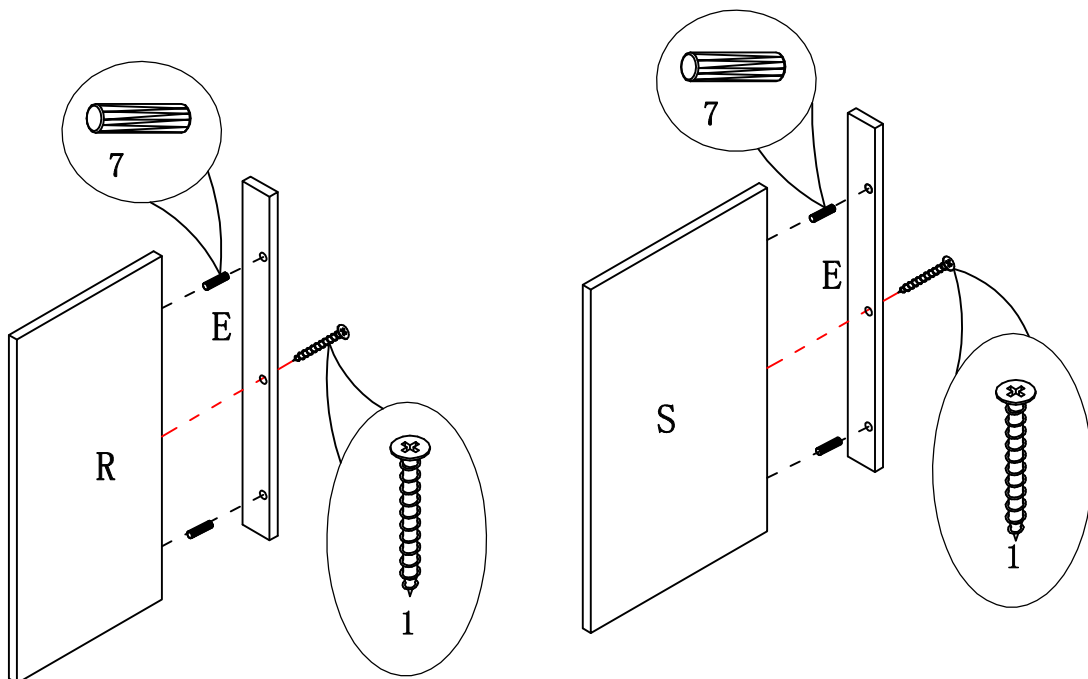

ITEM: 800338

ASSEMBLY INSTRUCTIONS

STEP 3

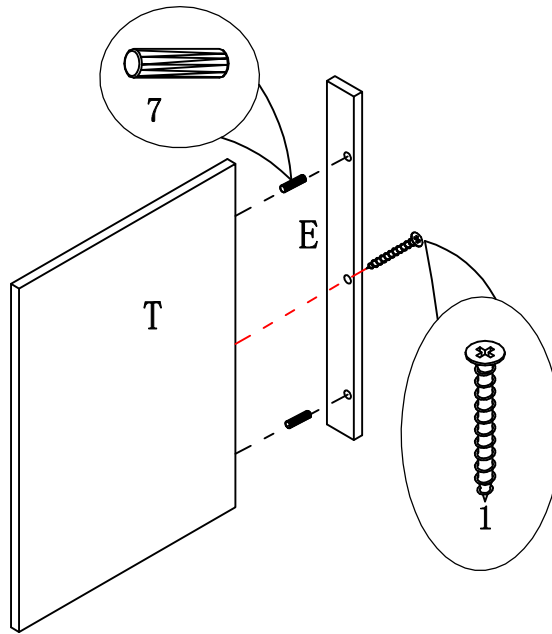

STEP 4

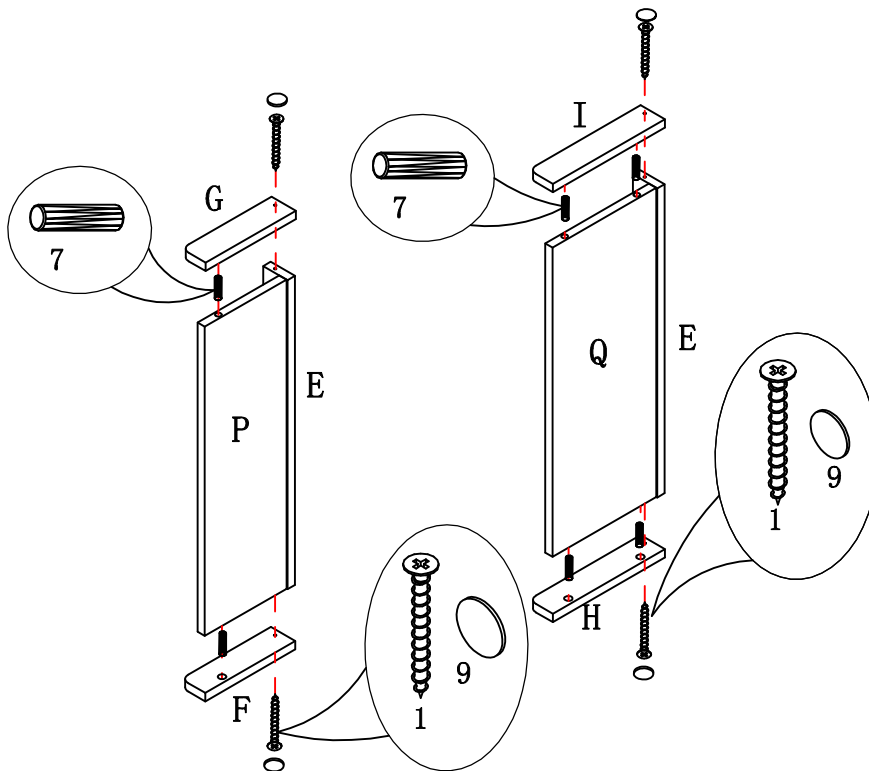

ITEM: 800338

ASSEMBLY INSTRUCTIONS

STEP 5

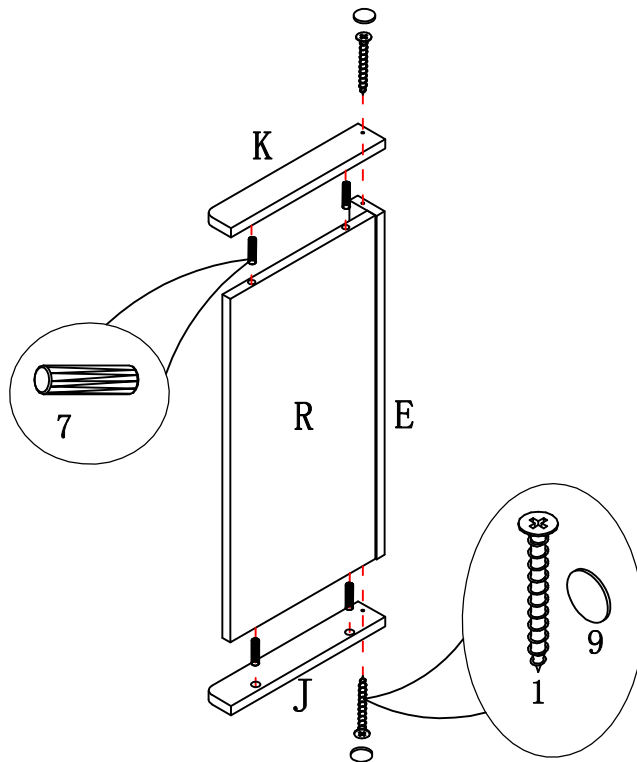

STEP 6

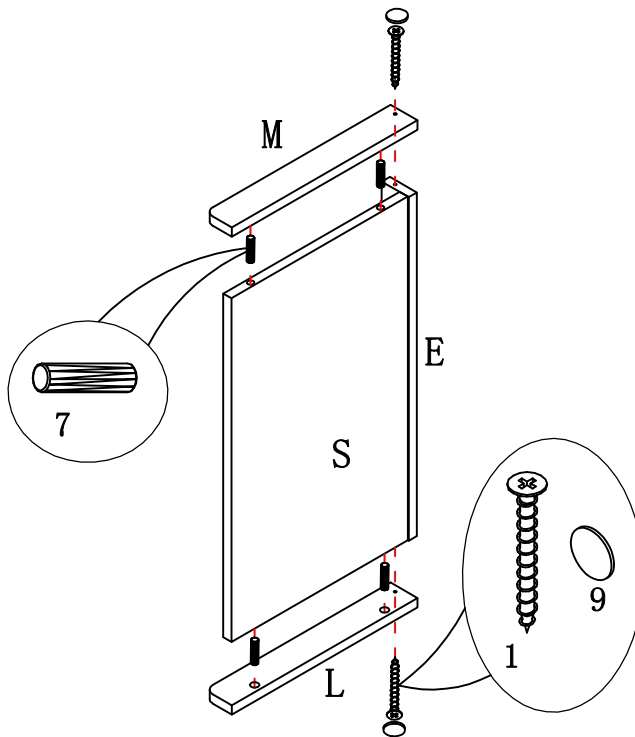

ITEM: 800338

ASSEMBLY INSTRUCTIONS

STEP 7

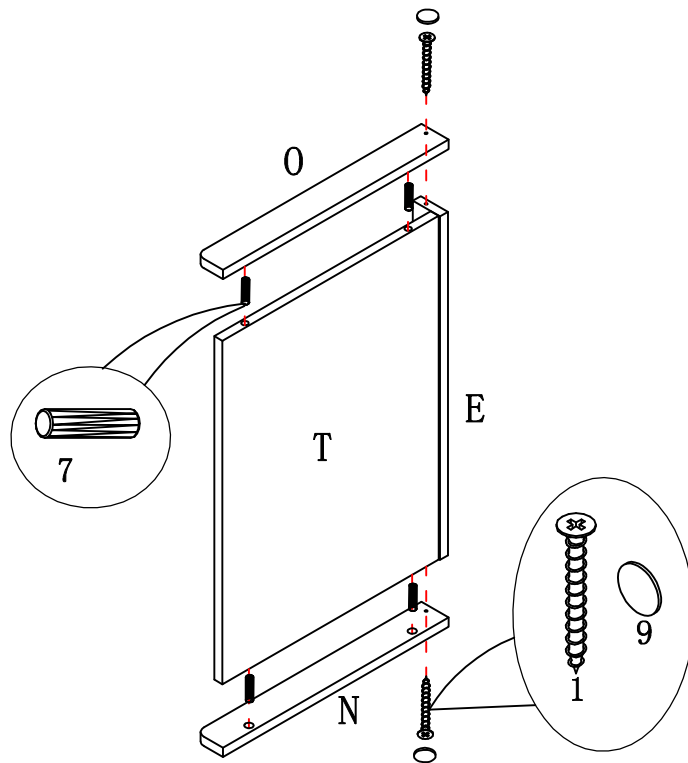

STEP 8

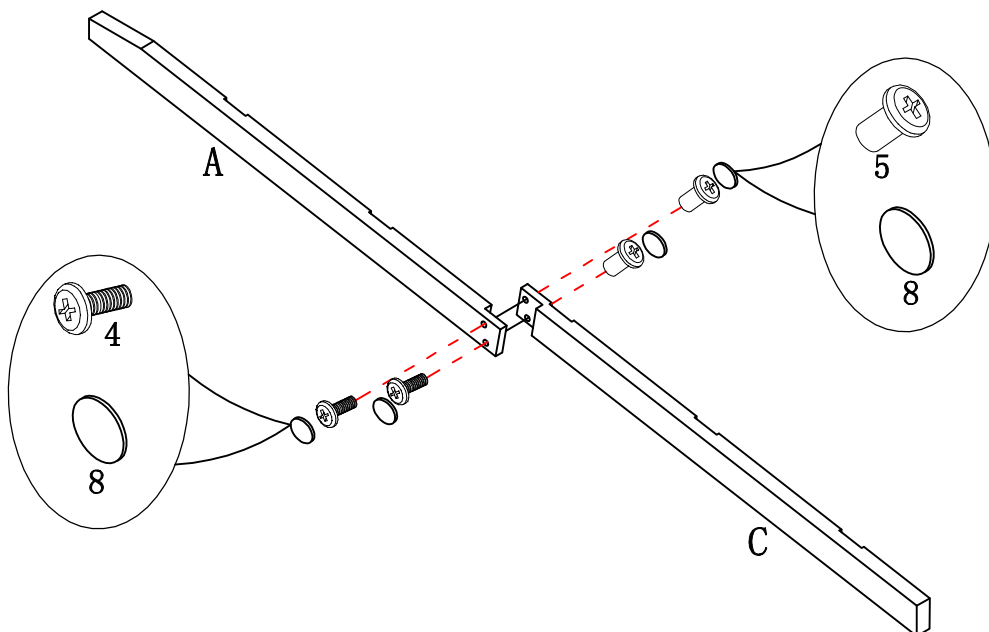

ITEM: 800338

ASSEMBLY INSTRUCTIONS

STEP 9

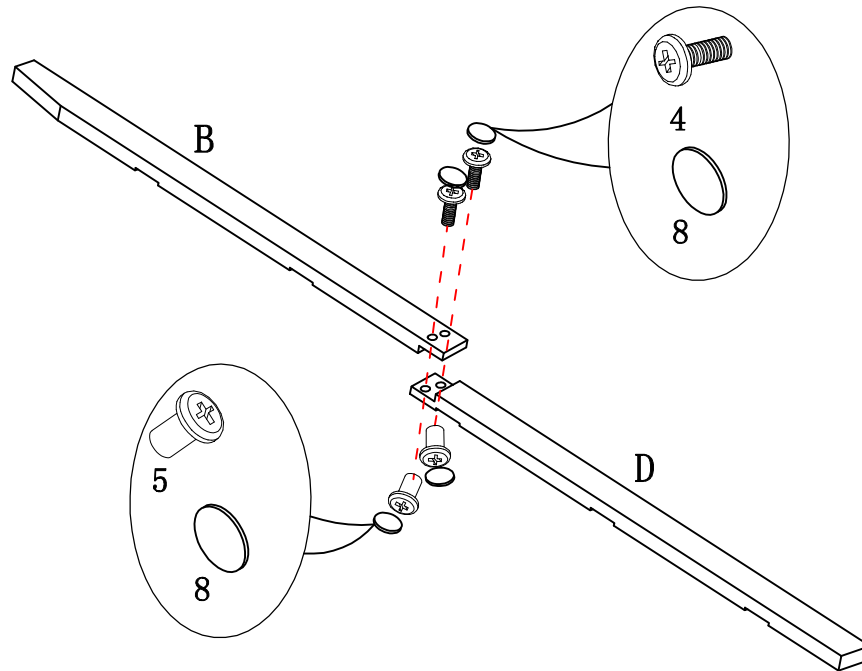

STEP 10

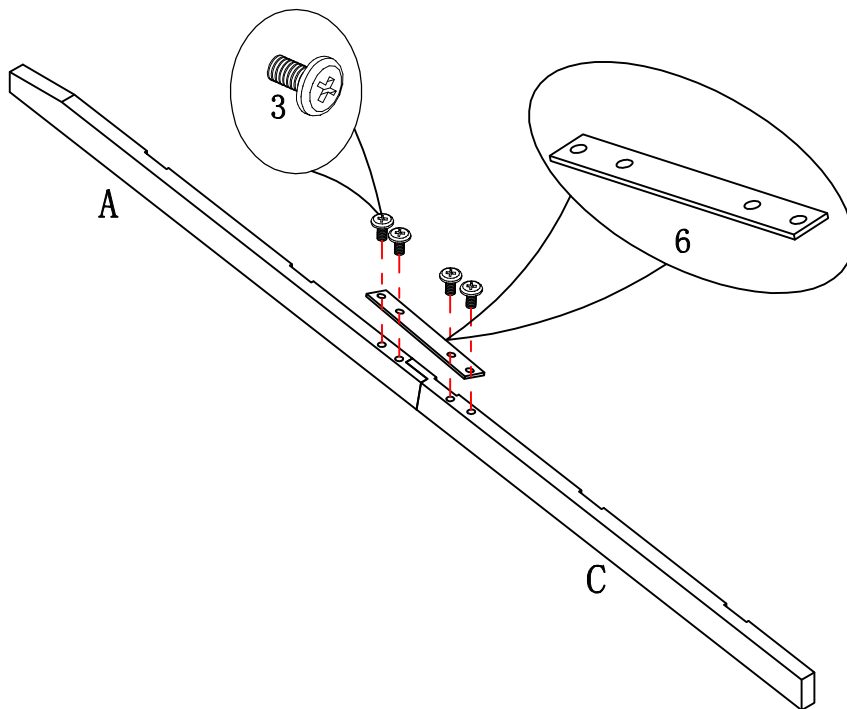

ITEM: 800338

ASSEMBLY INSTRUCTIONS

STEP 11

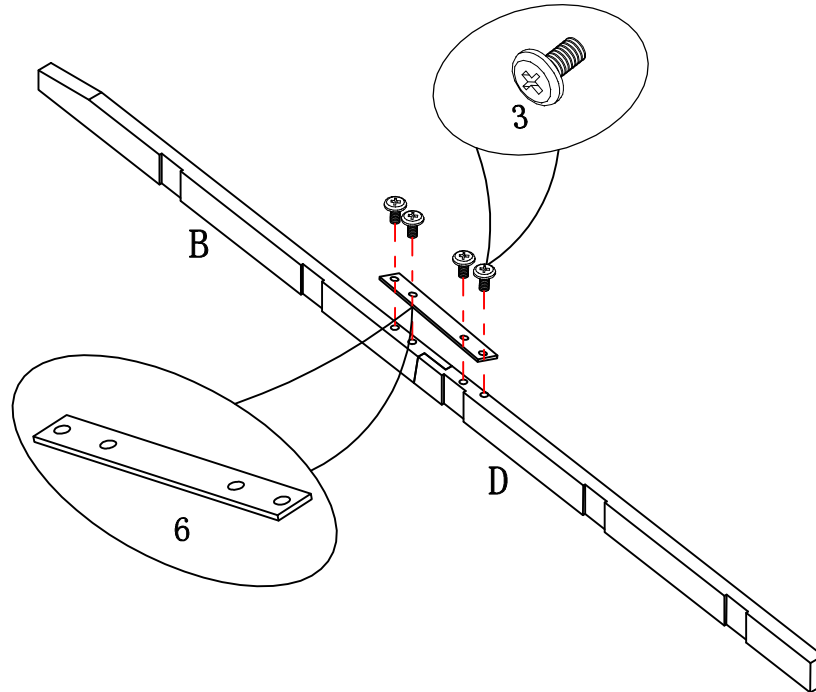

STEP 12

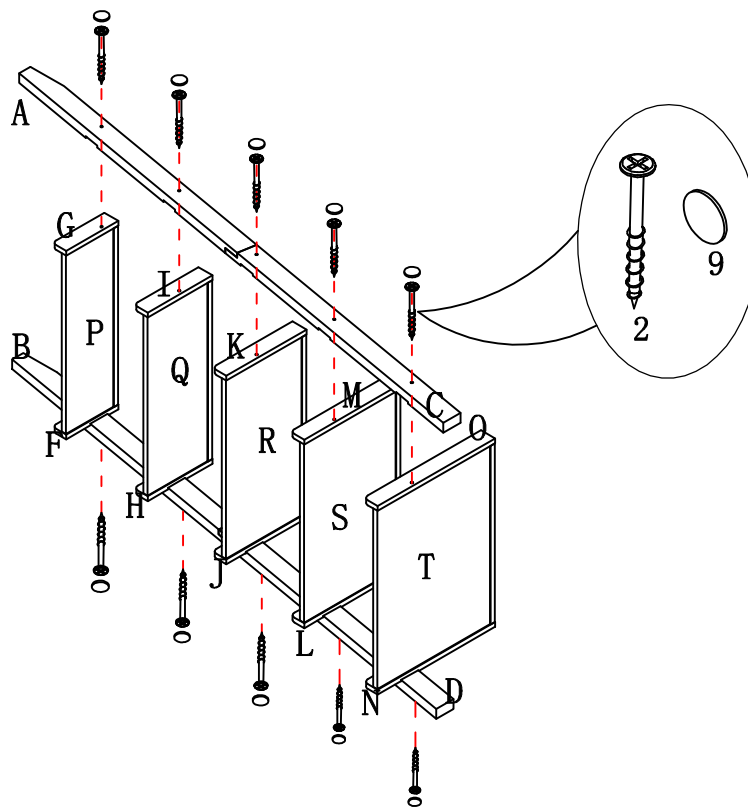

ITEM: 800338

ASSEMBLY INSTRUCTIONS

STEP 13

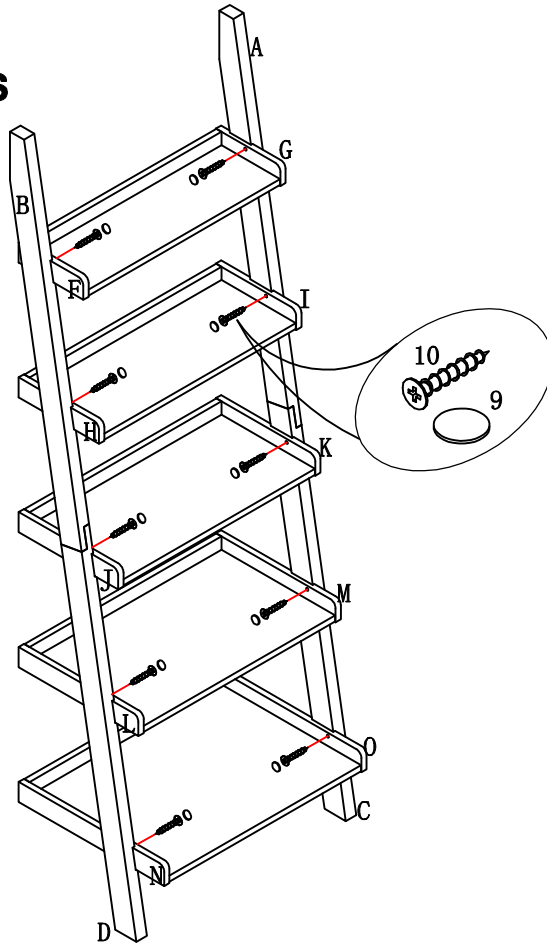

STEP 14

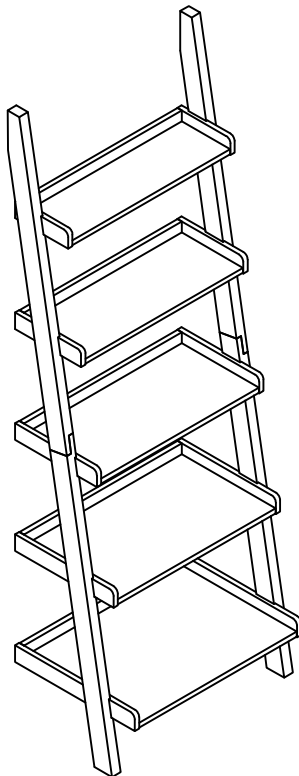

ITEM: **800338**

ANTI-TIPPING INSTALLMENT INSTRUCTIONS

FURNITURE TIPPING RESTRAINT

WARNING

Injury may result from tipping furniture.
This restraint may protect against tipping furniture.
Do not allow children to climb on furniture.
This restraint is not a substitute for proper adult supervision.
Failure to detach this restraint before moving the furniture may result in injury and damage.

This tip restraint must be attached to a wall stud using long screw enclosed.

STEP 1

Attach a bracket securely to the back top rail to the furniture using short screw provided, through the smaller hole.

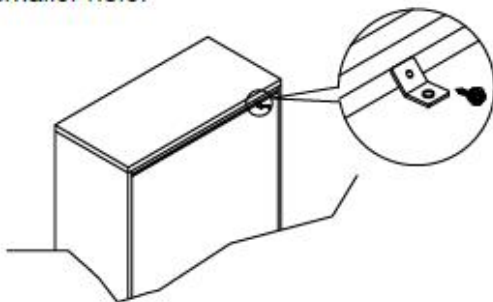

STEP 2

Locate the other bracket on the wall over a wall stud and two inches below the mounting bracket secured to the back of the furniture. Attach the wall stud using the long screw provided, through the smaller hole.

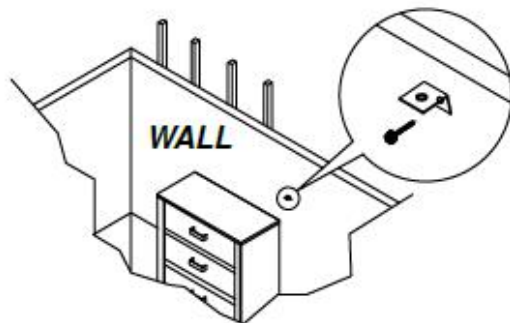

STEP 3

Place the furniture into position so both mounting brackets are vertically in line. Lace the end of the restraint strap through the larger hole in each mounting bracket. Bring both ends together and slide the flat end through the locking and draw it until all slack is removed. Confirm that the strap is securely laced and locked.

