

ASSEMBLY INSTRUCTION

75 -136 POSTER BED

IMPORTANT NOTES :

- . Place all wooden parts on a clean and smooth surface such as a rug or carpet to prevent the parts from being scratched.
- . Check to be sure that you have all parts and hardware.
- . Remove all wrapping materials, including staples and packing straps before you start to assemble.
- . Do not tighten all screws and bolts until completely assembled.
- . Keep all hardware out of the reach of children.

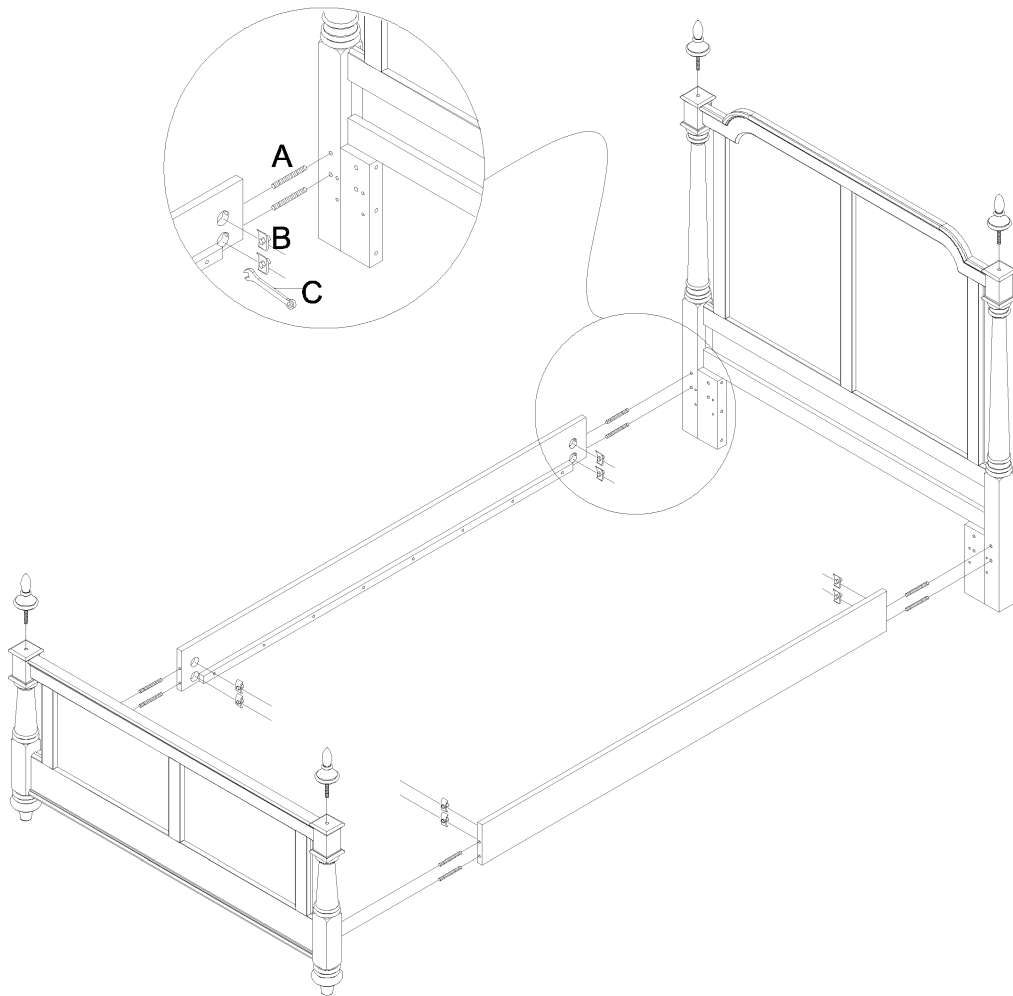

CODE	DESCRIPTION	QTY
A	 THREAD ROD 5/16*3-7/16"	8
B	 CURVED SLOTTED WASHER 5/16"	8
C	 WRENCH	1

MADE IN VIETNAM