

Assembly Instructions

Caution : You must read this before you proceed



Table

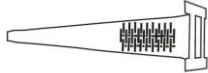

Parts List

Label	Picture	Description	QTY
A		Woven Table Top	1
B		Table Leg	4

Hardware

Label	Picture	Description	QTY
①		Allen Key	1
②		Screw with Flat Washer Ring	17

Assembly Preparation

Before Beginning Assembly:

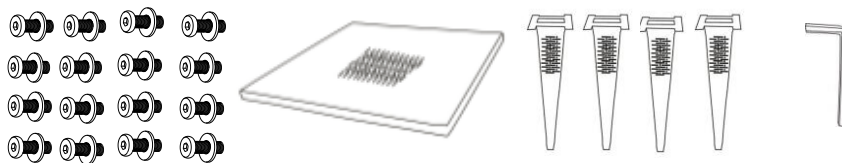

- Read instructions, cover to cover-



- Have 2 adults on hand for assembly-



- Do not assemble on flooring or carpet-



- Assemble on a clean non-marring surface (packing foam)-



- Save all packaging until finished-

Assembly Steps

Overview

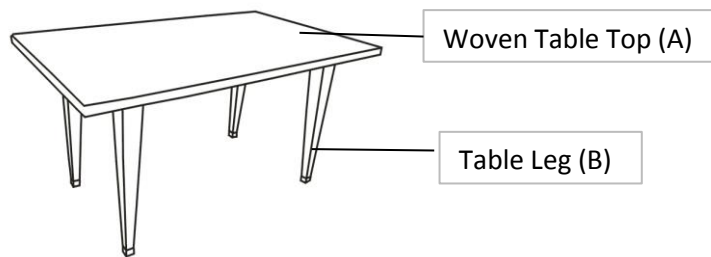

This Table has multiple parts and may require up to some 30 minutes to assemble. To give you an overview of the Table parts, the above picture is to help you put the various parts into perspective. Please read through the instructions below to familiarise yourself with the parts and steps before assembly.

Step 1

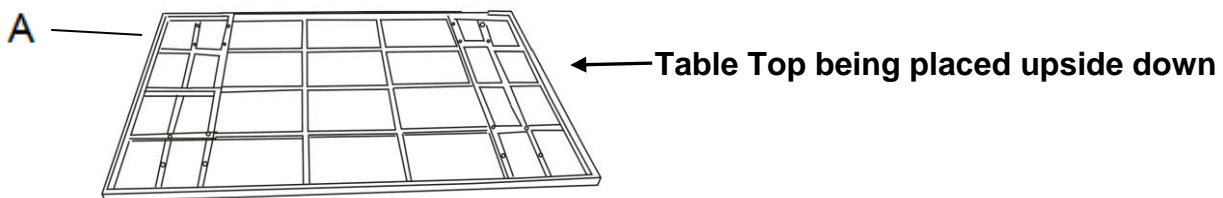

Place the Woven Table Top(A) with top facing downwards on a sofa, clean surface.

Step 2

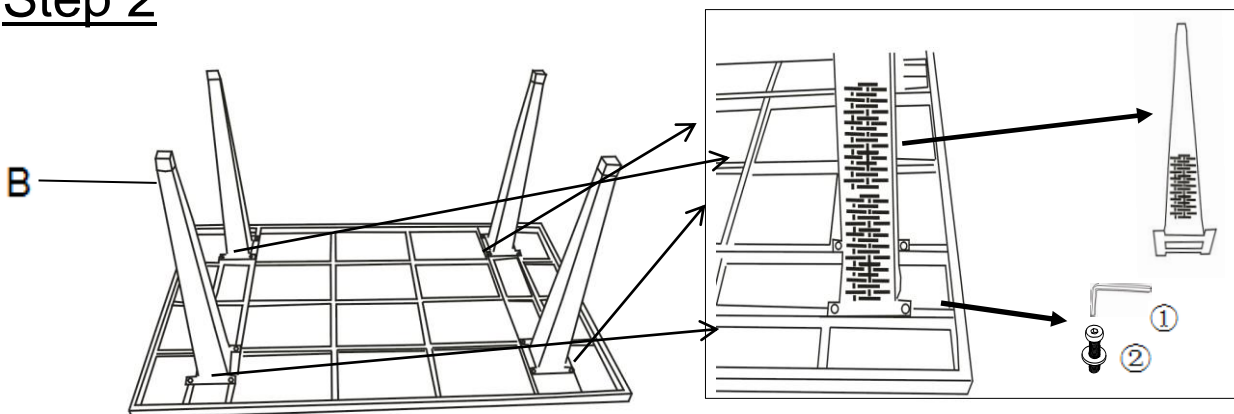

Then, place the table leg(B) over screw points.

Attach the screw with Flat Washer Ring(②) onto the contact point as shown in picture.

Tighten screw with the Allen Key(①).









Repeat the same assembly process for the remaining three legs and respective screw points.

Step 3



Turn the table RIGHT Side Up. Your Table is ready for use.

Care & Maintenance

- ⊘  ● Do not put hot items directly on furniture surface
- ⊘  ● Do not clean furniture with harsh cleansers or polish.
- ✓  ● To obtain the longest lifespan of your outdoor products, minimizing exposure to direct sunlight is recommended.
- ⊘  ● Children should not climb or jump on the furniture.
- ⊘  ● Do not write on furniture without a padded barrier to protect the surface.
- ✓  ● To obtain the longest lifespan of your outdoor products, avoid extended and lengthy exposure to rain, snow, and direct sunshine. Whenever possible cover the product and /or place under patio or awnings.
- ⊘  ● Not for commercial use. For residential use only .
- ⊘  ● Stains may be removed with mild soap solution and damp cloth.
- ⊘  ● Keep away from sources of ignition.

-
- ✓  ● Dust and pick-up spills using a clean, non-colored, lint-free cloth .
-