





ASSEMBLY INSTRUCTIONS

EASTERN KING (4+8)

(Box 1)

BOX OF HEADBOARD & FOOTBOARD

No	ITEM	Qty
A	Headboard 	1 pc
B	Footboard 	1 pc
C	Headboard Leg 	2 pcs
D	Bed Slats 	4 pcs
E	Bed Slats Support 	8 pcs





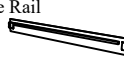

(Box 2)

BOX OF SIDE RAIL

No	ITEM	Qty
F	Side Rail 	2 pcs

(Box 1)

HARDWARE LIST

No	ITEM	Qty
1	JCBC M6 x 40mm 	4 pcs
2	SPRING WASHER 1/4" Blk 	4 pcs
3	Flat Washer 1/4"ID x 13mmOD Blk 	4 pcs
4	ALLEN KEY m4x65mm Blk 	1 pc
5	ALLEN KEY m5x65mm Blk 	1 pc
6	Flat Head Chipboard Screw m4x32mm Rbw 	16 pcs

STEP 1.1 : Attach Head Board Leg (C) to Head Board (A) as shown using JCBC BOLT (1)with Spring Washer (2), Flat washer (3)and securing with ALLEN KEY (4).

STEP 1.2 : Fix the other holes with Csk Screw (6) as shown.

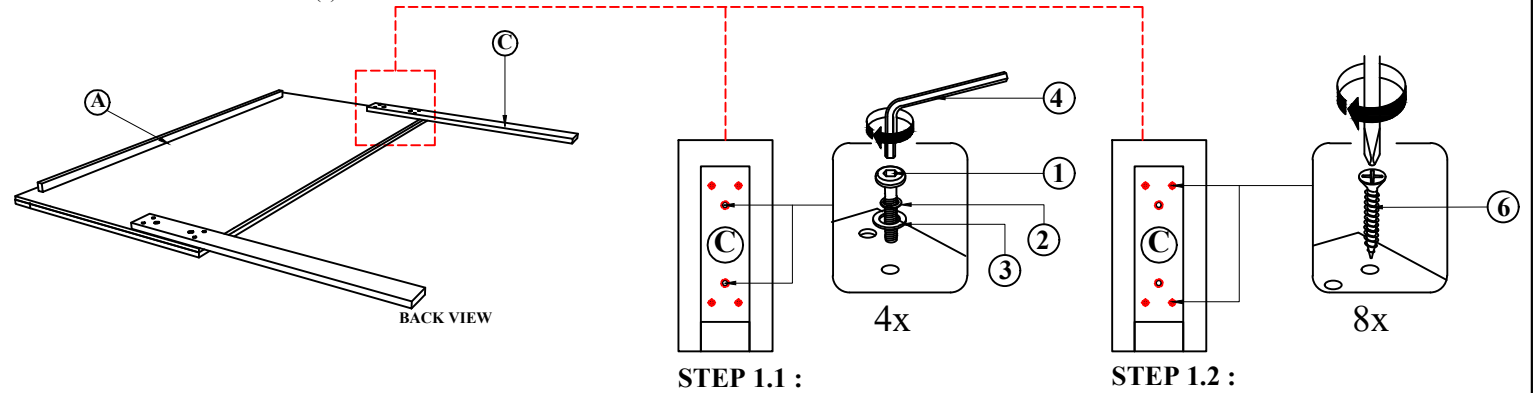

STEP 2 : Hook SIDE RAIL(F) TO HEAD BOARD (A) closely and push down to fit. repeat step 2 with other end of rail to hook onto FOOTBOARD (B).

STEP 2.2 :

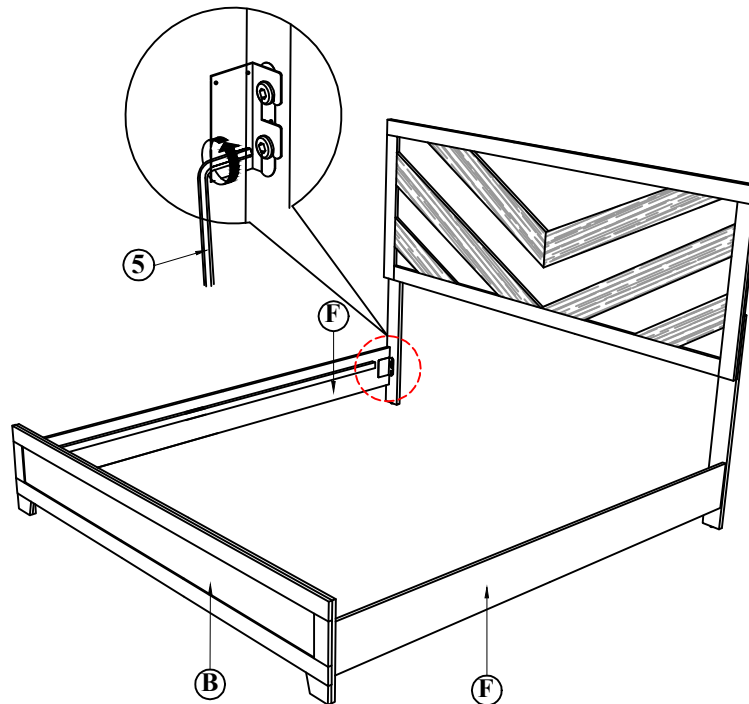

STEP 3 : Tighten the 4 Corner with Allen Key (5). Fix the Bed Slat Support Leg (E), to Bed Slat (D) as shown . Install the bed slat (D) to side rail (F) and tighten with Csk Screw (6) as per diagram shown. (NOTE: THE SETUP MUST DONE AT THE DECIDED LOCATION FOR THE BED TO OBTAIN PERFECT STABILITY)

STEP 3.2 :

STEP 3.1 :

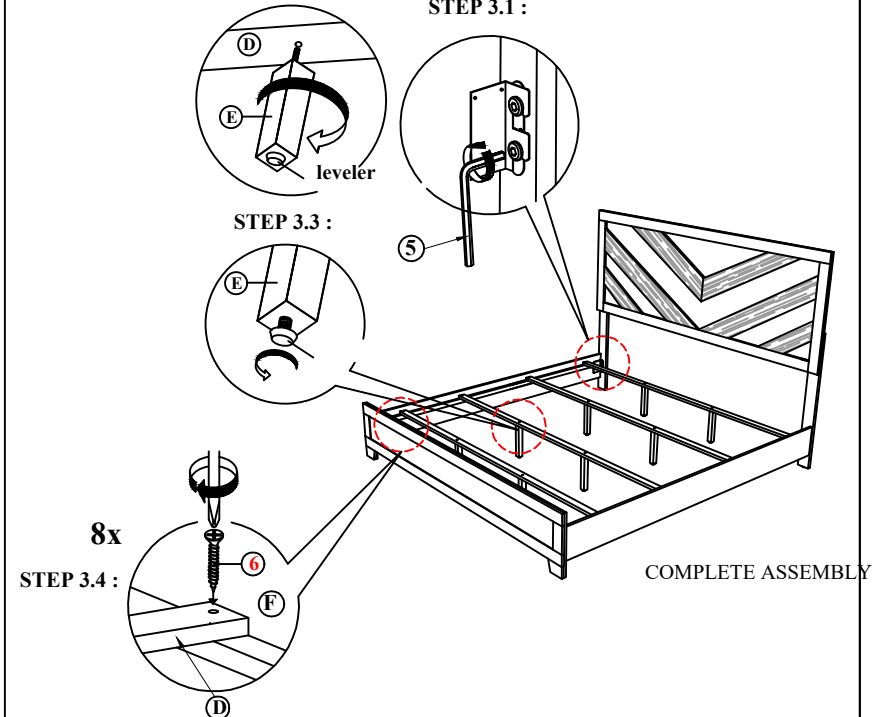

NOTE : MUST TIGHTEN SCREWS PERIODCALLY WITH USE SCREW WILL BECOME LOOSE CHECK TIGHTNESS OF ALL SCREW EVERY 6-8 WEEKS.

PAGE 1 OF 1