

ASSEMBLY INSTRUCTIONS

HYDS-014-HT

HYDS-014-HS

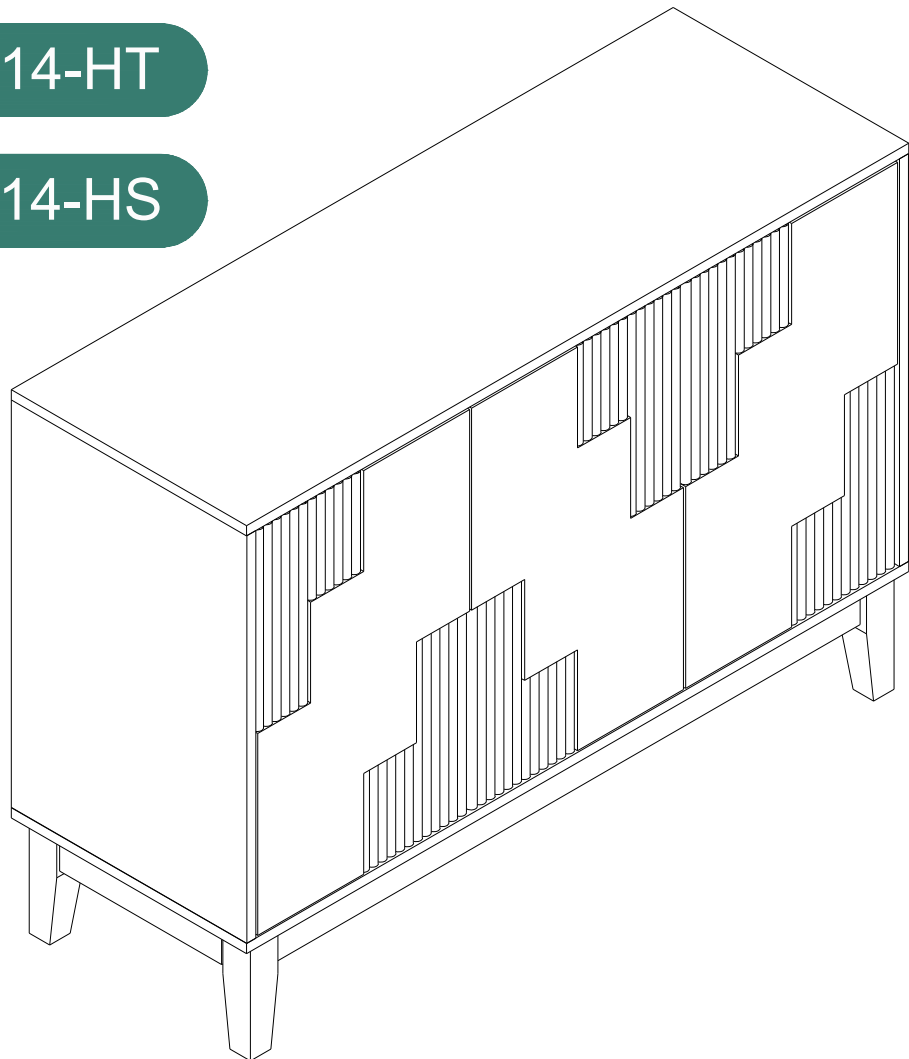

Notice:

1. Follow the installation instructions. Please confirm all accessories are preset before installation.
2. Do not fully tighten the screws during initial assembly. Fully tighten screws only once all pieces which are correctly assembled.
3. If you encounter any problems during installation, please contact our customer service.
4. Please unbox the item from the side with an open-label and put a carpet on the floor to avoid scratching it.

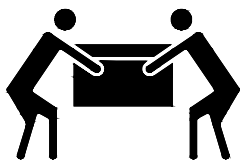

Recommended installers:2

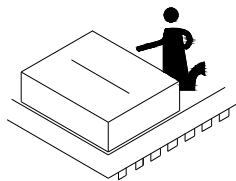

Put a carpet on the floor
before unpacking

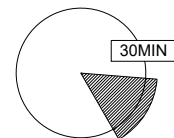

Estimate installation time:
30minutes





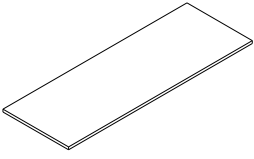
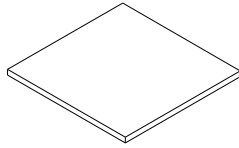
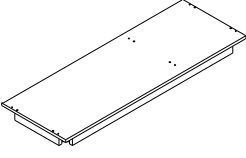
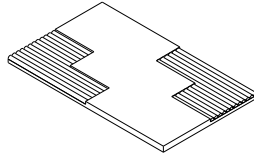
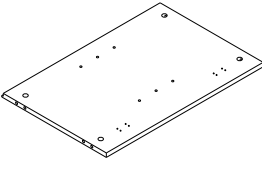
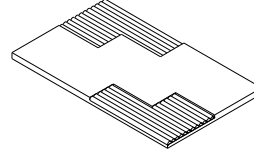
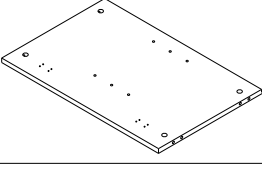
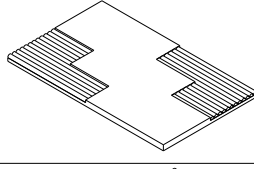
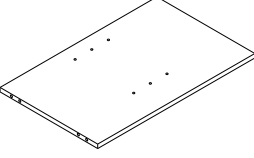
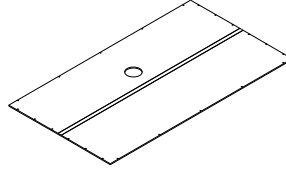
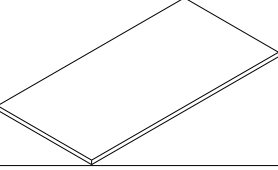
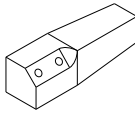

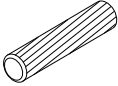
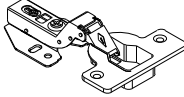

ASSEMBLY INSTRUCTIONS

PART LIST

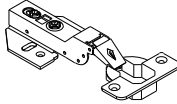
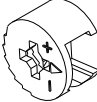
Item no.	Reference Image	Qty	Item no.	Reference Image	Qty
(A)		X1	(G)		X1
(B)		X1	(H)		X1
(C)		X1	(I)		X1
(D)		X1	(J)		X1
(E)		X1	(K)		X1
(F)		X1	(L)		X4

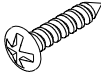
ASSEMBLY INSTRUCTIONS

HARDWARE LIST

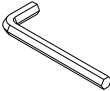
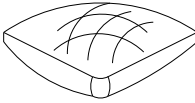
Item no.	Reference Image	Qty	Item no.	Reference Image	Qty
1	 Ø8*30mm	X12+1	7		X4
2		X12+1	8		X2
3		X12+1	9	 Ø3*14mm	X36+3
4	 Ø1/4"*2"	X8	10	 Ø3*15mm	X22+2
5	 Ø1/4"*D12mm	X8	11		X8
6	 Ø1/4"*D16mm	X8	12		X1
			13		X2

ASSEMBLY INSTRUCTIONS

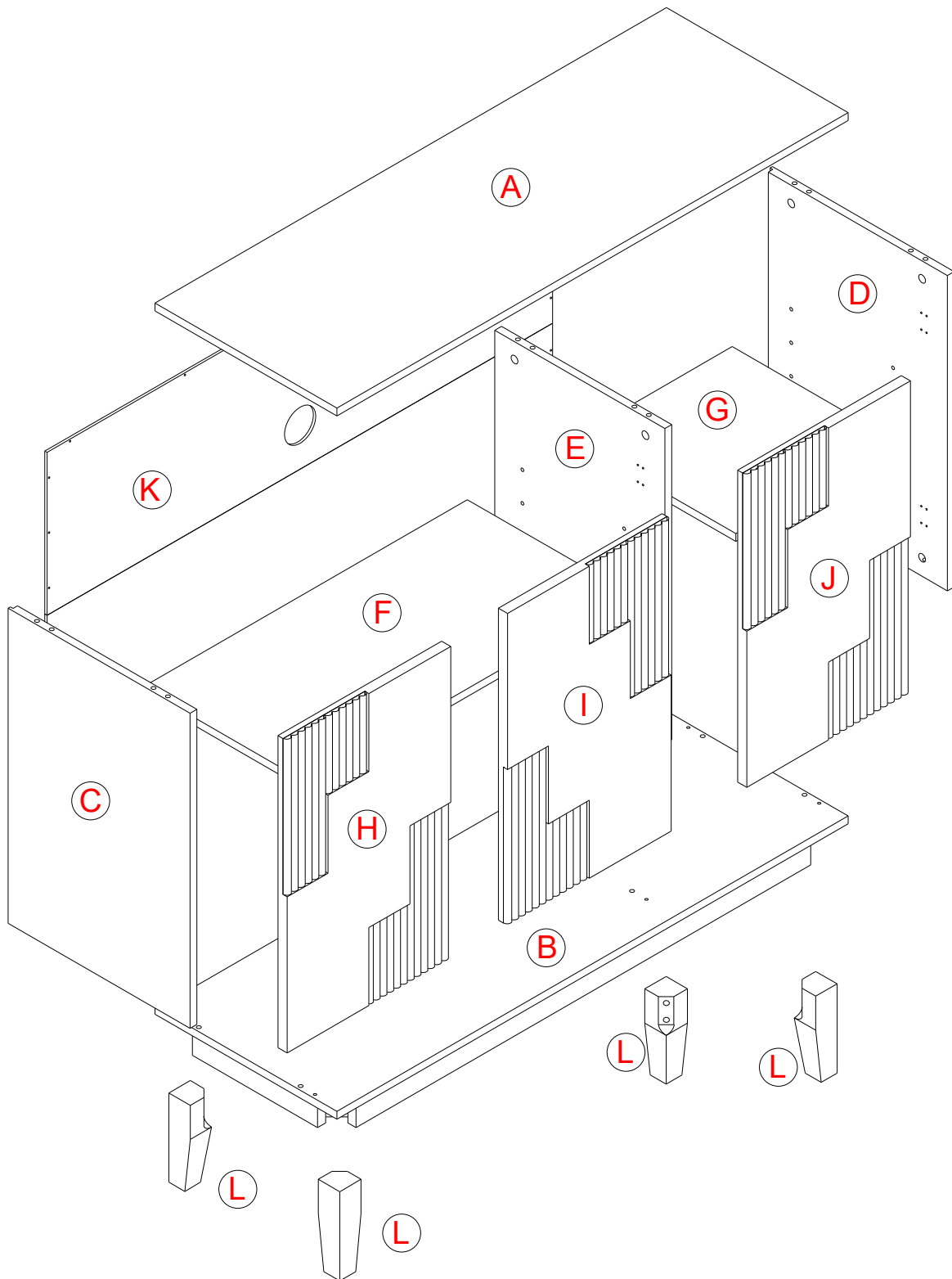

ASSEMBLY INSTRUCTIONS

1

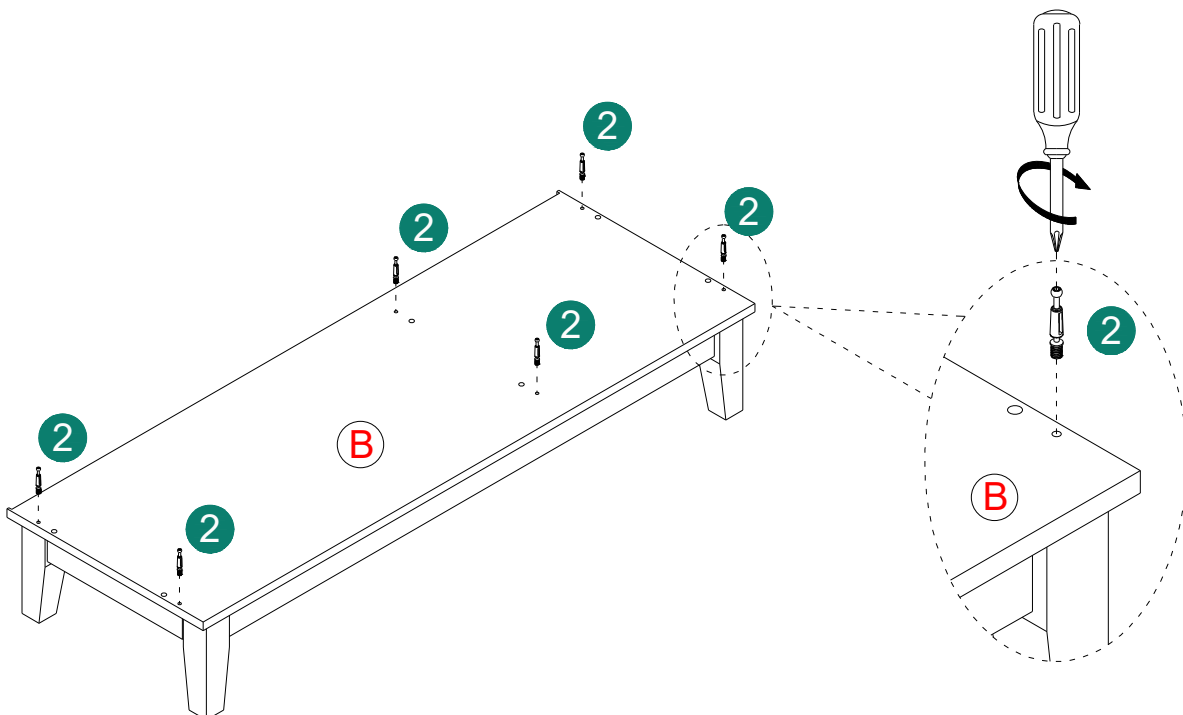
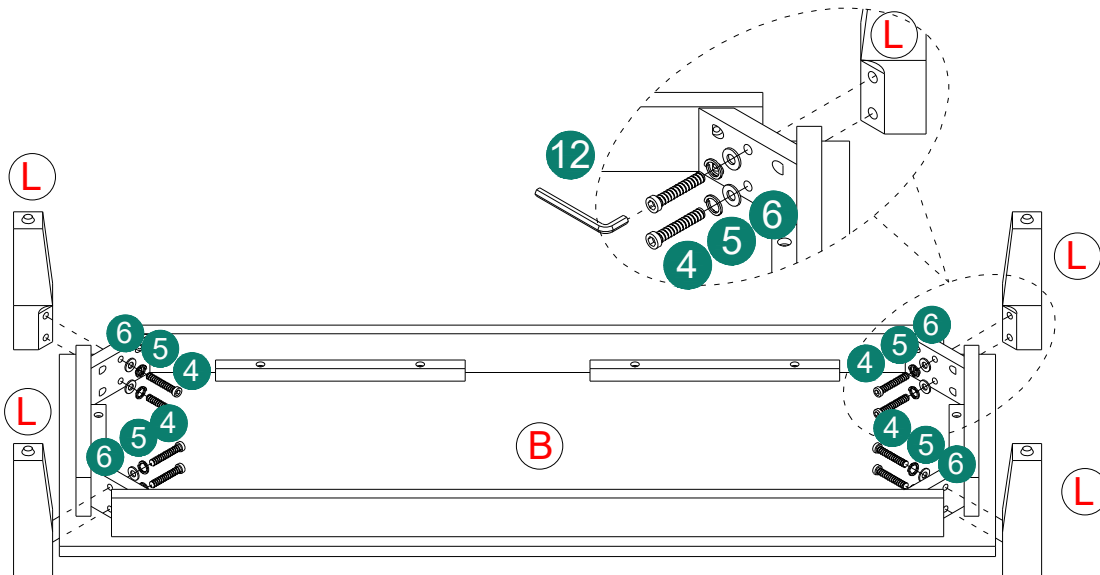
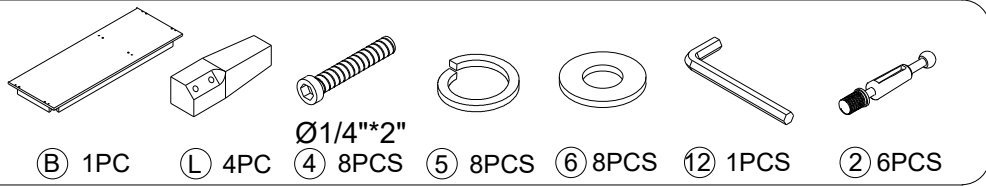

ASSEMBLY INSTRUCTIONS

2

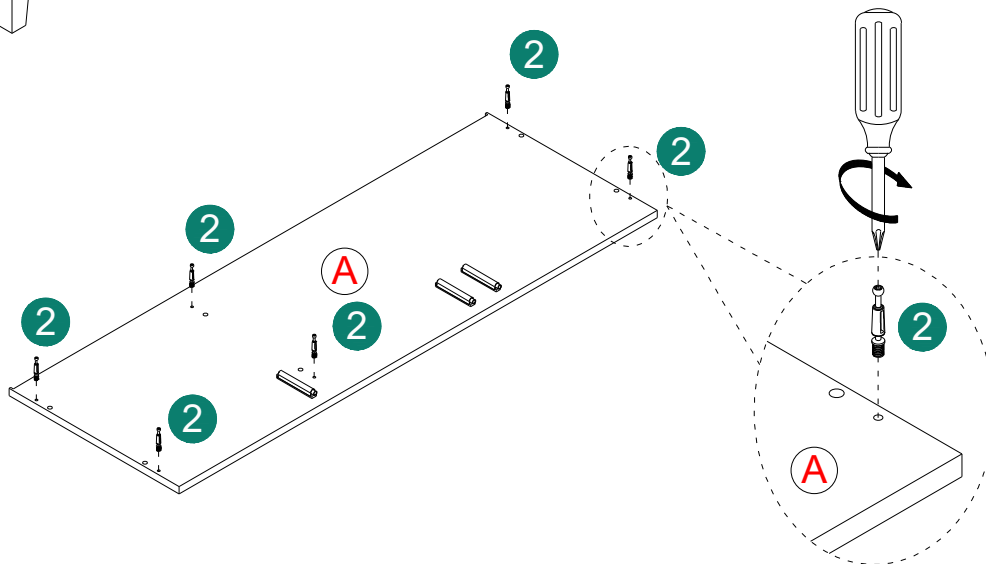
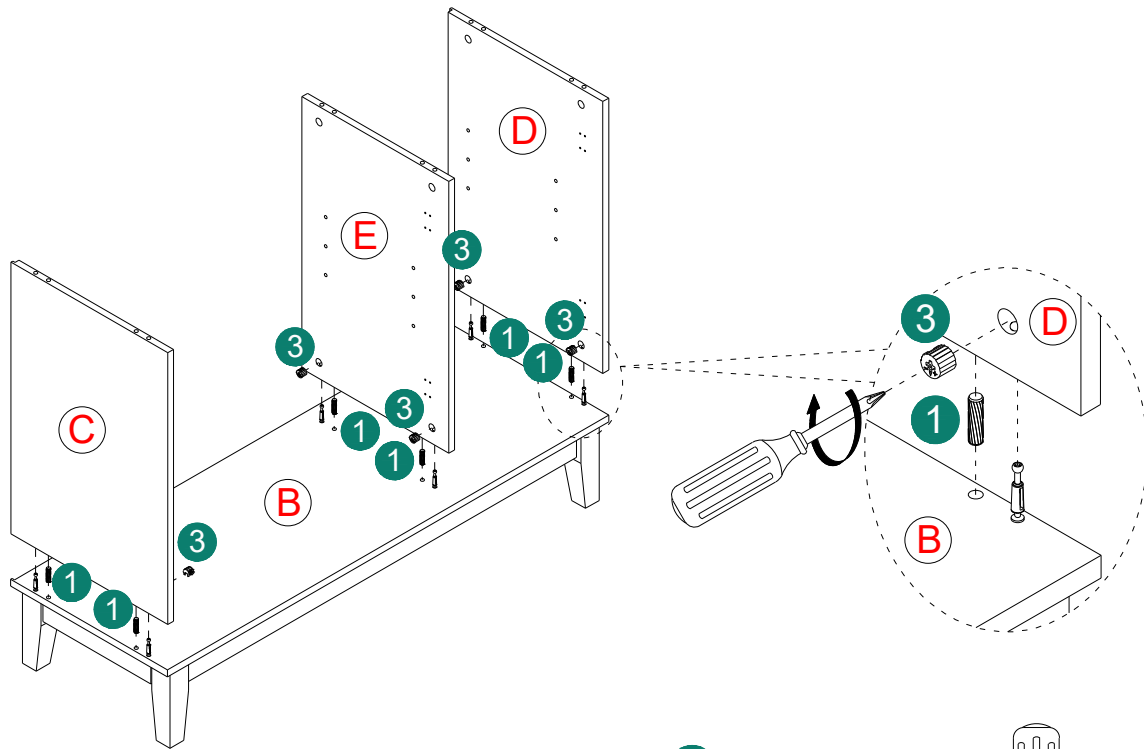
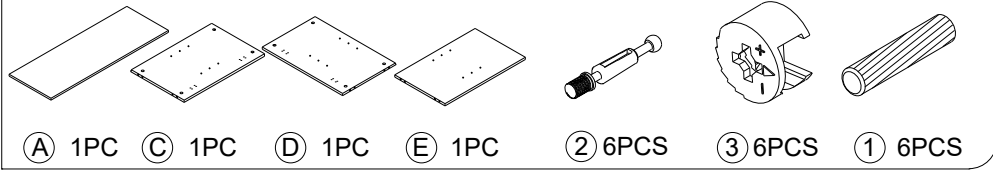

ASSEMBLY INSTRUCTIONS

3

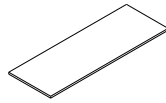

(A) 1PC

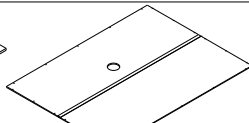

(K) 1PC

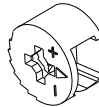

(3) 6PCS

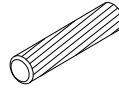

(1) 6PCS

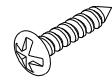

Ø3*15mm
(10) 22PCS

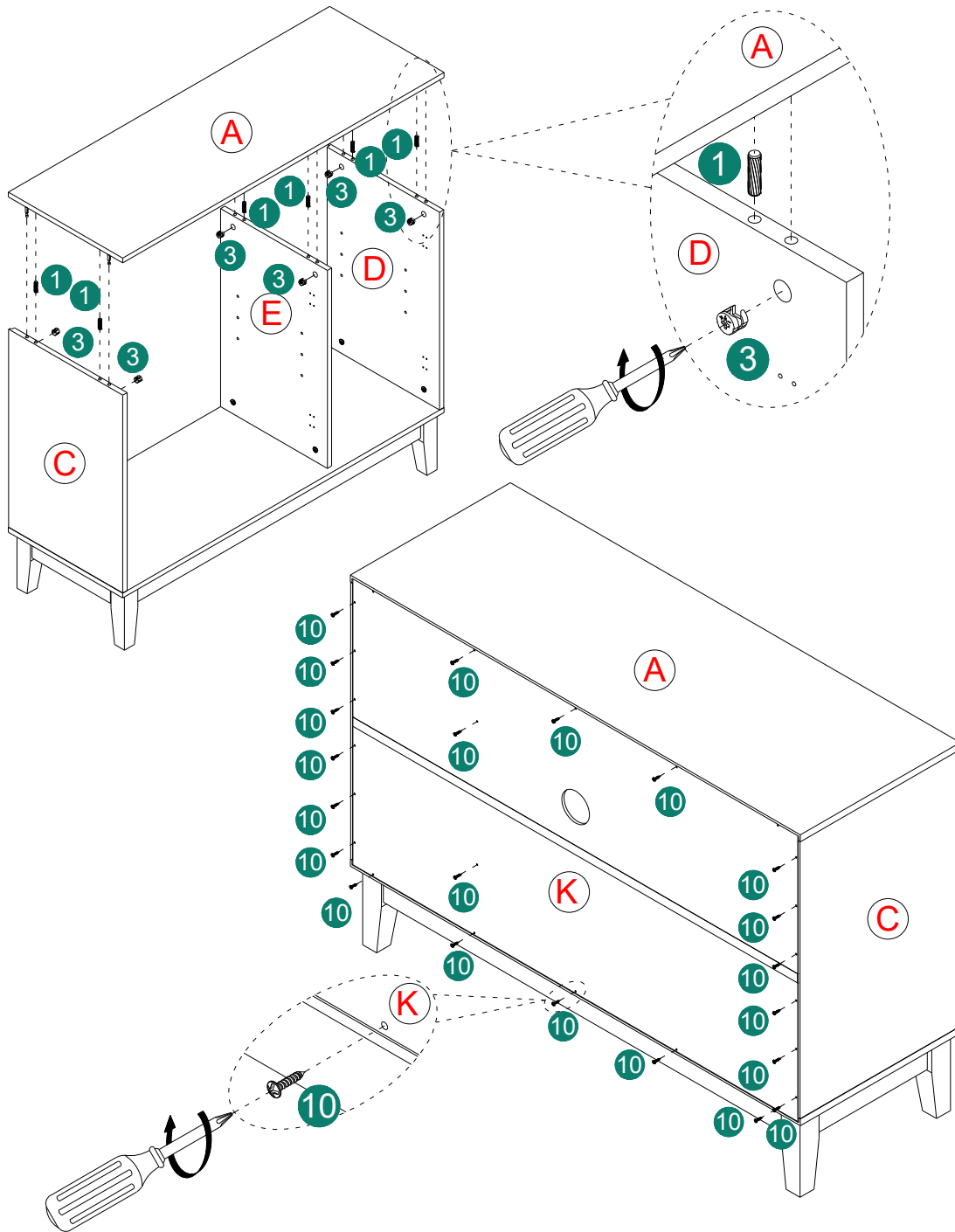

ASSEMBLY INSTRUCTIONS

4

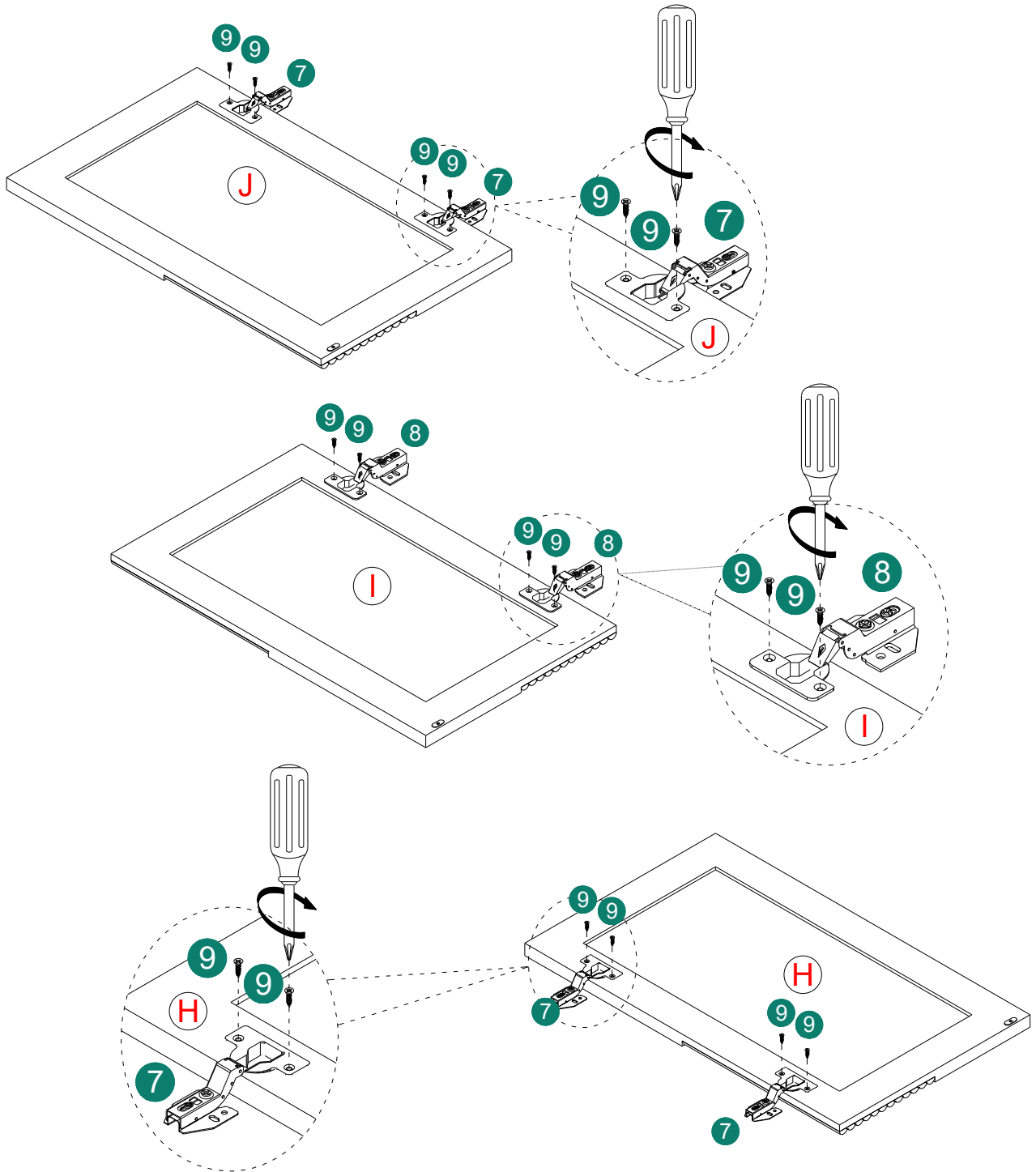
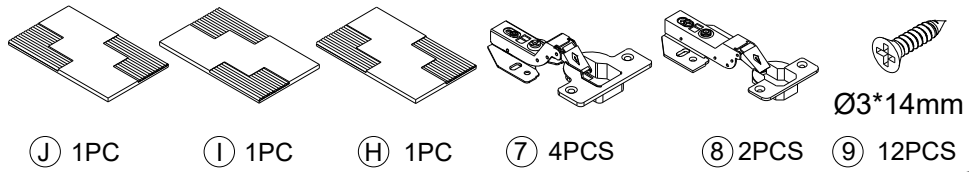

ASSEMBLY INSTRUCTIONS

5

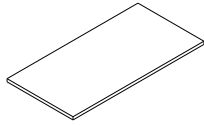

F 1PC

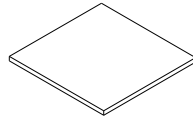

G 1PC



11 8PCS

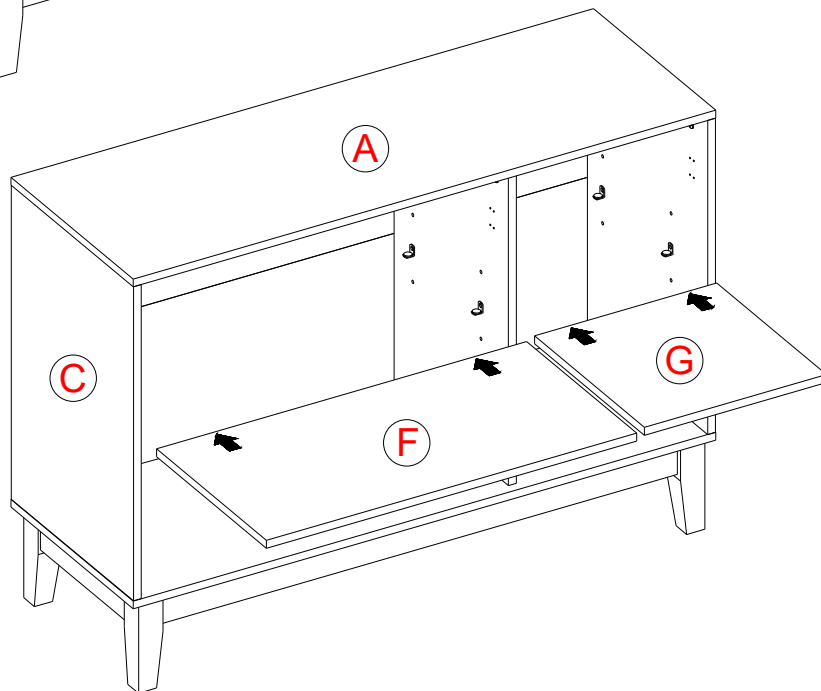
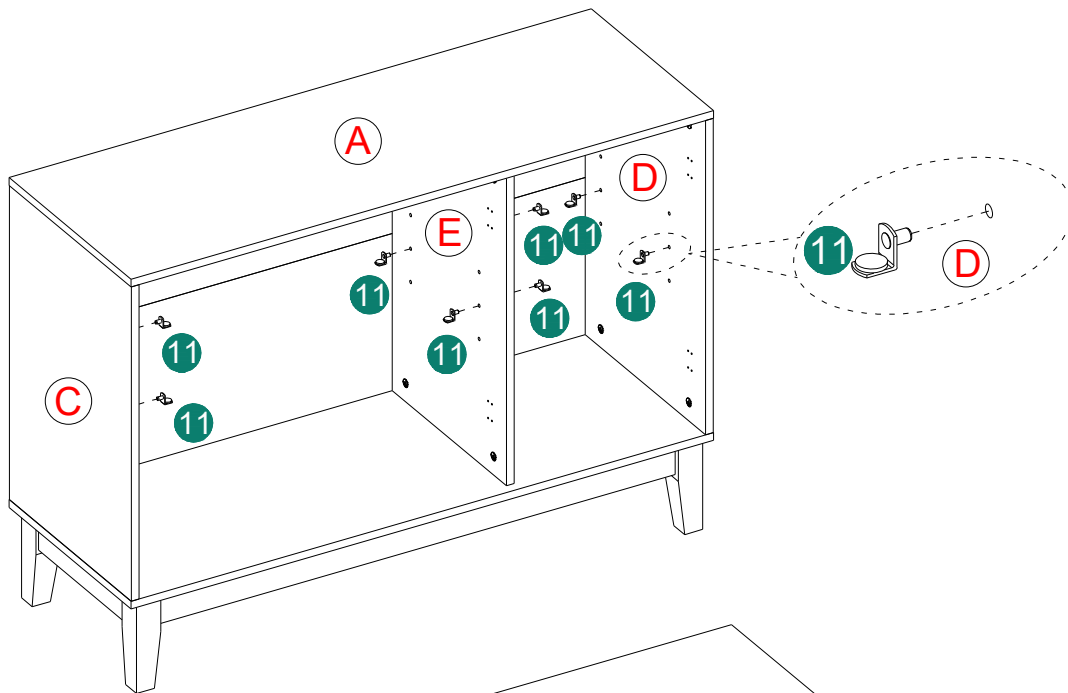

ASSEMBLY INSTRUCTIONS

6

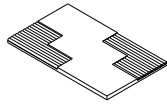

J 1PC

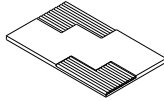

I 1PC

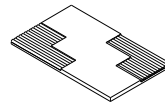

H 1PC



Ø3*14mm

9 24PCS

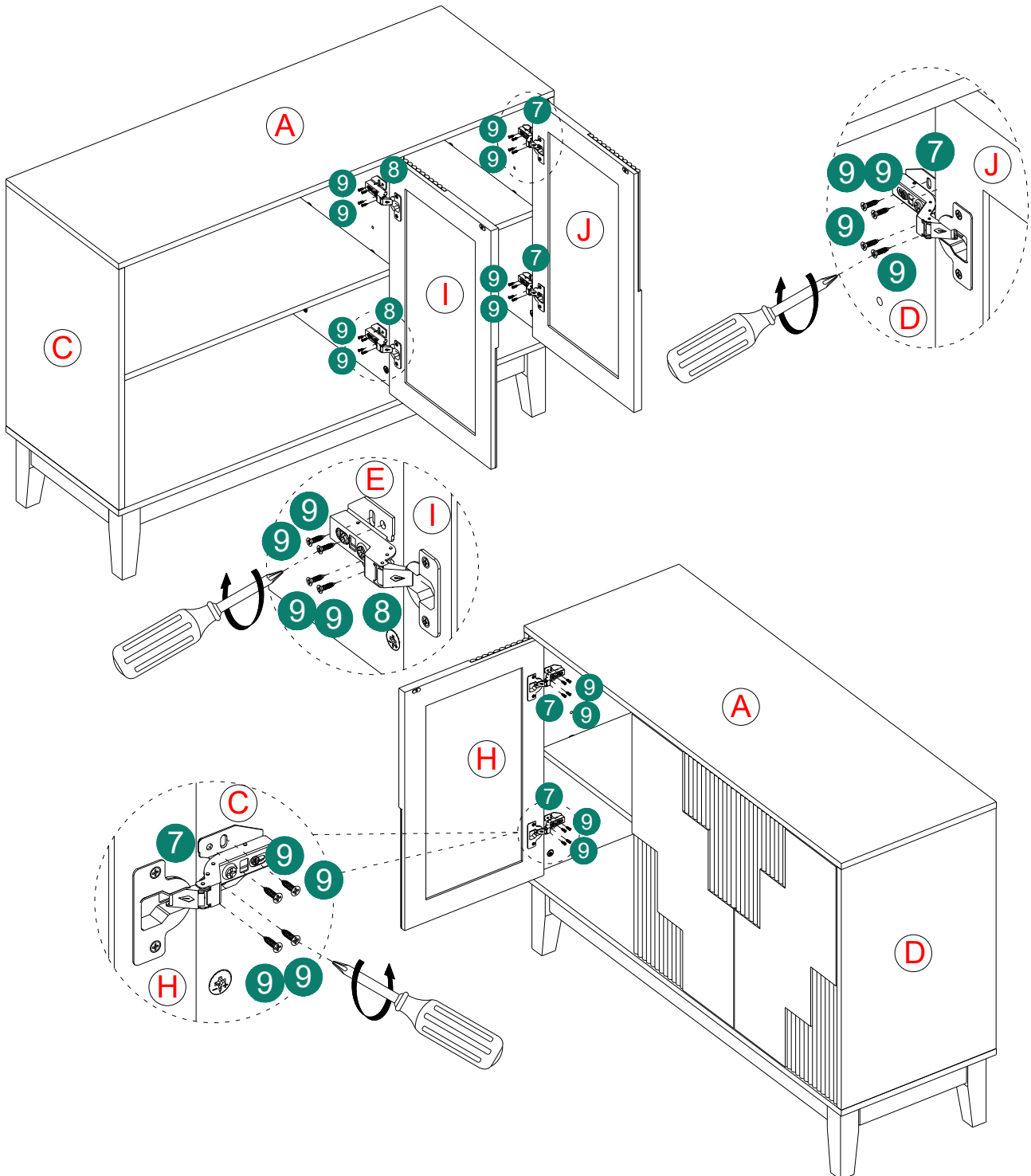

ASSEMBLY INSTRUCTIONS

7

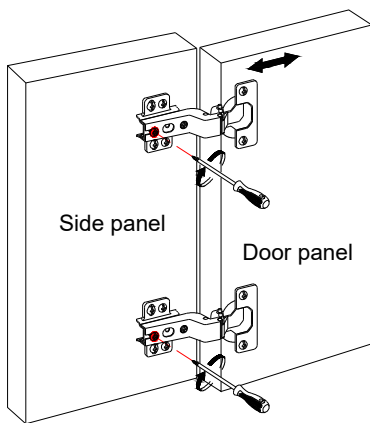

①

Front-to-Back Direction Adjustment:

Rotate the screws on the door hinges shown in the image. The door panel can be moved front-back.

Adjustment range: 4mm

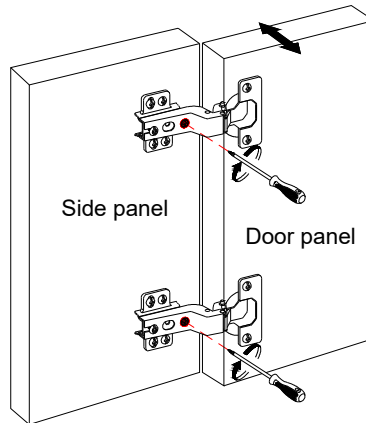

②

Left-Right Direction Adjustment:

Rotate the screws on the door hinges shown in the image. The door panel can be moved left-right.

Adjustment range: 3mm

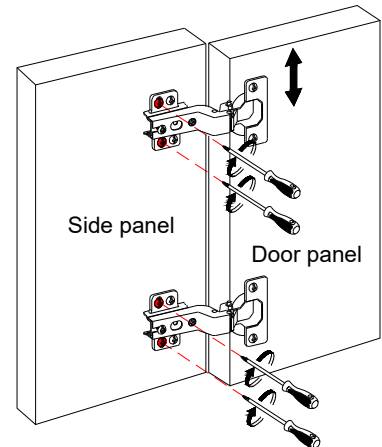

③

Up-Down Direction Adjustment:

Rotate the screws on the door hinges shown in the image. The door panel can be moved up-down.

Adjustment range: 4mm

ASSEMBLY INSTRUCTIONS

8

Common Door Panel Issues:

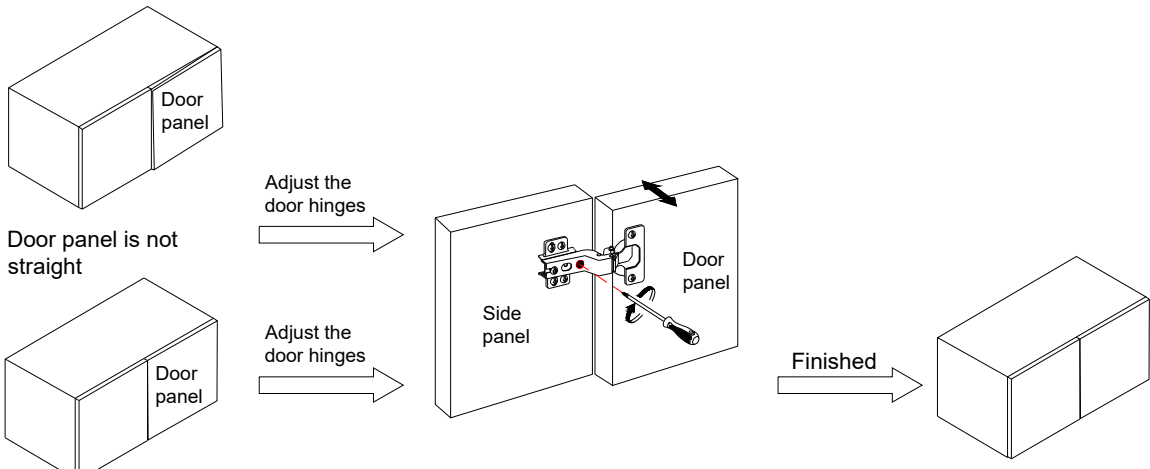

The gap between door panels is too large

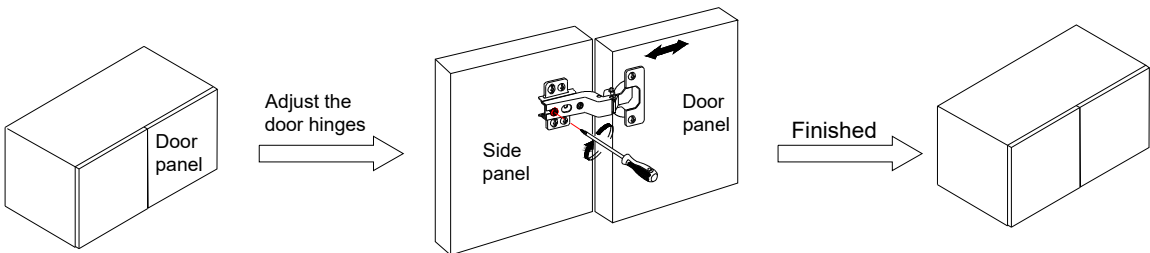

The door panels are not coplanar

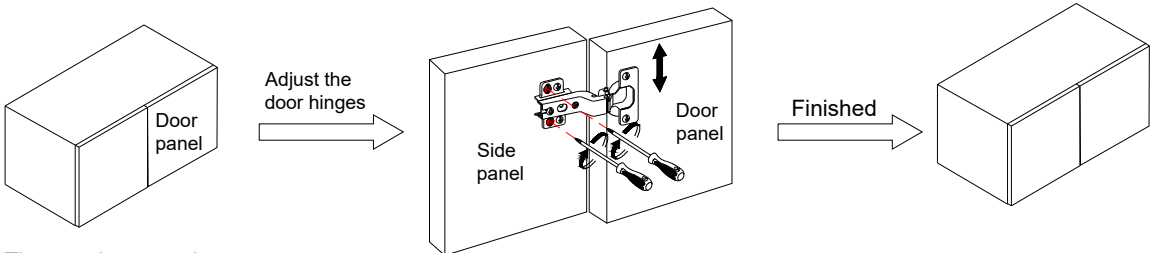

The two door panels are not at the same height

ASSEMBLY INSTRUCTIONS

9

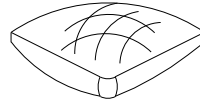

13 2set

A

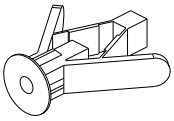

2pcs

B

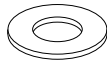

4pcs

C

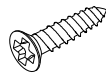

Ø8*3/4"
2pcs

D

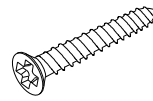

Ø8*1-1/2"
2pcs

E

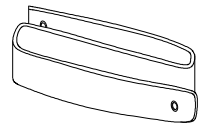

2pcs

