











Assembly Instructions

Caution : You must read this before you proceed

Care & Maintenance

- ⊘  ● Not for commercial use. For residential use only.
 - ✓  ● Furniture may scratch floors. We recommend using furniture pads to protect your floors.
 - ⊘  ● Do not put hot items directly on furniture surface.
 - ⊘  ● Do not clean furniture with harsh cleansers or polish.
 - ⊘  ● Do not place furniture under direct sunlight.
 - ⊘  ● Do not place furniture near heating or cooling vents.
 - ⊘  ● Do not write on furniture without a padded barrier to protect the surface.
 - ⊘  ● Do not place furniture outside . For indoor use only.
 - ⊘  ● Stains may be removed with mild soap solution and damp cloth.
 - ⊘  ● Children should not climb or jump on the furniture.
-
- ✓  ● Dust and pick-up spills using a clean, non-colored, lint-free cloth.

Please look in SOFA for hardware packs and legs.
Sets often ship in multiple boxes and may arrive a day or two apart.

SOFA

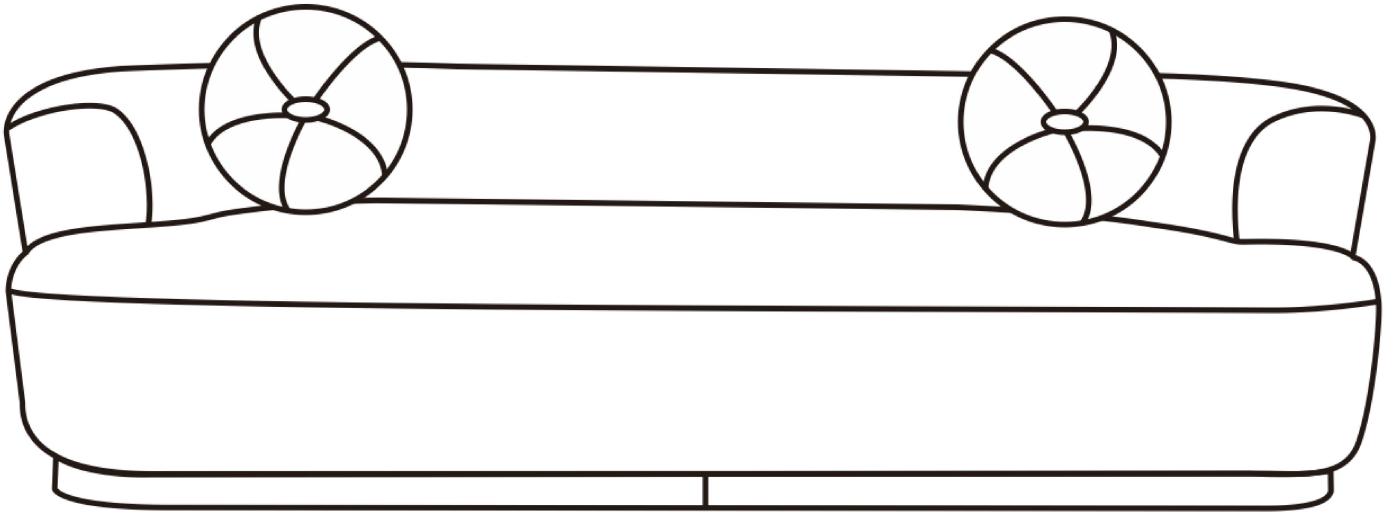





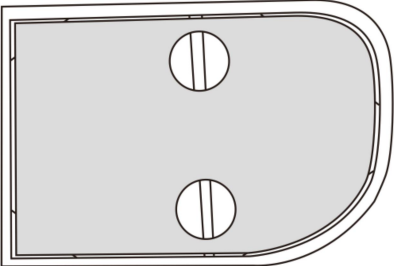

Parts List

Label	Picture	Description	QTY
A	A line drawing of a foam sofa, showing the main body of the sofa without the cushions.	Foam Sofa	1
B	A line drawing of a round cushion with a central button and four curved segments.	Cushion	2
C	A line drawing of a left wooden base frame, showing a rectangular shape with rounded corners and two circular holes.	Left Wooden Base Frame	1

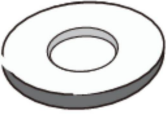
D		Right Wooden Base Frame	1
---	---	-------------------------	---

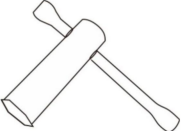
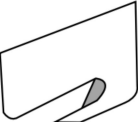
Hardware

Label	Picture	Description	QTY
①		Single Head Screw(M8×70mm)	3
②		Nut(M8)	3
③		Gaskets (M8*18mm)	5
④		Spring Shims(M8)	5
⑤		Wrenches	1
⑥		Blades	1
⑦		Allen Wrench(M8)	1

Assembly Preparation

Before Beginning Assembly:



A x 1



B x 2

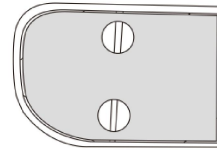

C x 1

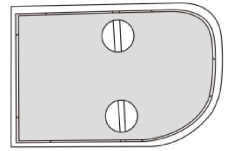

D x 1



① x 3



② x 3



③ x 5



④ x 5

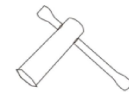

⑤ x 1

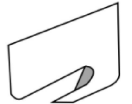

⑥ x 1



⑦ x 1



- Read instructions, cover to cover-



- Have 2 adults on hand for assembly-



- Do not assemble on flooring or carpet-



- Assemble on a clean non-marring surface (packing foam)-



- Save all packaging until finished-

Assembly Steps

Overview

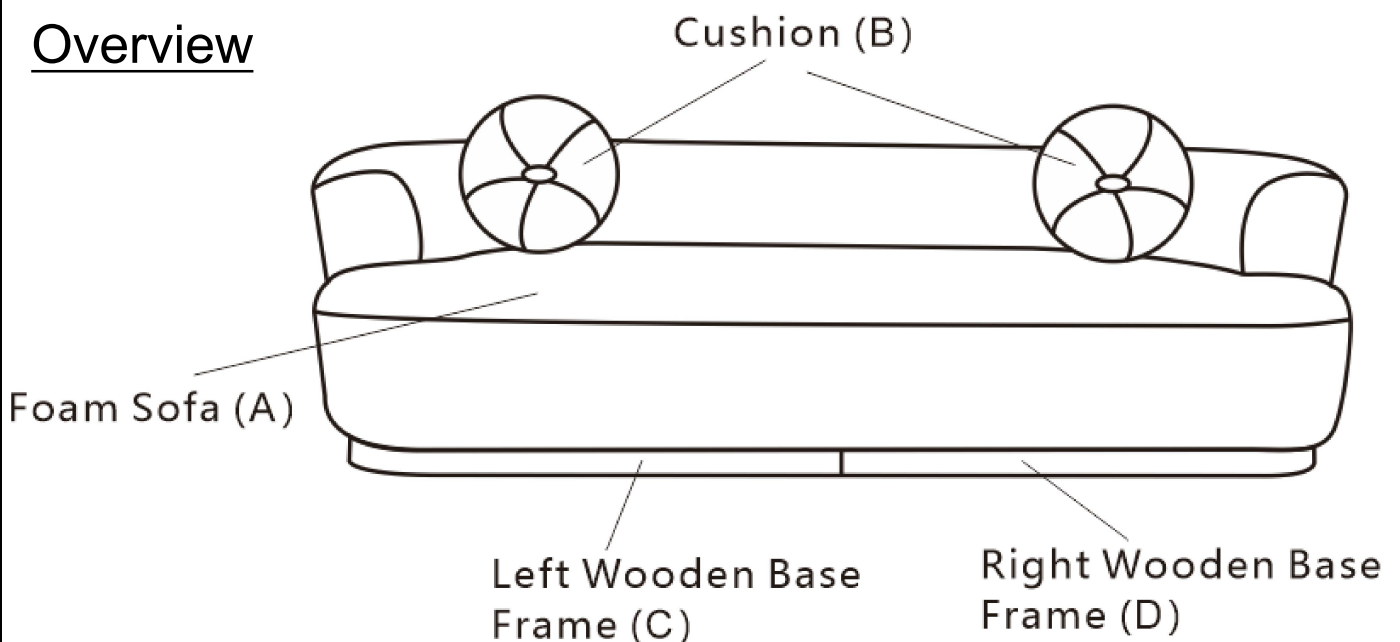

This Sofa has multiple parts and may require up to some 30 minutes to assemble.

To give you an overview of the Sofa parts, the above picture is to help you put the various parts into perspective.

Please read through the instructions below to familiarise yourself with the parts and steps before assembly.

Note: It is recommended that you have an adult partner to assist during the entire assembly process.

Step 1

Cardboard box 2-1

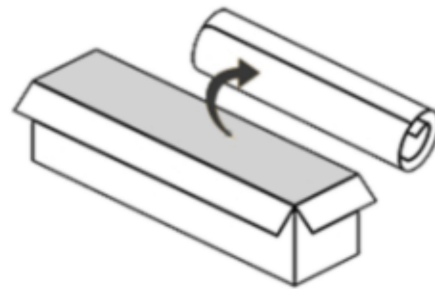

Remove the compressed package from the cardboard box.

Step 2

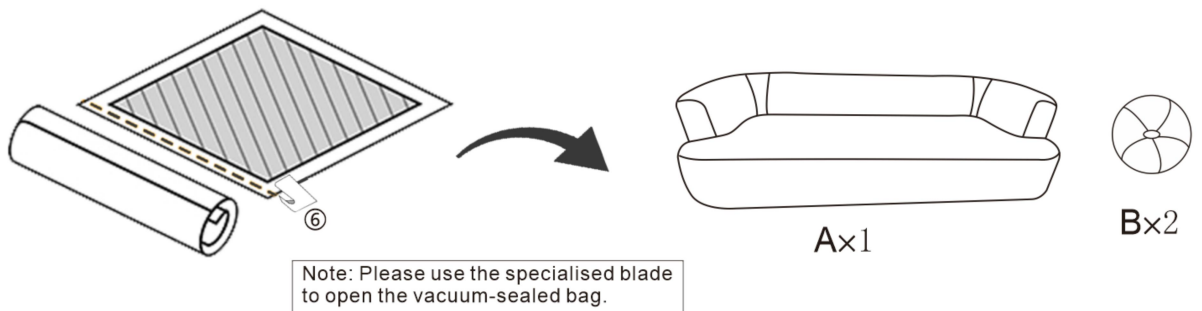

Unfold the compressed sand evenly, cut along one edge of the packaging using a blade, remove Foam Sofa (A) and Cushion (B), and place them on a clean, flat, scratch-free surface.

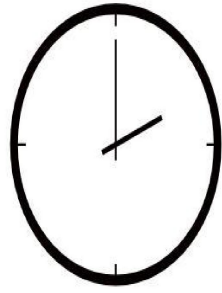

... Wait **72h**

After opening the compression bag (Note: Please do not cut with a knife, so as not to damage to the product), the corners around the cushions if there are wrinkles, you need to wait for about 72 hours, it is recommended that guests pat and knead the corners of the sofa, in order to sponge better recovery.

If you need any help, please take a picture and contact the seller.

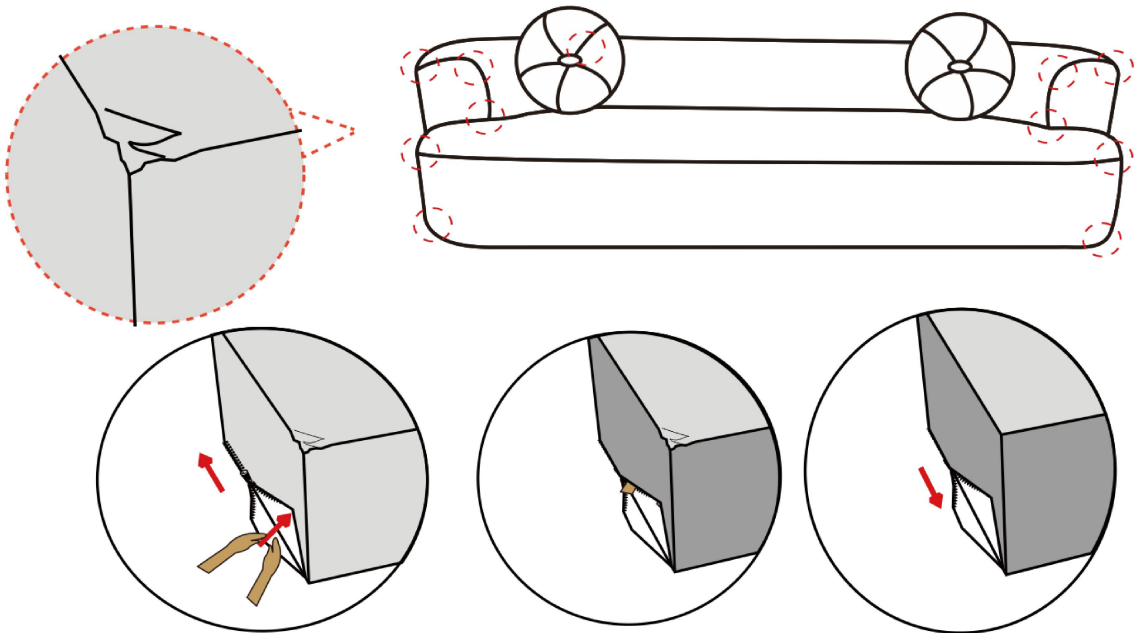

If you see the folds, Unzip the bottom of the product, Put your hand in, Gently pat and knead to tidy up the increased sponge, Wait for the sponge to become full and flat before Zip up the bottom of the product.

Step 3

Cardboard box 2-2

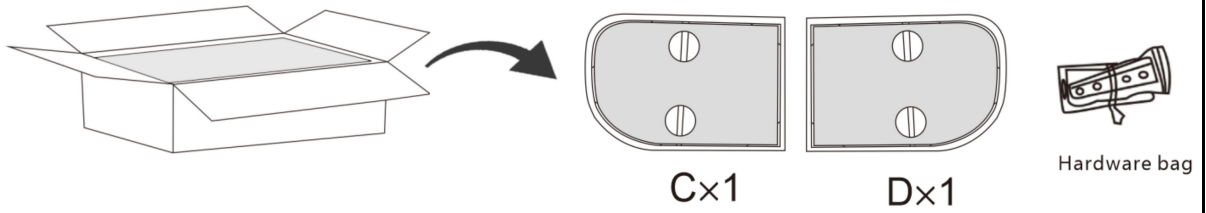

Remove Left Wooden Base Frame (C) and Right Wooden Base Frame (D) along with the hardware accessories bag from carton 2-2, and place them on a clean, flat surface free from scratches.

Step 4

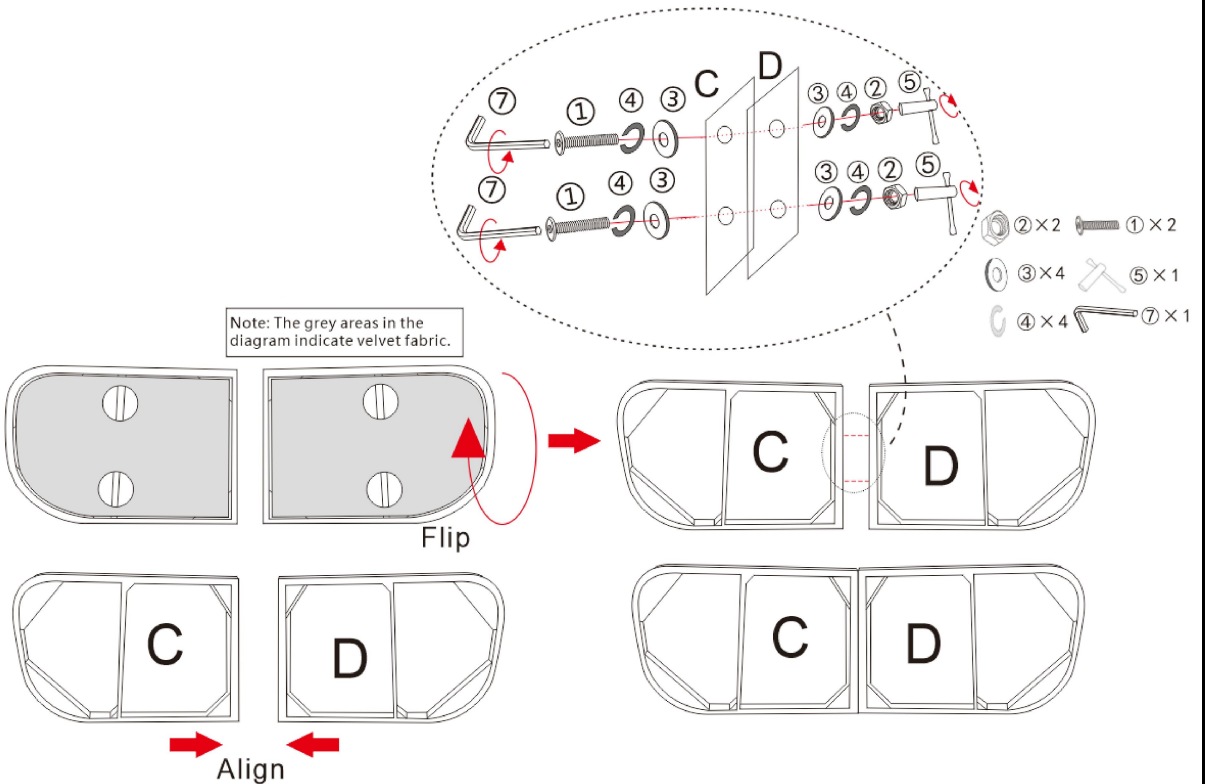

Turn Left Wooden Base Frame (C) and Right Wooden Base Frame (D) over to their reverse sides.

As shown in the figure: Align the holes on both sides of the Left Wooden Base Frame (C) with those on the Right Wooden Base Frame (D). Secure them together using a Single Head Screw (①), Spring Shims (④), and Gaskets(③) on the left side, and a Spring Shims (④), Nut (②), and Wrenches(⑤) on the right side.

Step 5

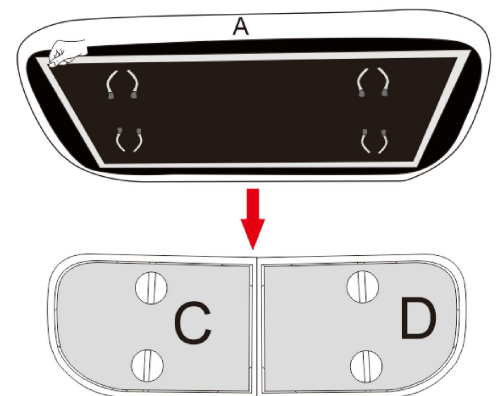
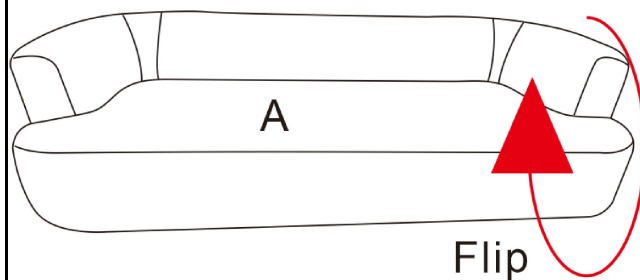

Flip component Foam Sofa (A) over, peel back the Velcro backing underneath, and align the Velcro strip with the corresponding strip on the base frame as shown. Position Foam Sofa (A) over components Left Wooden Base Frame (C) and Right Wooden Base Frame (D), ensuring proper alignment.

Step 6

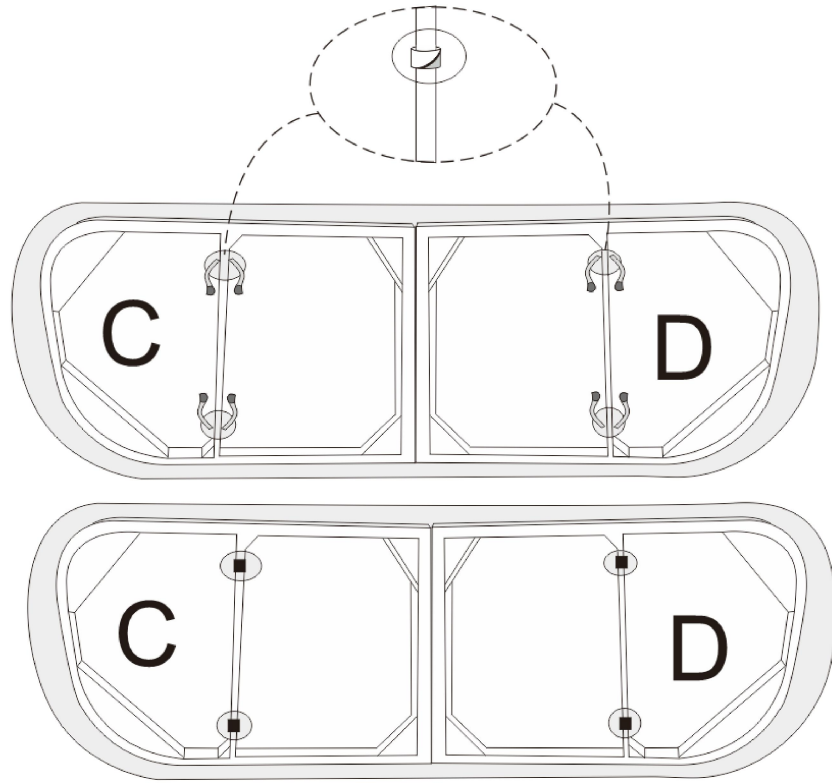

Thread the Velcro strap through the holes and wrap it tightly around the base wooden strip.

Step 7

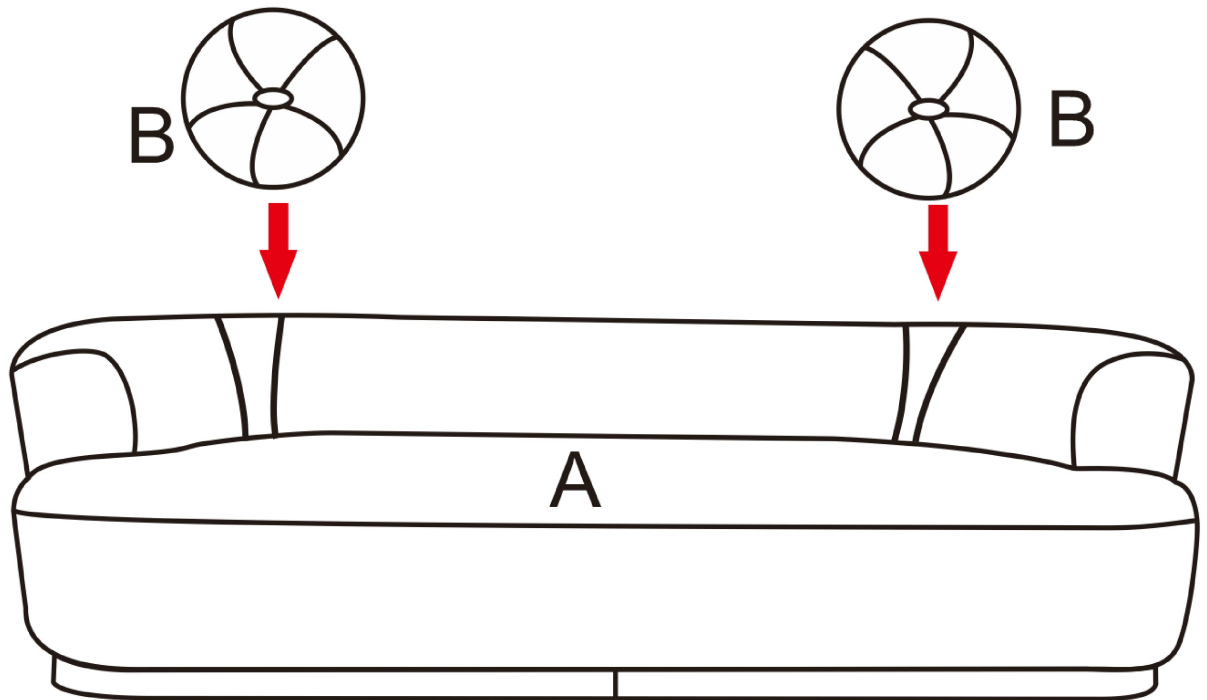

Place Cushion (B) on the sofa.

Step 8

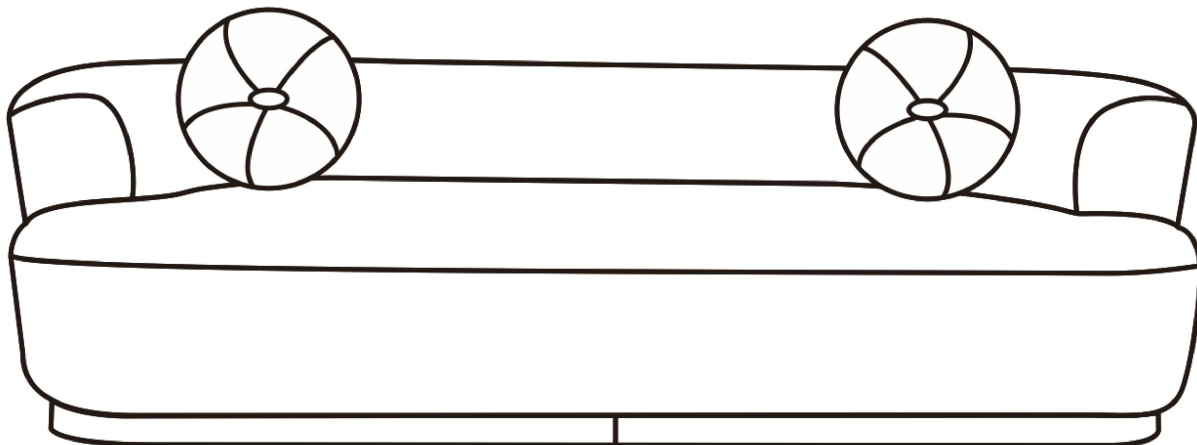

Your sofa is ready for use.

This sofa should only be used on flat, level surfaces.