

ASSEMBLY INSTRUCTIONS

BATHROOM VANITY TOP

✉ support@trendytotesinc.com
☎ 213 675 2021



PRODUCT
INSTRUCTION
VIDEO

MODEL 48F Vanity Top

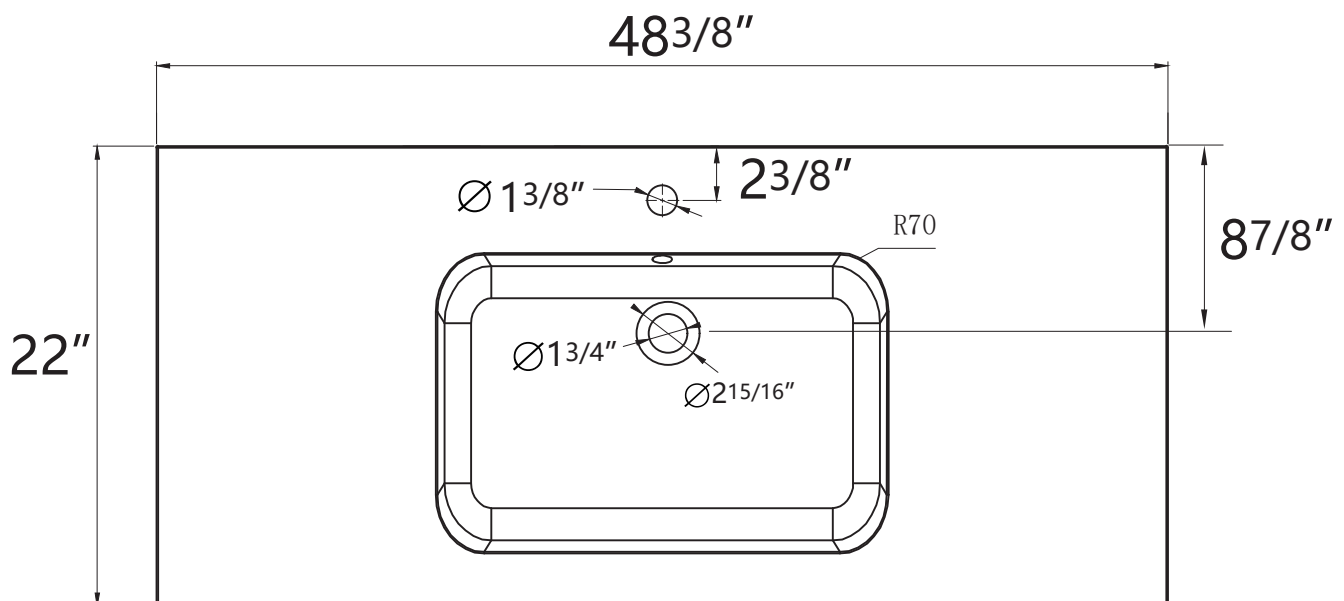



NOTE: Any size of the vanity's installation steps are the same.

INSTALLATION STEPS

1. Prepare the Vanity: Make sure the vanity is in place and securely attached to the wall.

2. Seal the Edges: To prevent water damage and ensure a clean finish, apply a bead of silicone caulk along the edges where the countertop meets the vanity.

(For Example)

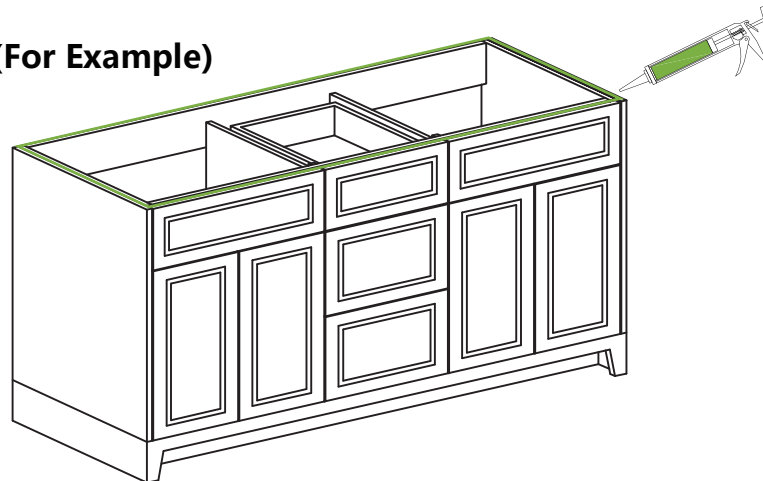

3. Attach the Countertop: Secure the solid surface countertop on the vanity.

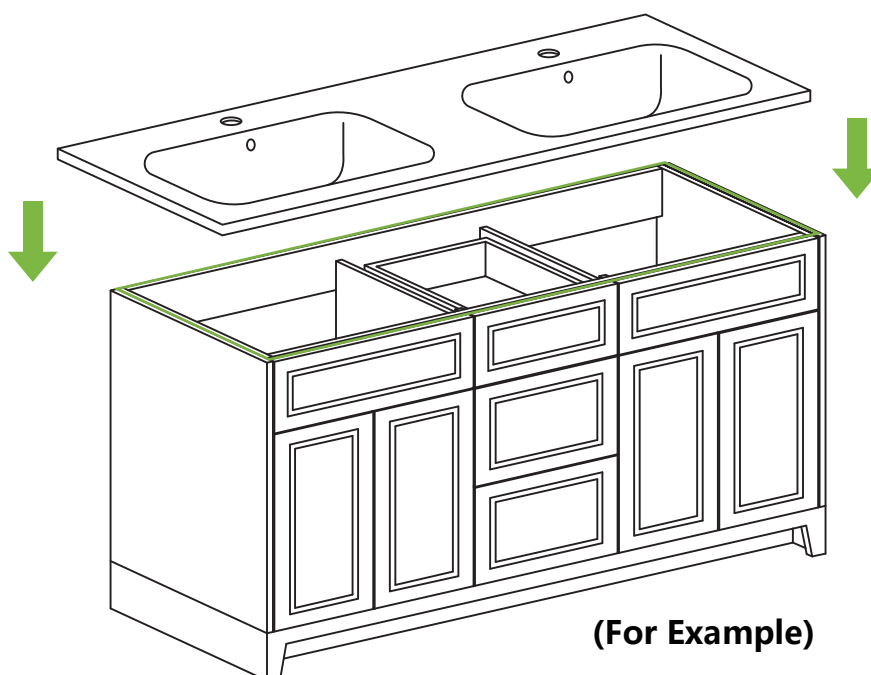

(For Example)



HOME SERVICES



INSTALLATION VIDEO

Missing Part or Defective?

Please Contact the Customer Service Team

 support@trendytotesinc.com