

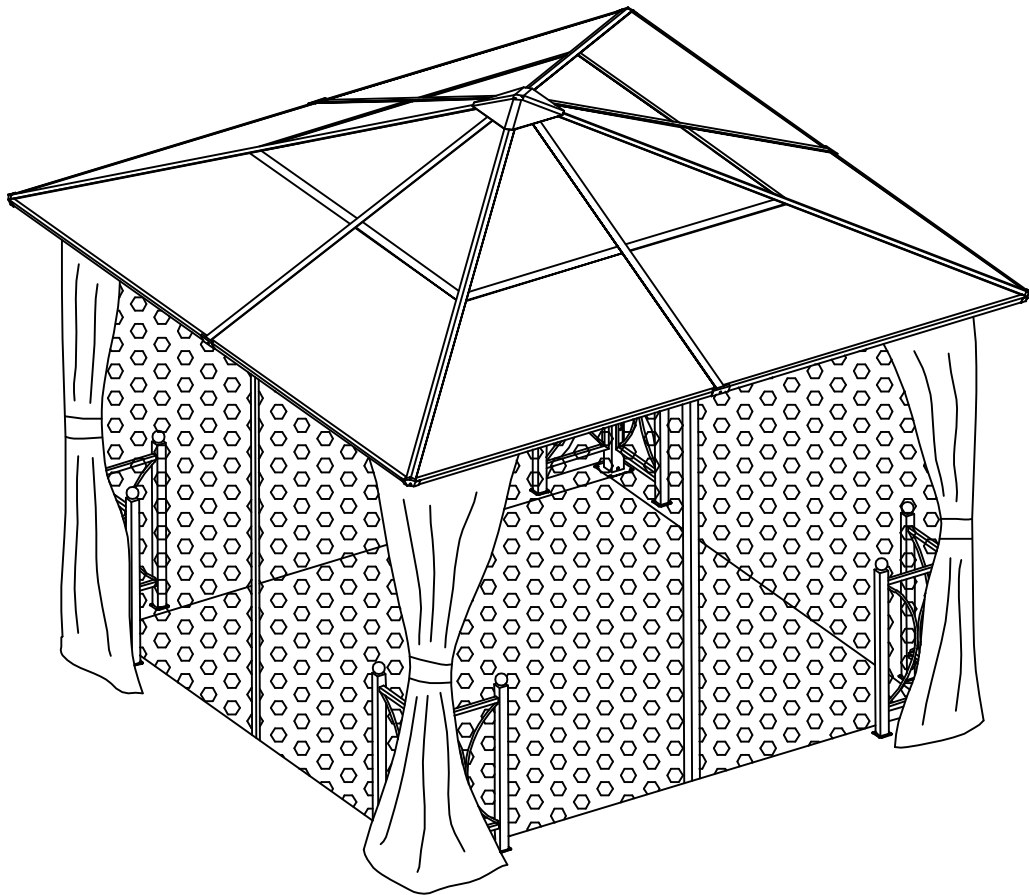

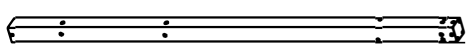





ASSEMBLY INSTRUCTION

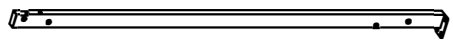
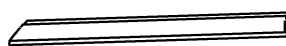
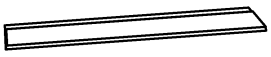
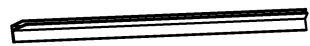
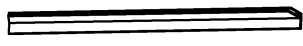

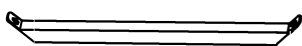
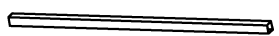
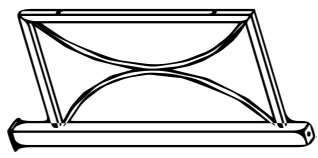
2

 (A) 4x	 (B) 4x
 (C) 4x	 (F) 4x
 (G) 4x	 (I) 4x
 (J) 4x	 (L) 4x
 (M) 4x	 (N) 12x
 (O) 8x	 (P) 8x
 (Q) 4x	 (R) 4x
 (U1) 8x	 (U2) 8x



M6*15

X1 128x



M6*40

X2 16x



M6*30

X3 16x

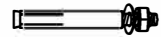

X4 12x

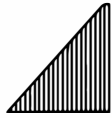

1 4x

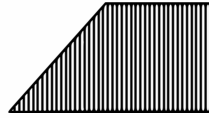

2 4x

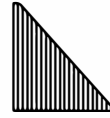

4 4x

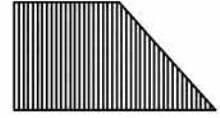

5 4x



6 4x

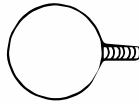

7 8x



8 4x



10 4x

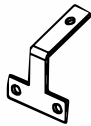

12 4x

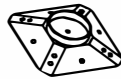

13 1x

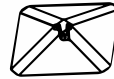

14 1x



15 4x

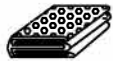

16 4x



18 8x



20 144x



21 5x



S4

1x

REQUIRED TOOLS



<1>

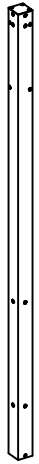

A 4x



8 4x



M6*15



X1 8x

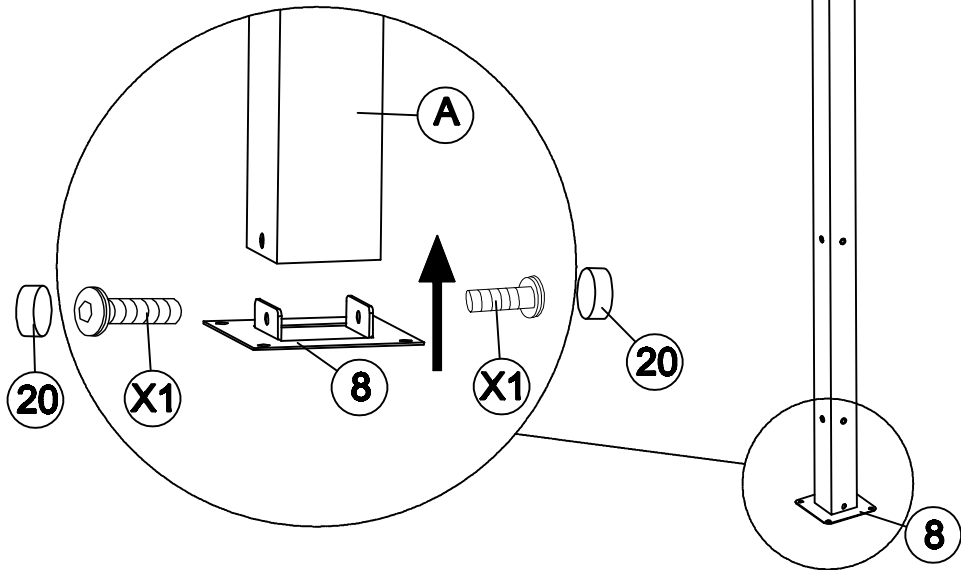

20 8x

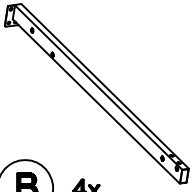
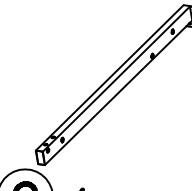
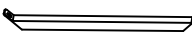

<2>

- **B** 4x
- **C** 4x
- **N** 8x
- 
M6*15
X1 40x
- **20** 40x

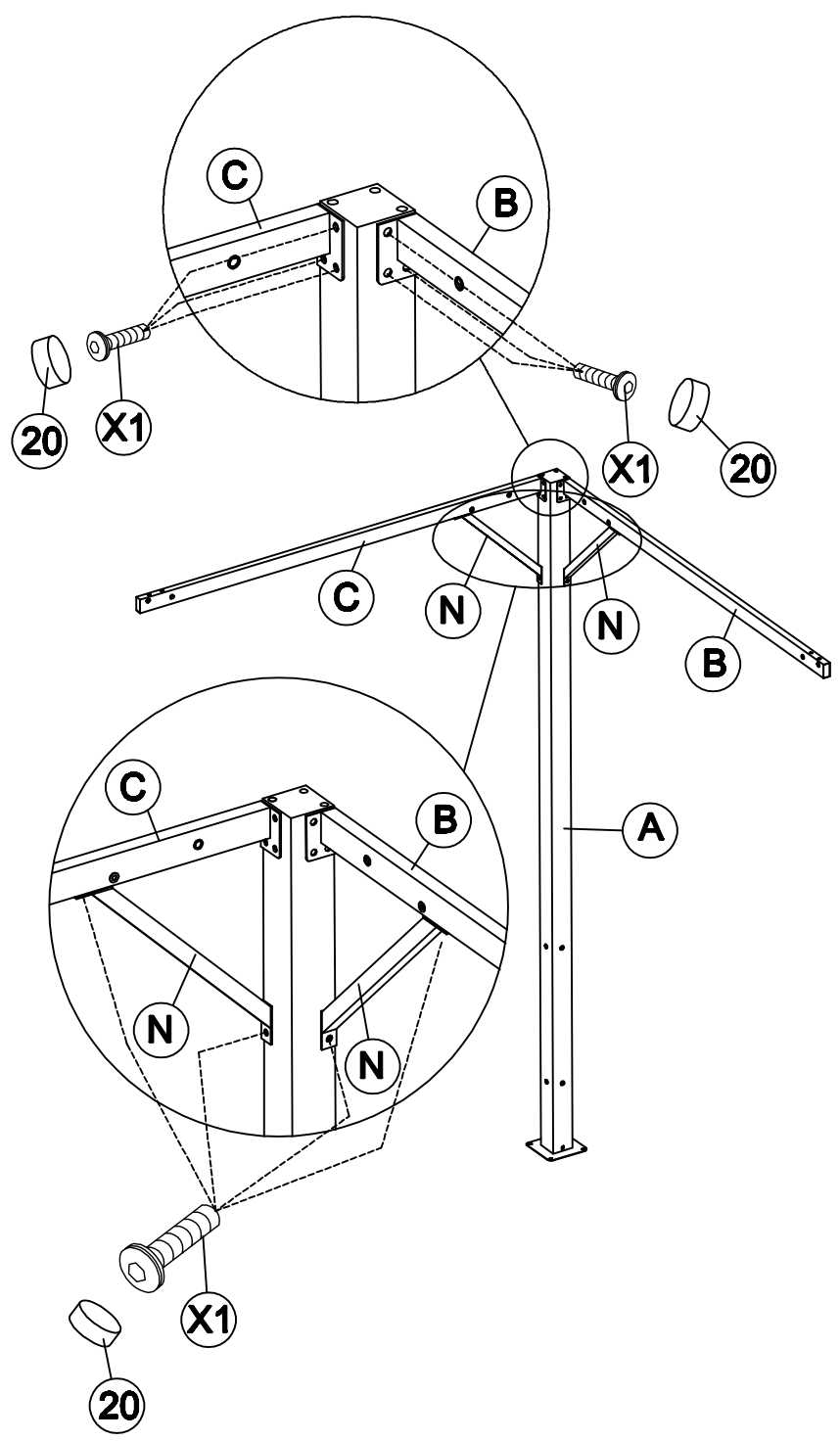

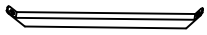

N 4x

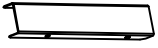

10 4x



M6*15

X1 32x



20 32x

<3>

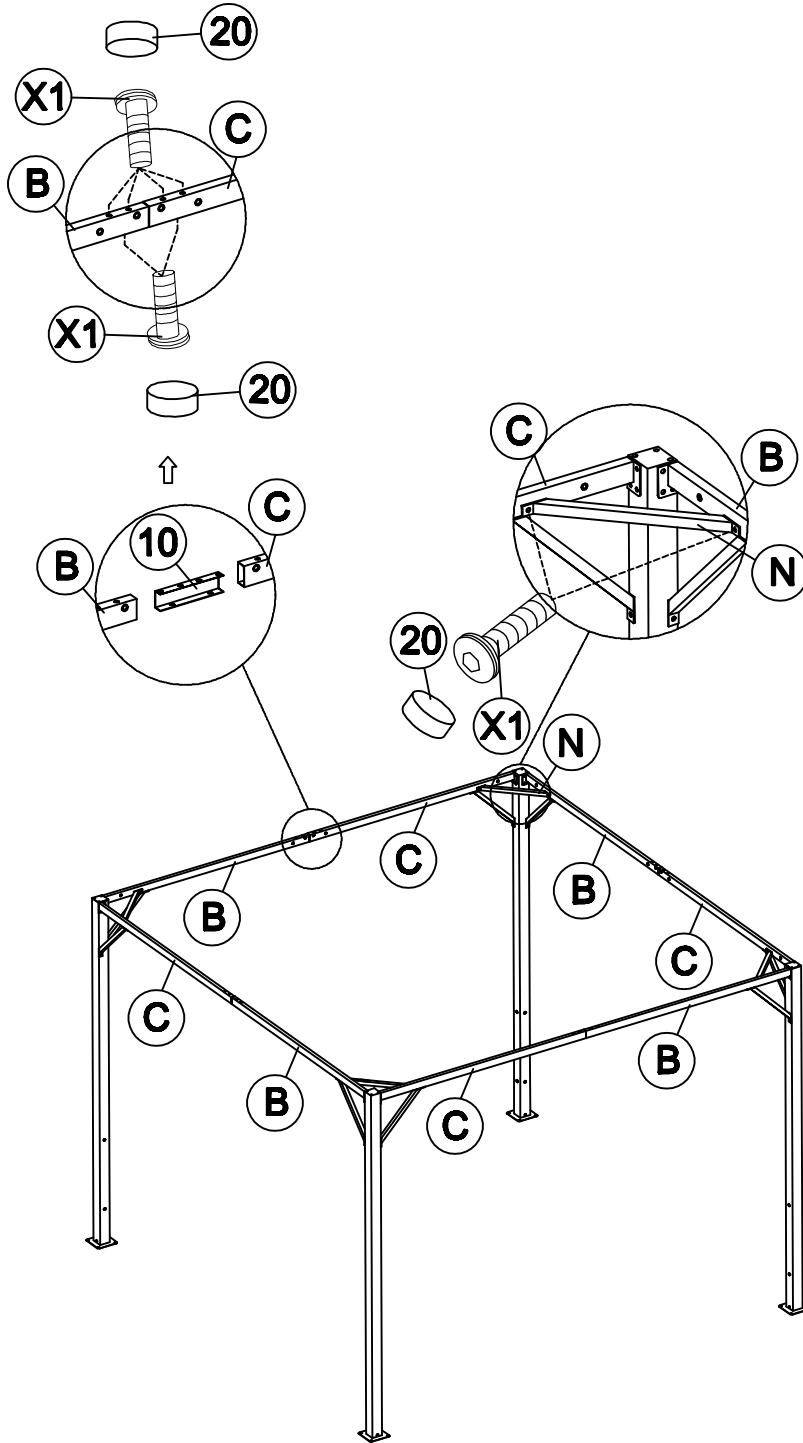

6

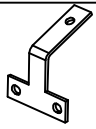

12 4x



X1 8x



20 8x

<4>

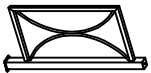
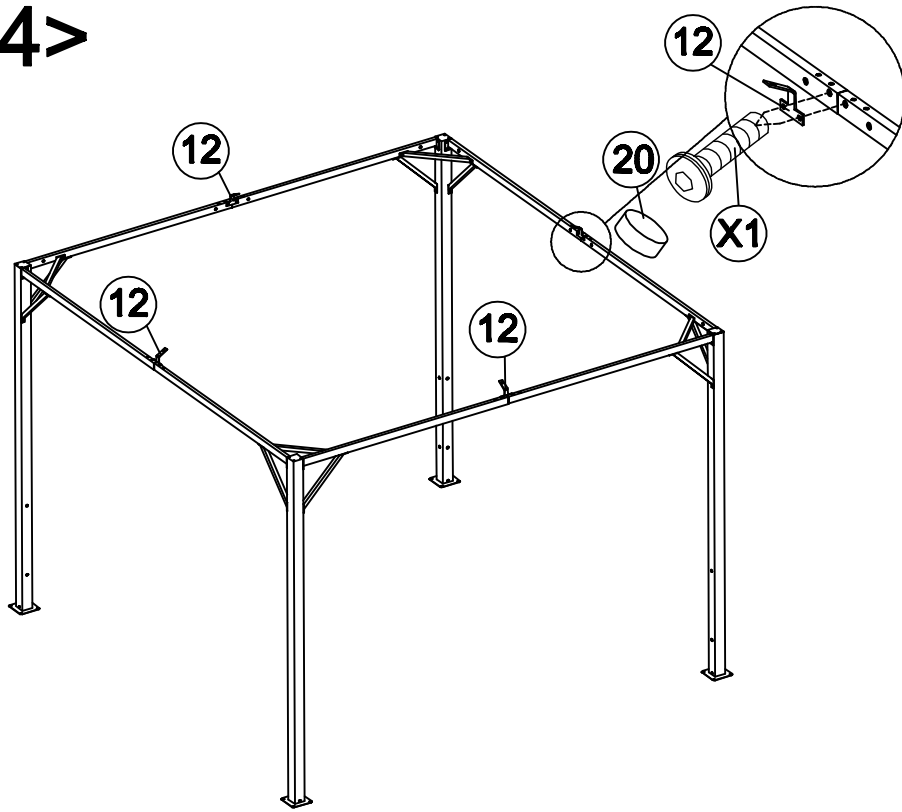

P 8x



X3 16x



20 16x

<5>

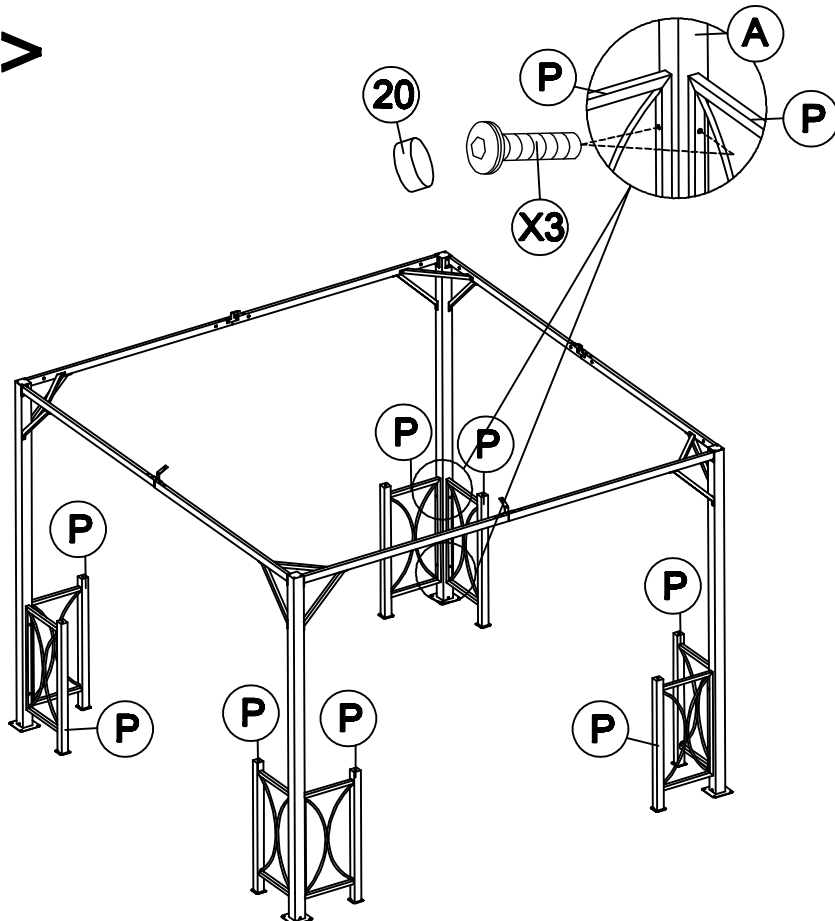

7

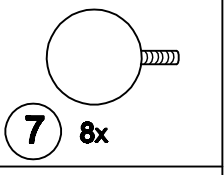

<6>

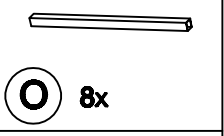
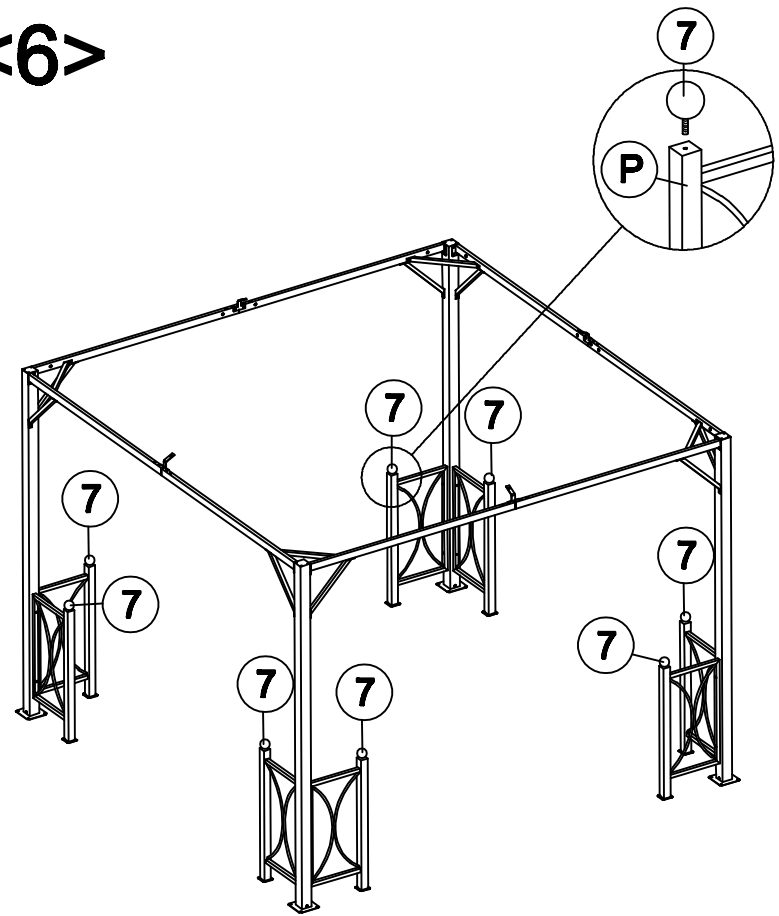

<7>

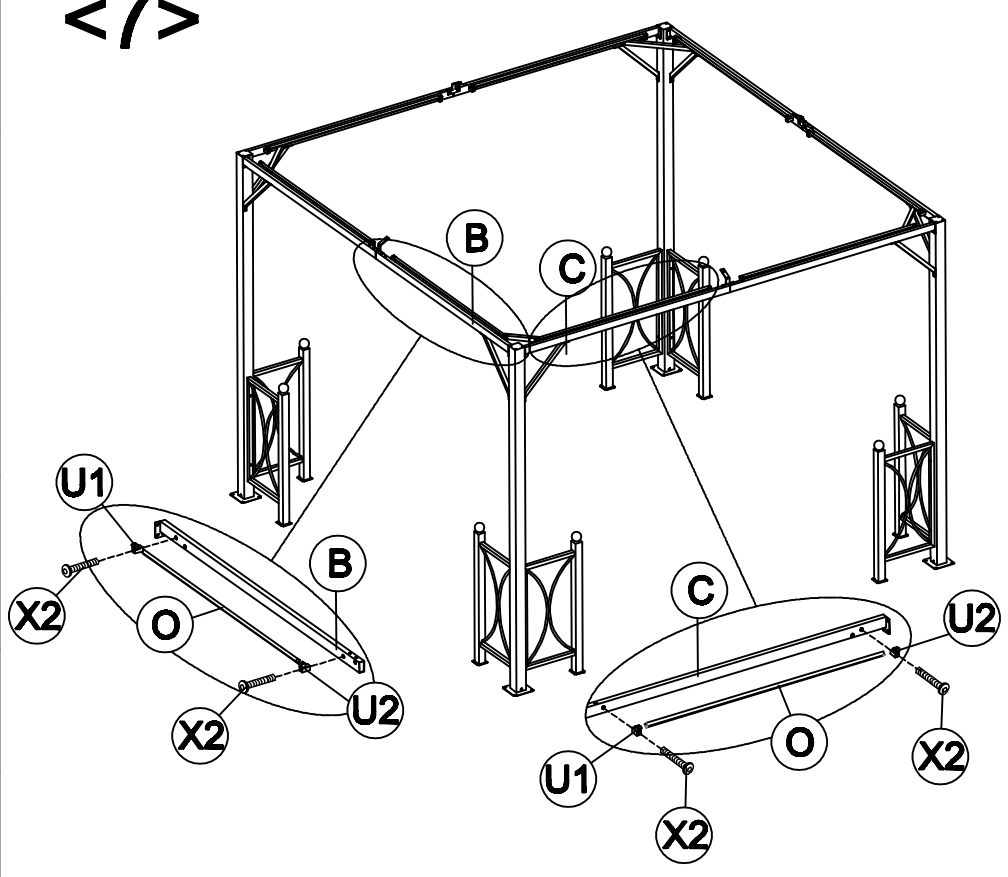
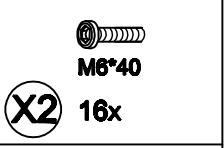
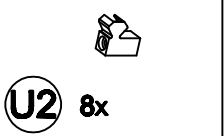
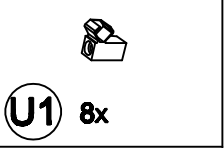

8



M 4x

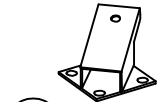

6 4x



13 1x



X1 12x
M6*15



20 12x

<8>

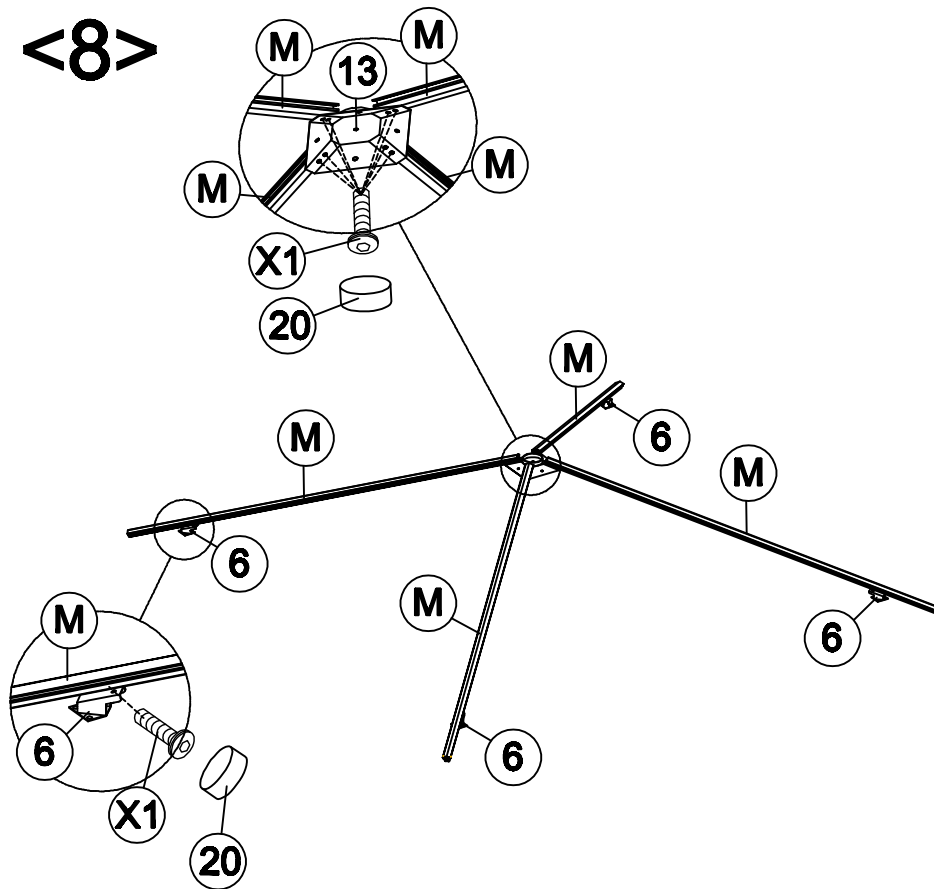

X1 12x
M6*15



20 12x

<9>

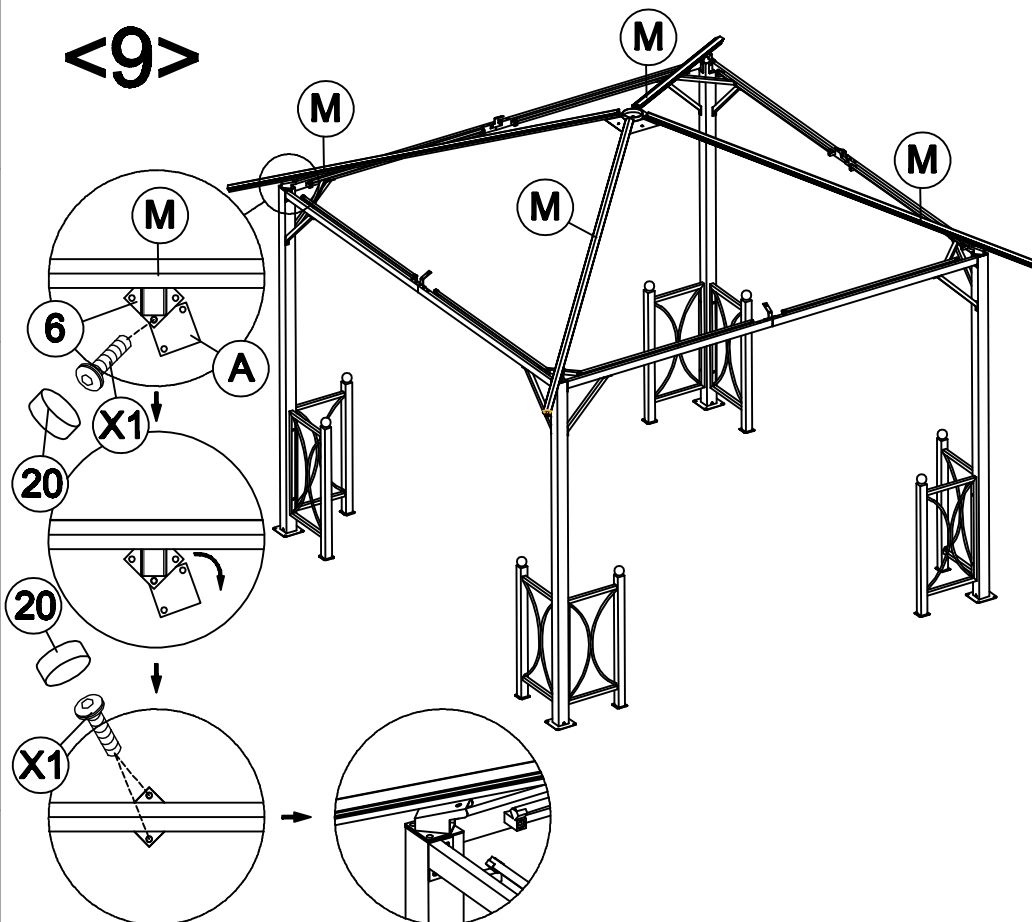

9



L 4x



M6*15

X1 8x



20 8x

<10>

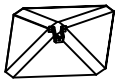
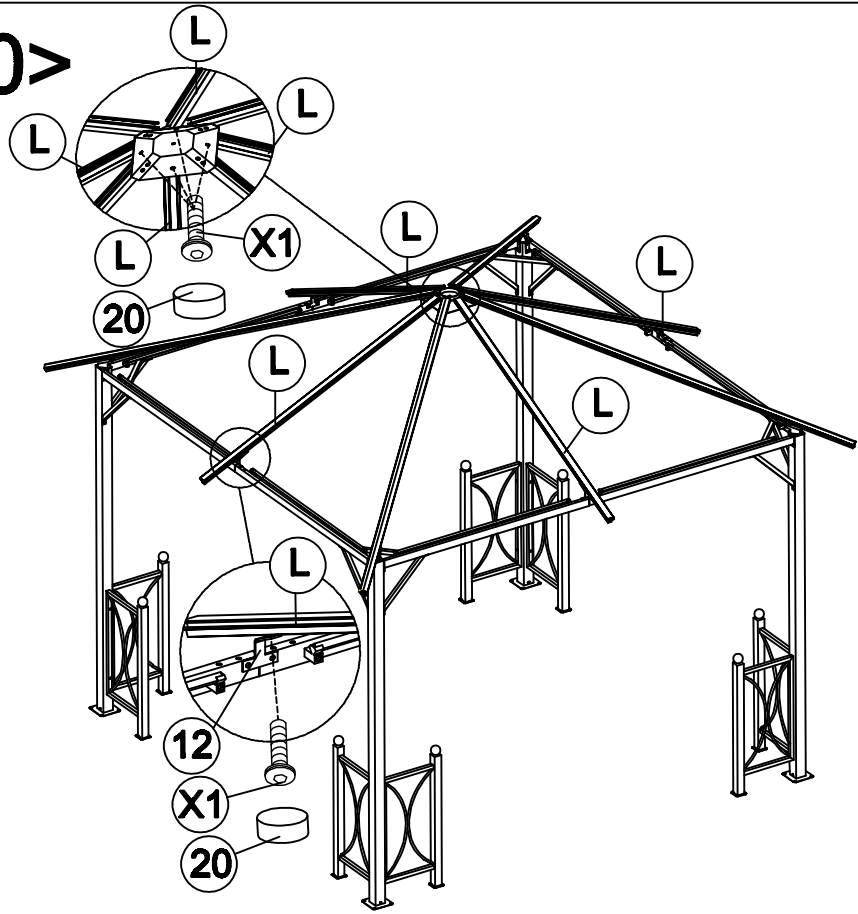

14 1x







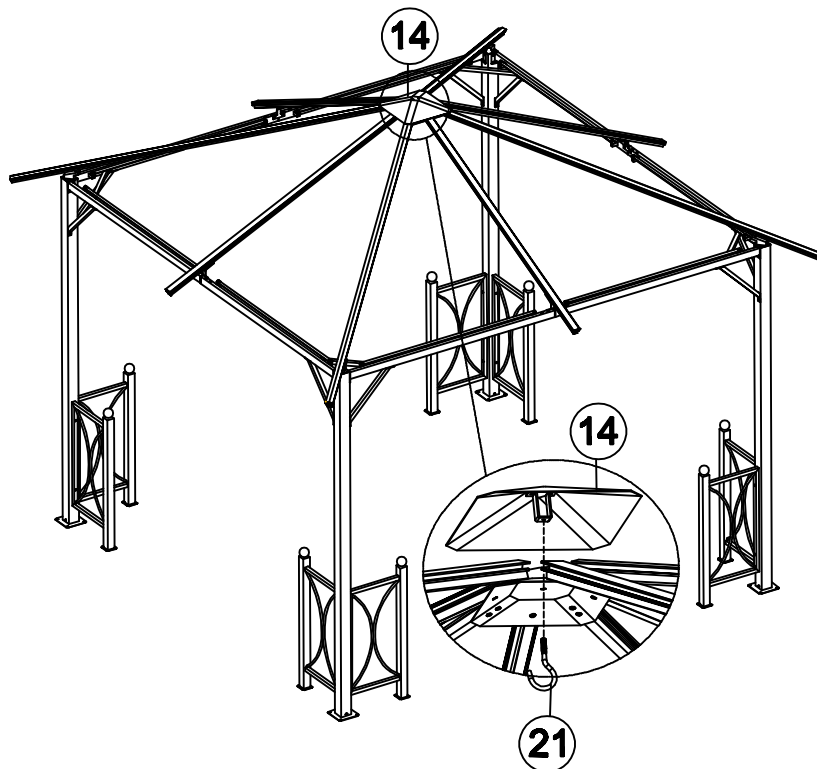

21 1x

<11>

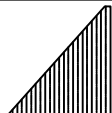
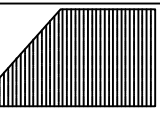
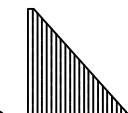
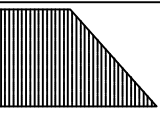

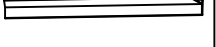

10

<12>

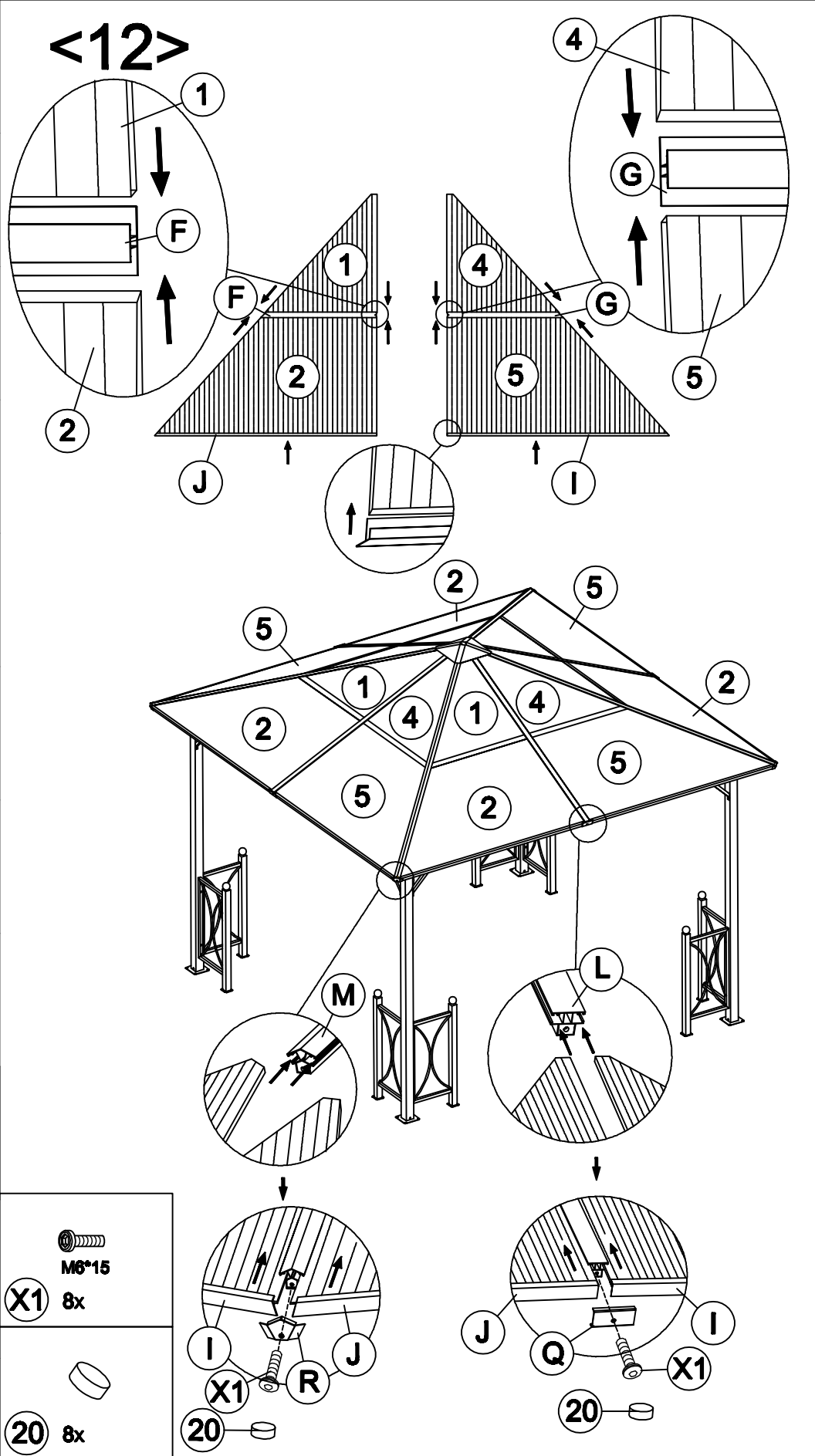
-  **1** 4x
-  **2** 4x
-  **4** 4x
-  **5** 4x
-  **F** 4x
-  **G** 4x
-  **I** 4x
-  **J** 4x
-  **Q** 4x
-  **R** 4x
- 11**



-  **M6*15**
- X1** 8x
-  **20** 8x

<13>



15 4x



16 4x



18 8x



21 4x

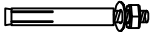

X4 12x

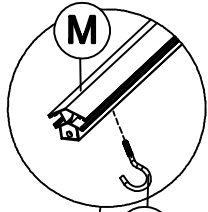
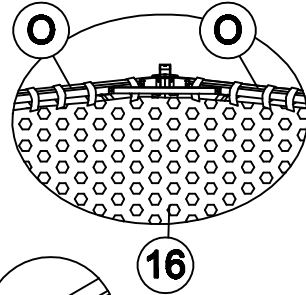
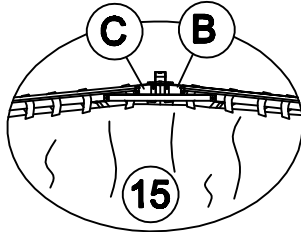

21

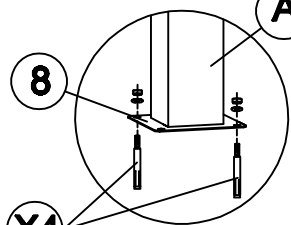
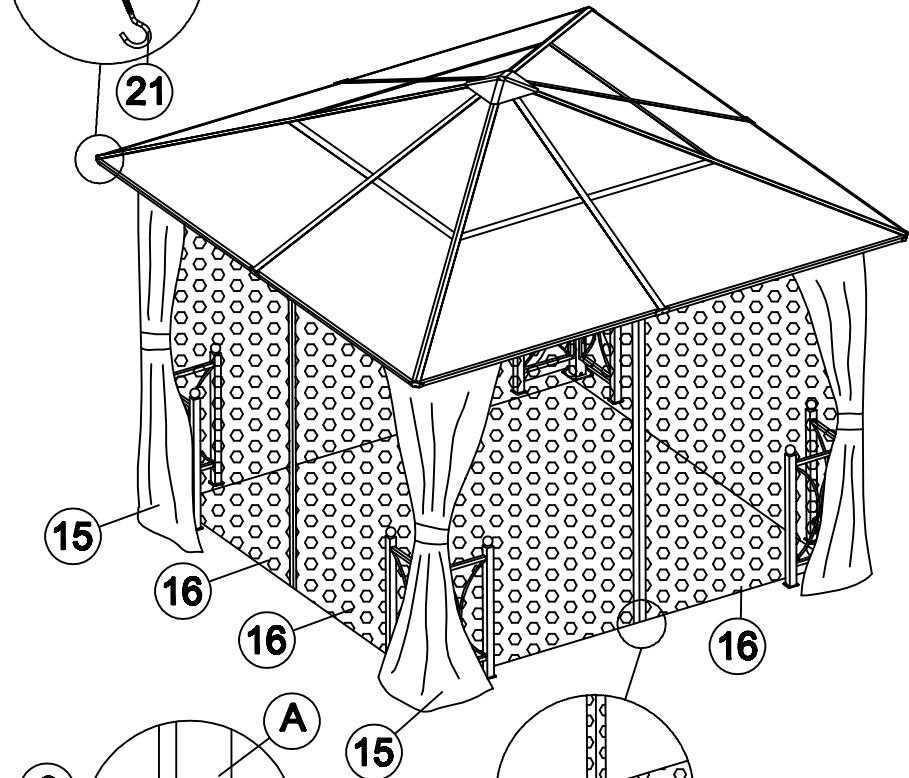
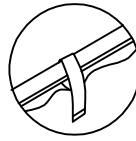



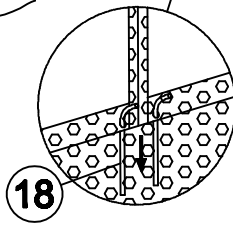



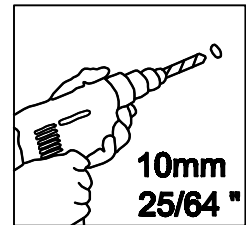



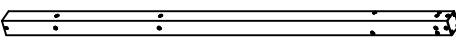

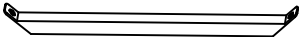



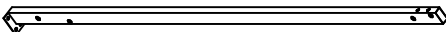
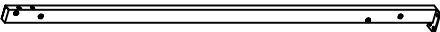

X4



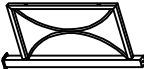







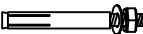

12



10mm
25/64"

Carton-1/3	No	Reference Picture	Part	Qty
	1		A	4
	2		L	4
	3		M	4
	4		N	12
	5		8	4
	6		10	4
	7		6	4
Carton-2/3	No	Reference Picture	Part	Qty
	1		B	4
	2		C	4
	3		F	4
	4		G	4
	5		I	4
	6		J	4
	7		O	8
	8		P	8
	9		Q	4
	10		R	4
	11		U1	8
	12		U2	8
13	13	 M6*15	X1	128
	14	 M6*40	X2	16

Carton-2/3	No	Reference Picture	Part	Qty
	15	 M6*30	X3	16
	16		X4	12
	17		7	8
	18		12	4
	19		13	1
	20		14	1
	21		15	4
	22		16	4
	23		18	8
	24		20	144
	25		21	5
	26	 S4		1

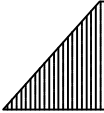
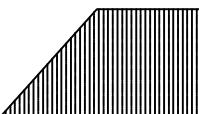
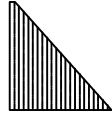
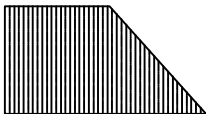
Carton-3/3	No	Reference Picture	Part	Qty
	1		1	4
	2		2	4
	3		4	4
	4		5	4