

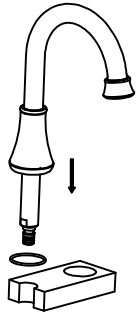

3 Hole Bathroom Faucet

<p>1</p> <p>Slide the washer(O-ring) to faucet base. Insert the new faucet through the sink.</p> 	<p>2</p> <p>Prepare to install the underneath receiver. Install washer on nut and tee joint.</p> 	<p>3</p> <p>Insert rubber washer, then insert trident joint. Tighten trident and align with valve.</p> 	<p>4</p> <p>Tighten coupling nut and insert trident.</p> 	<p>5</p> <p>Insert hot and cold water handles through the hole.</p> 	<p>6</p> <p>Put on fitting accessories in correct order.</p> 
--	--	--	--	---	--

<p>7</p> <p>Tighten the handles.</p> 	<p>8</p> <p>Connect and tighten the hoses with hot and cold Water supplies. Turn on Water supplies, turn the handle, flush the hot and cold water for 1 minute.</p> 	<p>9</p> <p>Connect and tighten the hoses</p> 	<p>Inspection installation results:</p> <ol style="list-style-type: none"> 1. Check to make sure that all of the connection has been tightened. Make sure the handle in the closed position. 2. Open the drainage system and the main Water supply, check and repair the the leaking interface. <p>Washing instructions</p> <p>Apply to all the processed surface processing:</p> <p>With neutral soap water to clean the plating surface. then use a clean soft cloth to wipe the surface with many cleaner. Lavatory spirit, etc. such as ammonia. household cleanser. and will cause ham to the plating surface, avoid by all means use.</p> <p>Wear and tear clean utensils or cleaner do not use on the faucet and its accessories.</p>
--	---	---	--

Note: Style may vary by model

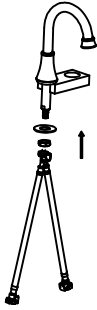
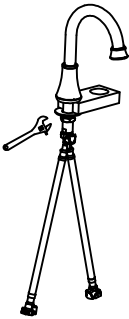
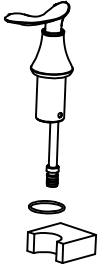
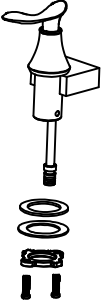
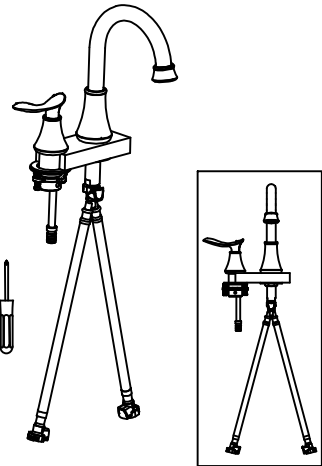
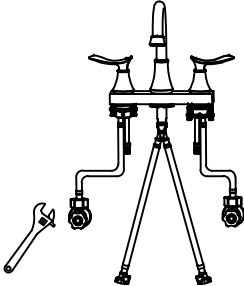
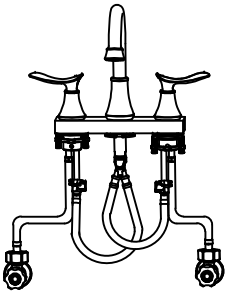
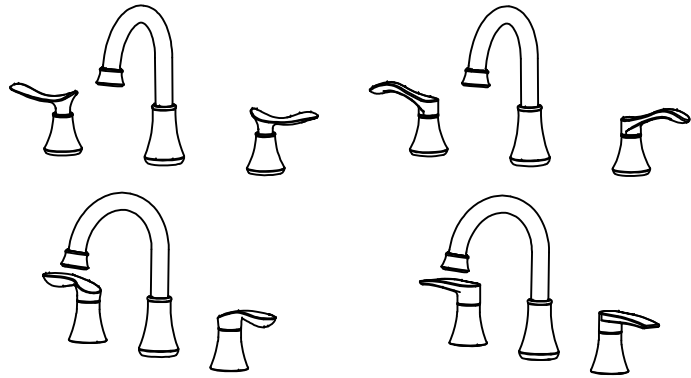
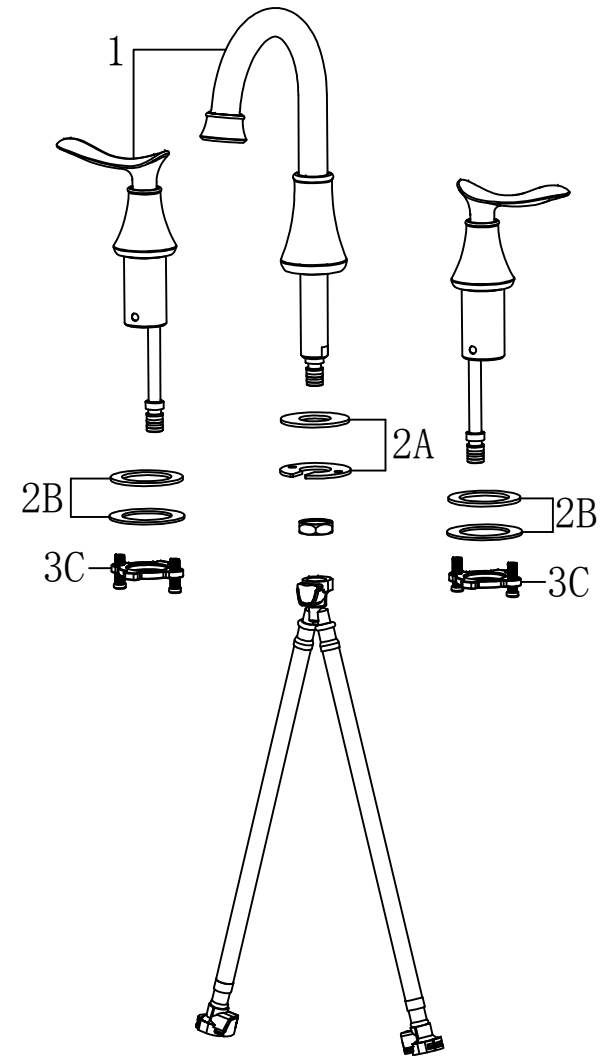



Diagram and Parts List

Note: Style may vary by model.



Before Installation

- A . Make sure you have all necessary parts by checking the diagram and parts list.
- B . Turn off the hot and cold water supply at the angle stops and turn on the old faucet to release any built up pressure. Remove existing faucet. Clean sink or countertop in preparation for new faucet.
- C . Shut off angle stops.
- D . Pre-drilled size requirement: 1-3/8" (min) - 1-1/2" (max)
 Max countertop thickness without deck plate: 1-1/2" (1 hole install)
 Max countertop thickness with deck plate: 1" (1, 2 or 3 hole install)

1/16" (1mm) min		1/16" (1mm) min	
1-1/2" (38mm) max		1" (25.4mm) max	
Ø 1-3/8" (35mm) min		Ø 1-3/8" (35mm) min	
Ø 1-1/2" (38mm) max		Ø 1-1/2" (38mm) max	

Tools you will need:



Adjustable Wrench



Safety Goggles



Silicone Sealant



Bucket



Phillips screwdriver

- 1. Faucet Body
- 2. Mounting Hardware
 - A. Rubber Washer
 - B. Rubber Washer
 - C. Iron Mounting Nut
- 3. Hot & Cold Waterlines