

Full Length Mirror

Instruction Manual

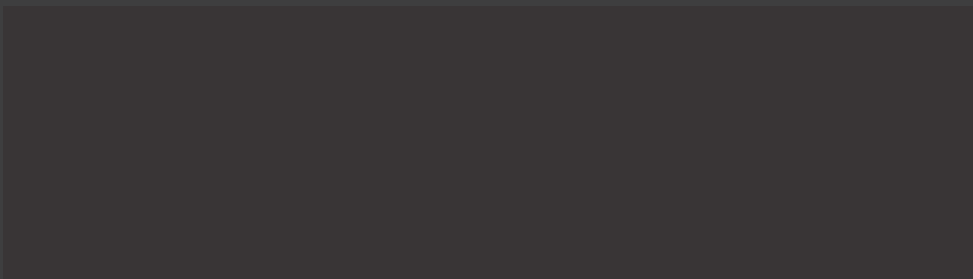
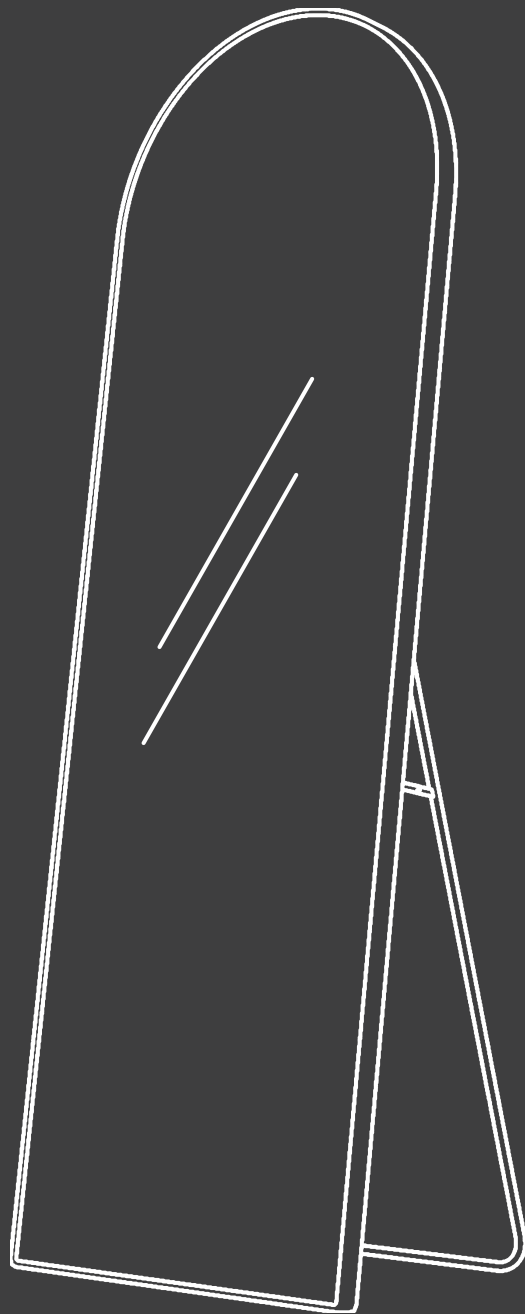

1 Before Assembly

Assembly Tips

- Check the list of contents before assembly to ensure that all parts are included in the package.
- Make sure the wall can bear the weight of the mirror.
- Do not use string or chain to hang the products.

Care Advice

- Before using, clean with warm water and a soft, lint-free cloth.
- Check all the screws and bolts are tight every three months or as needed.
- Clean with an ammonia-free glass cleaner or detergent.
- Avoid spraying cleaners directly onto the mirror.

2 Package List

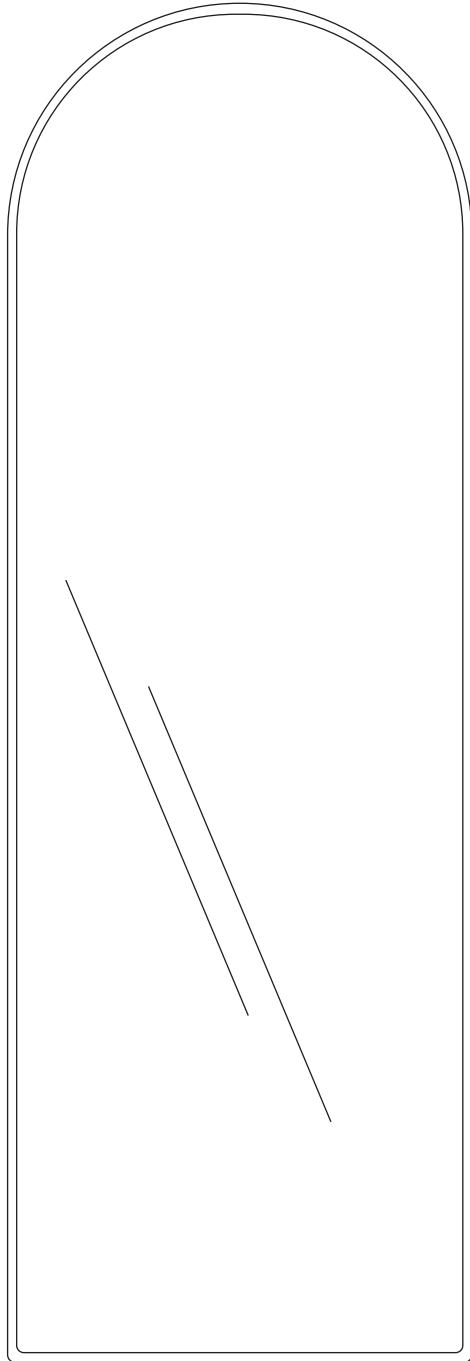

Mirror
x1

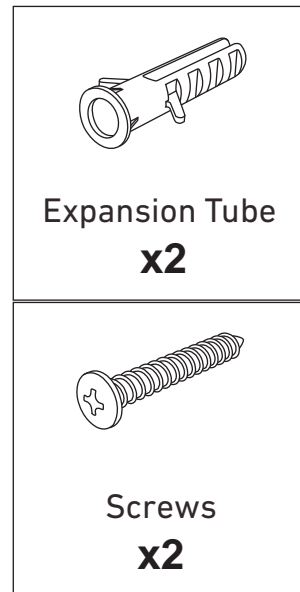

Tools Required (Not Provided)



3 Usage Method

Standing

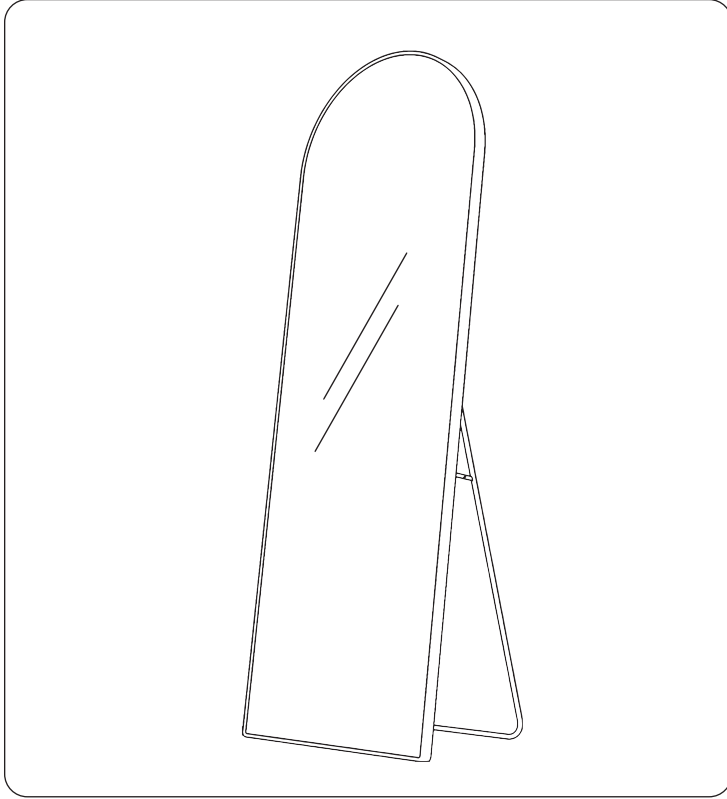

Leaning

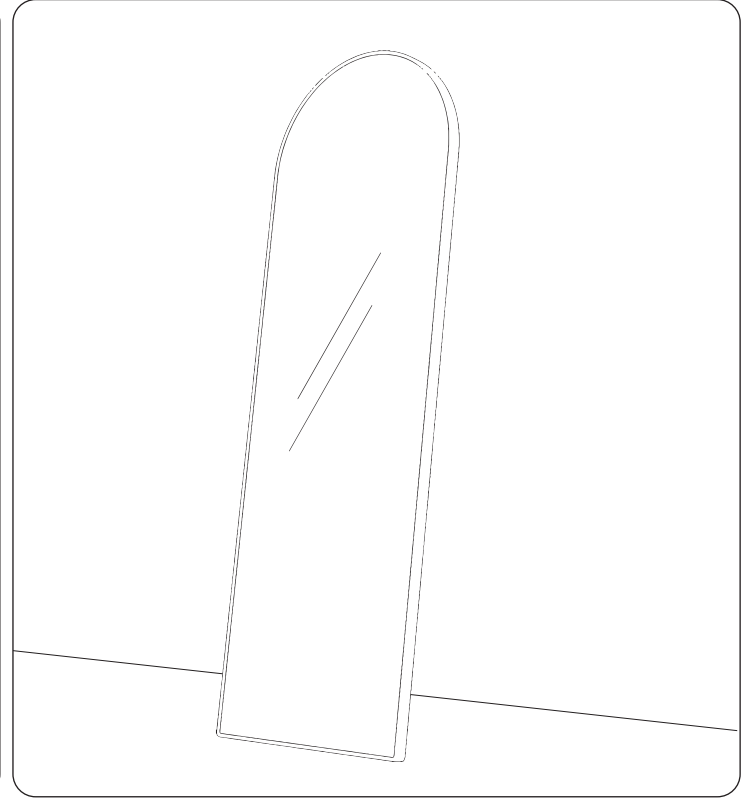

Hanging

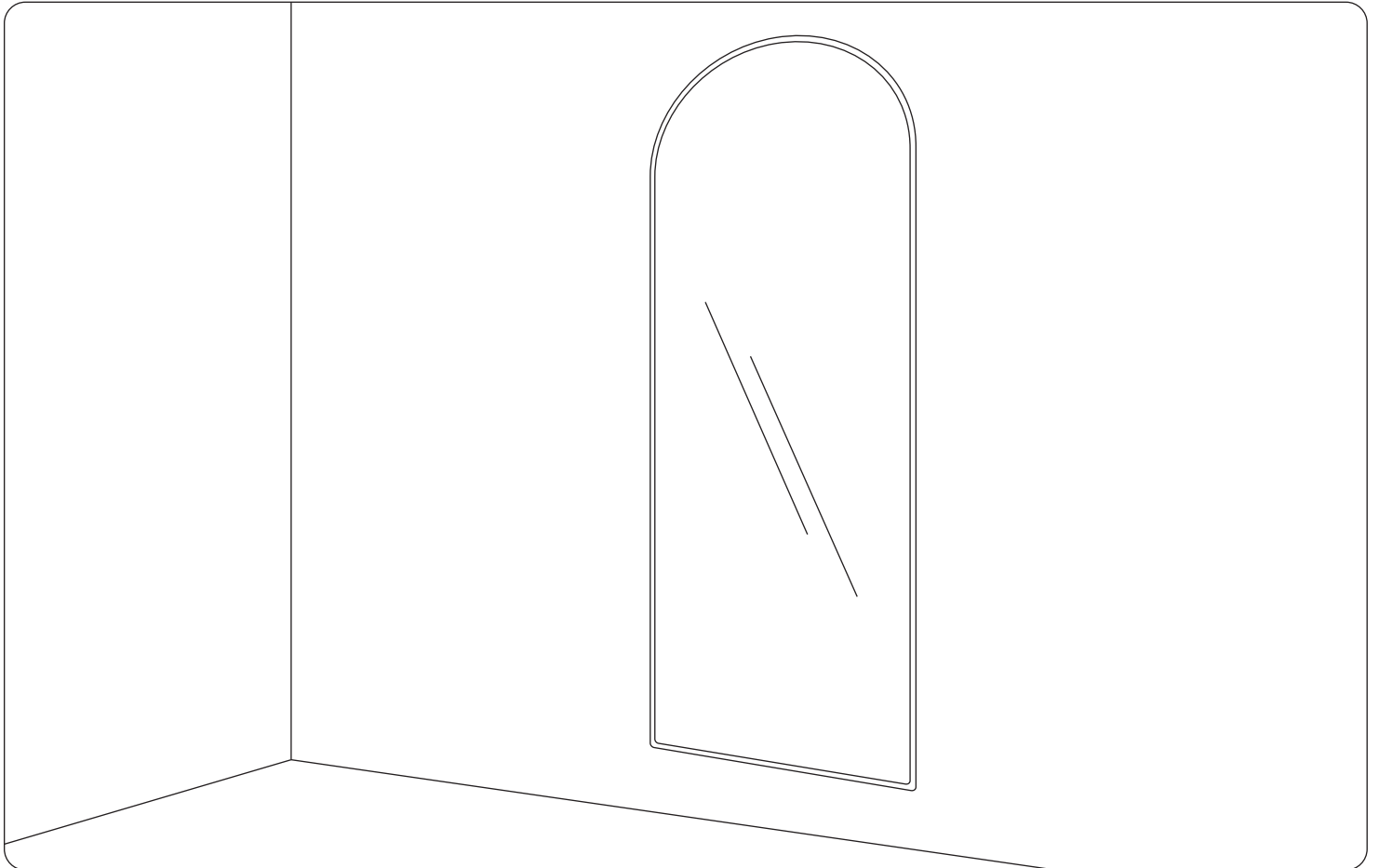

Step 1

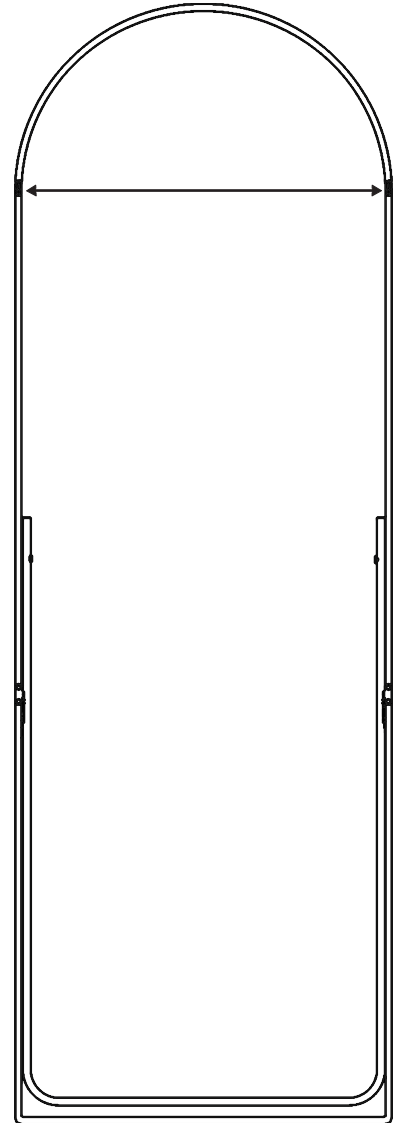
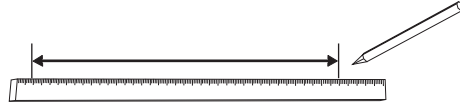

Use a ruler to accurately measure the distance between the mirror's two hooks, then measure and mark the same distance on the wall. Make sure they match perfectly.

Step 2

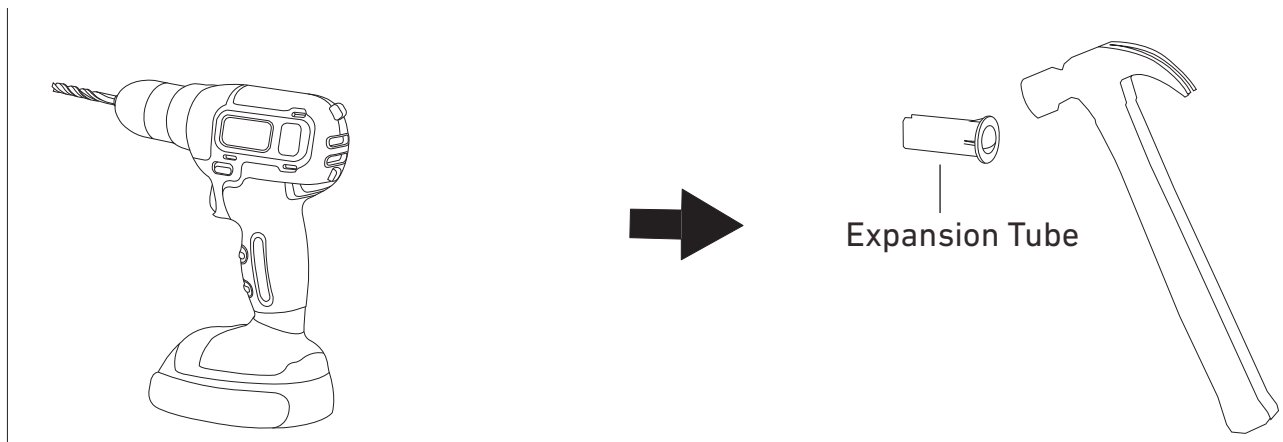

Drill holes at the marked positions on the wall. Hammer the Expansion Tube into the holes.

Step 3

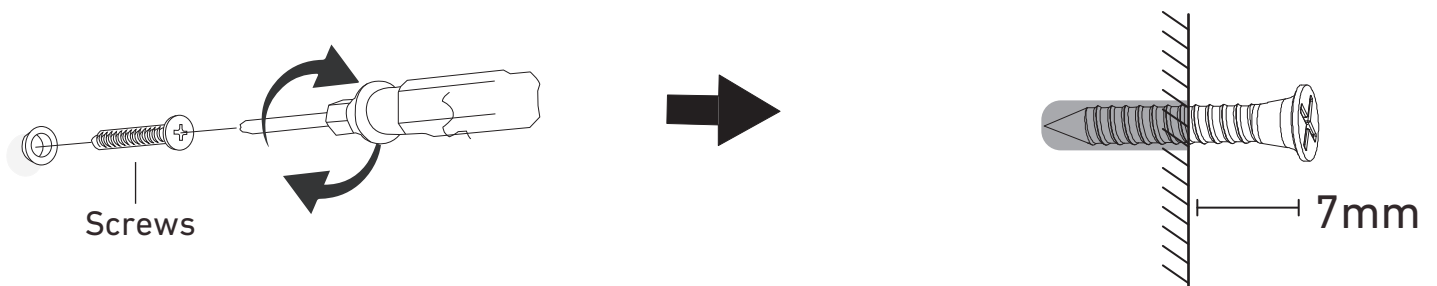

Fix the Screws into the Expansion Tube, leaving about **7mm** of the screws exposed.

Step 4



Hang the Mirror on the wall.

