

# Assembly Instructions

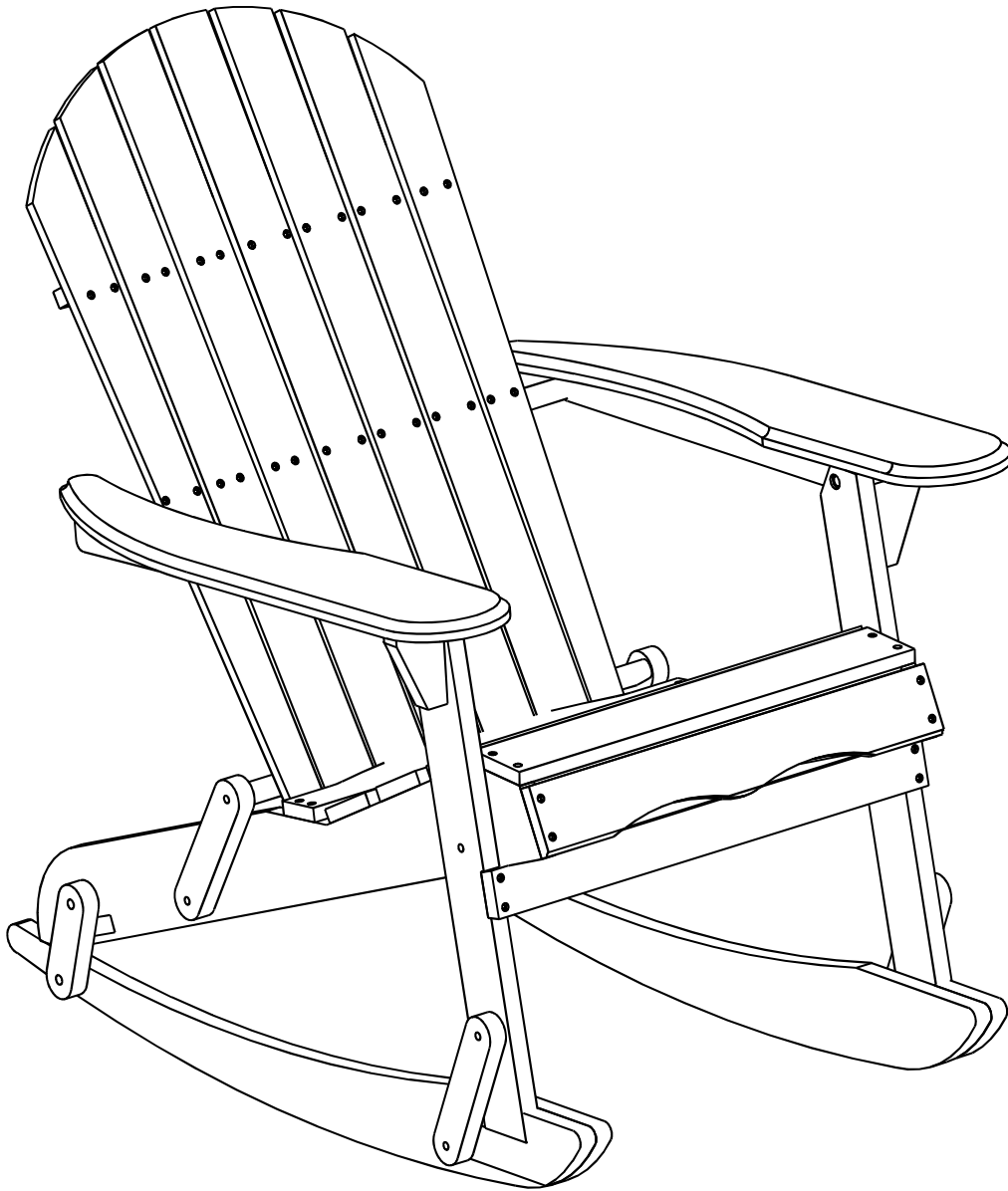

**Caution: You must read this before you proceed**

## **ROCKING ADIRONDACK**







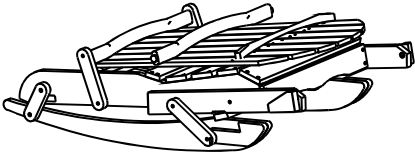

**CAUTION:** This Rocking Adirondack is NOT a TOY. Keep your child/ children at bay during the assemble process. For moving the Rocking Adirondack and to prevent damage to the Rocking Adirondack, two adults are needed to execute this action

## Parts List

Label	Picture	Description	QTY
A		Right Armrest	1
B		Left Armrest	1
C		Foldable Seat And Backrest	1



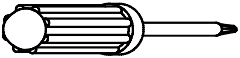

## Parts List

Label	Picture	Description	QTY
①		Bolt ( M8x35 mm )	3
②		Sleeve Nut ( M8x15mm)	3
③		Long Screw ( M7x70mm)	3
④		Screw ( M4x30mm) (Use with screwdriver)	5
⑤		Plastic Washer	3
⑥		Allen Key	2
⑦		Screwdriver (Not provided)	1

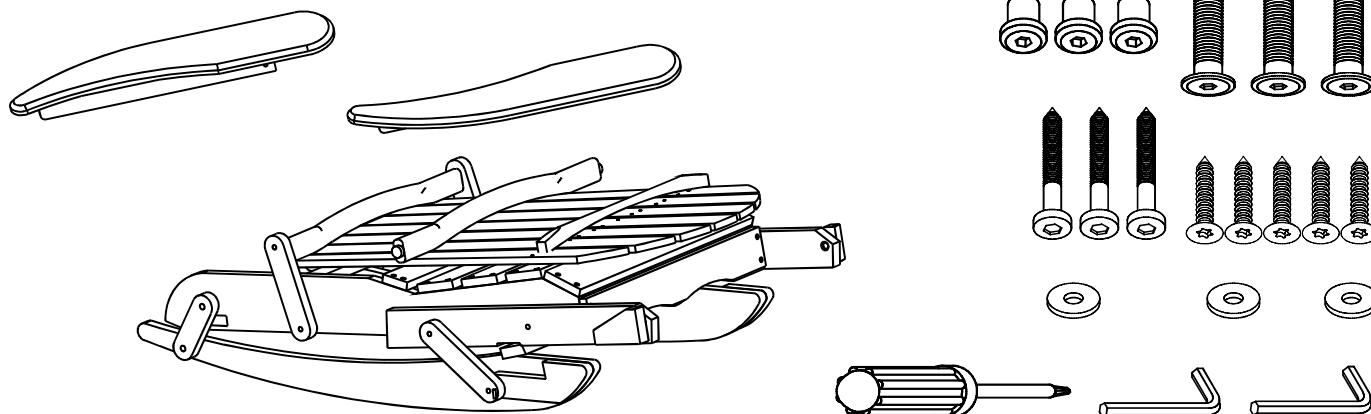
# Assembly Preparation

Before Beginning Assembly:



-  • Read instructions, cover to cover-
-  • Have 2 adults on hand for assembly-
-  • Do not assemble on flooring or carpet-
-  • Assemble on a clean non-marring surface (packing foam)-
-  • Save all packaging until finished-

## Assembly Steps

### OVERVIEW

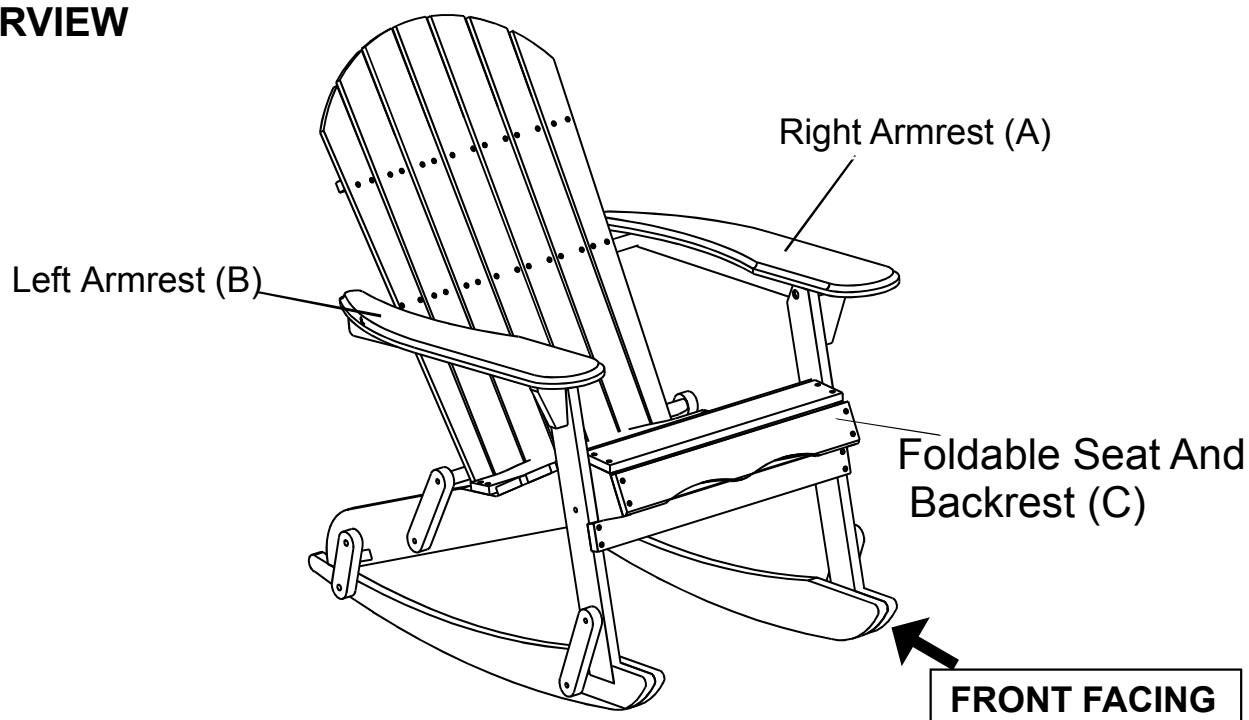

This Rocking Adirondack has multiple parts and may require up to 30 minutes to assemble. To give you an overview of the Rocking Adirondack parts, the above picture is to help you put the various parts into perspective. Please read through the instructions below to familiarise yourself with the parts and steps before assembly.

## Step 1

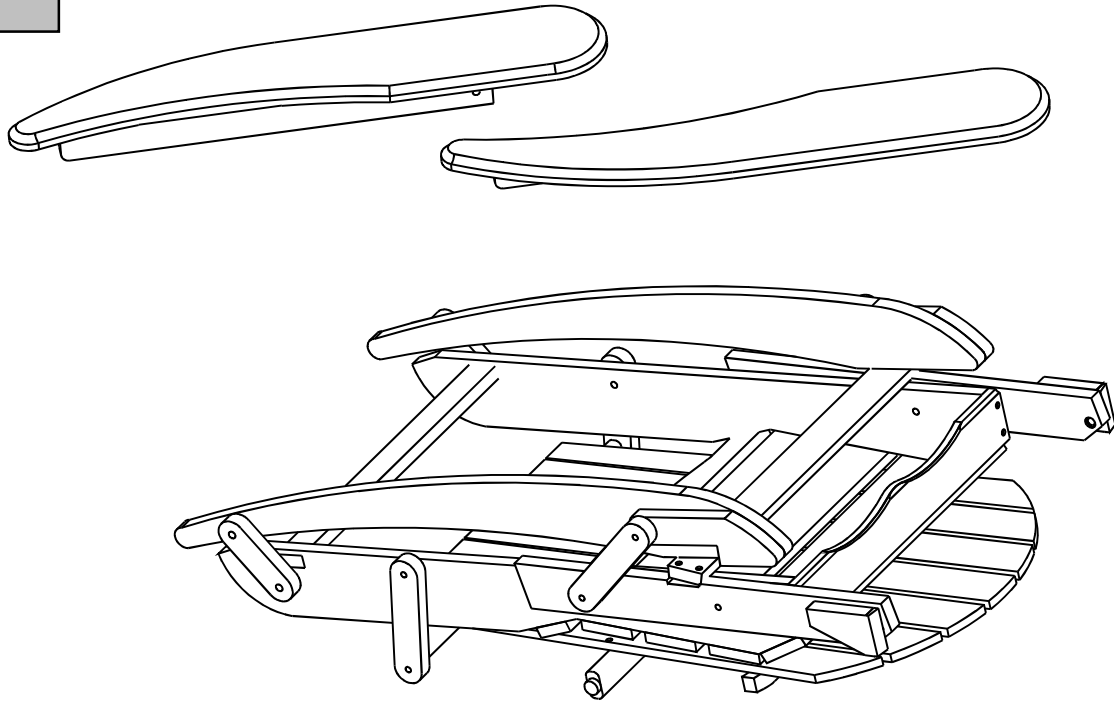

Unpack and place all parts on a clean, non-marring surface.

## Step 2

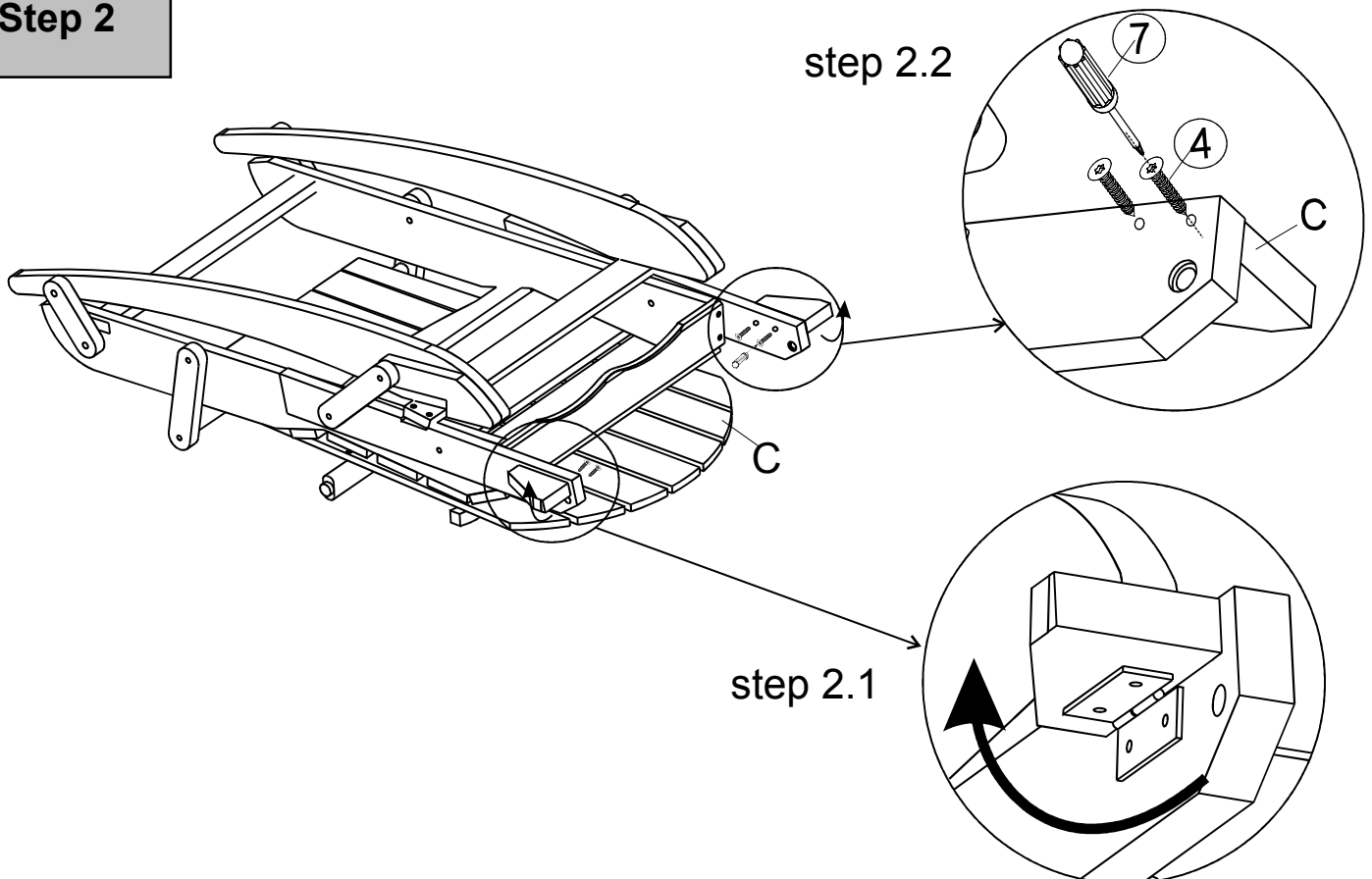

Step 2.1: Open Left and Right Support Corners as indicated with the arrow.  
Step 2.2: Using 2 Screw (④) and Screwdriver (⑦) attach Right Leg to Right Support Corner.

Repeat the same process with the Left Leg and Left Support Corner

### Step 3

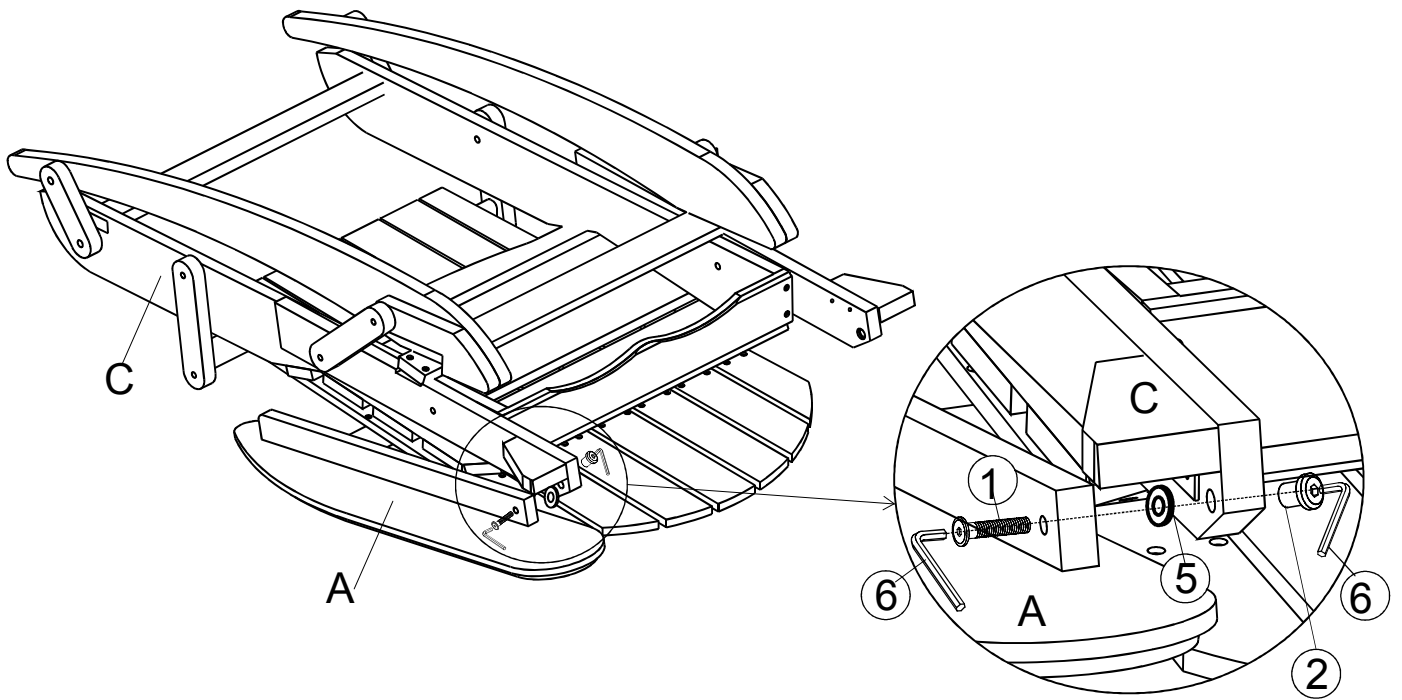

Attach Right Armrest (A) to Foldable Seat and Backrest ( C ) using Bolt (①), Sleeve Nut (②), Plastic Washer (⑤) and 2 Allen Key (⑥)

Repeat the same process with the Left Armrest (B).

**Do not fully tighten Bolts.**

**Note:** Plastic Washer (⑤ ) should be placed between Leg and Armrest.

### Step 4

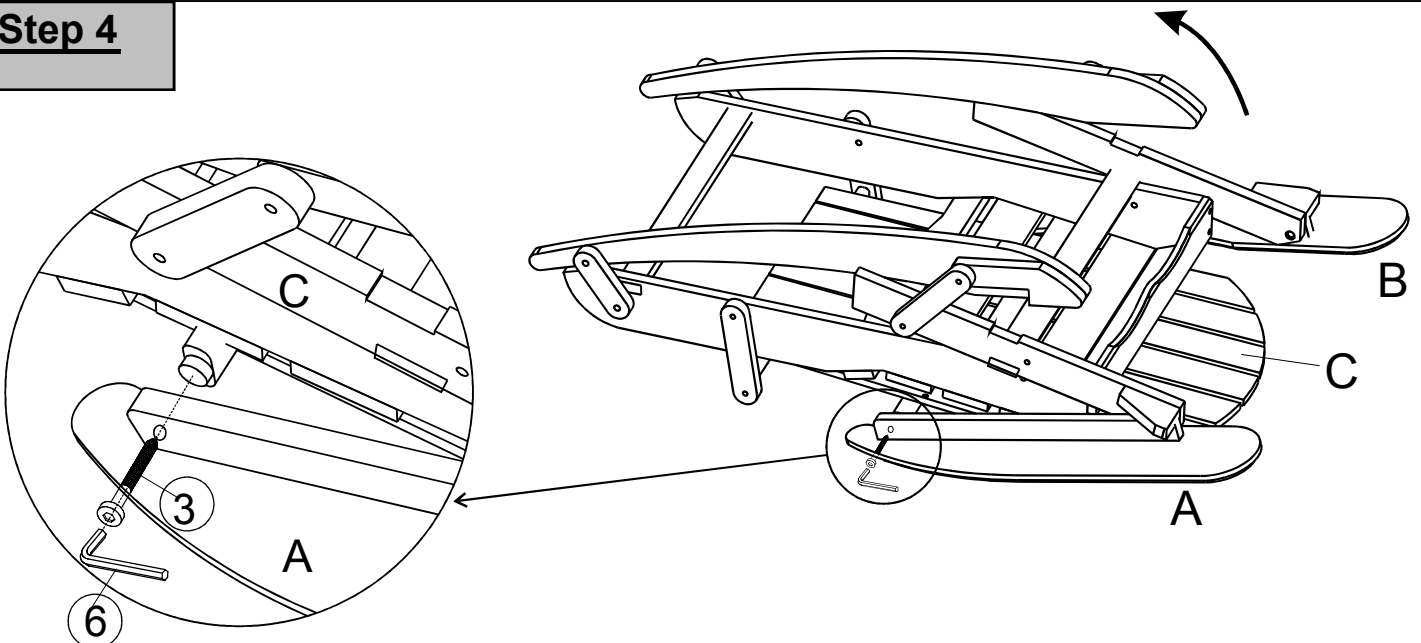

Open Seat and Backrest ( C ) as indicated with the arrow.

Put tenon of Backrest Support into the hole of Right Armrest (A) Secure Right Armrest (A) to Seat and Backrest (C) using Long Screw (③), Allen Key (⑥).

Repeat the same process with the Left Armrest (B).

## Step 5

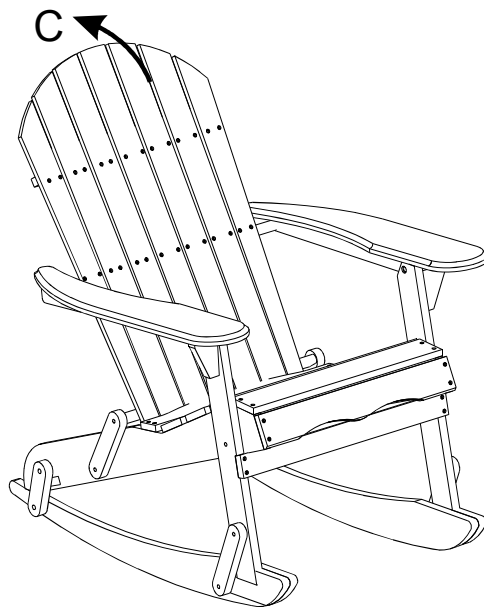

Turn over Rocking Adirondack and open Backrest as indicated with the arrow.

In a sequential manner, tighten all Bolts and Screws at all joints until fully locked into position

Your Rocking Adirondack is ready for use.

This Rocking Adirondack can only be used on a flat, level surface.

## Step 6

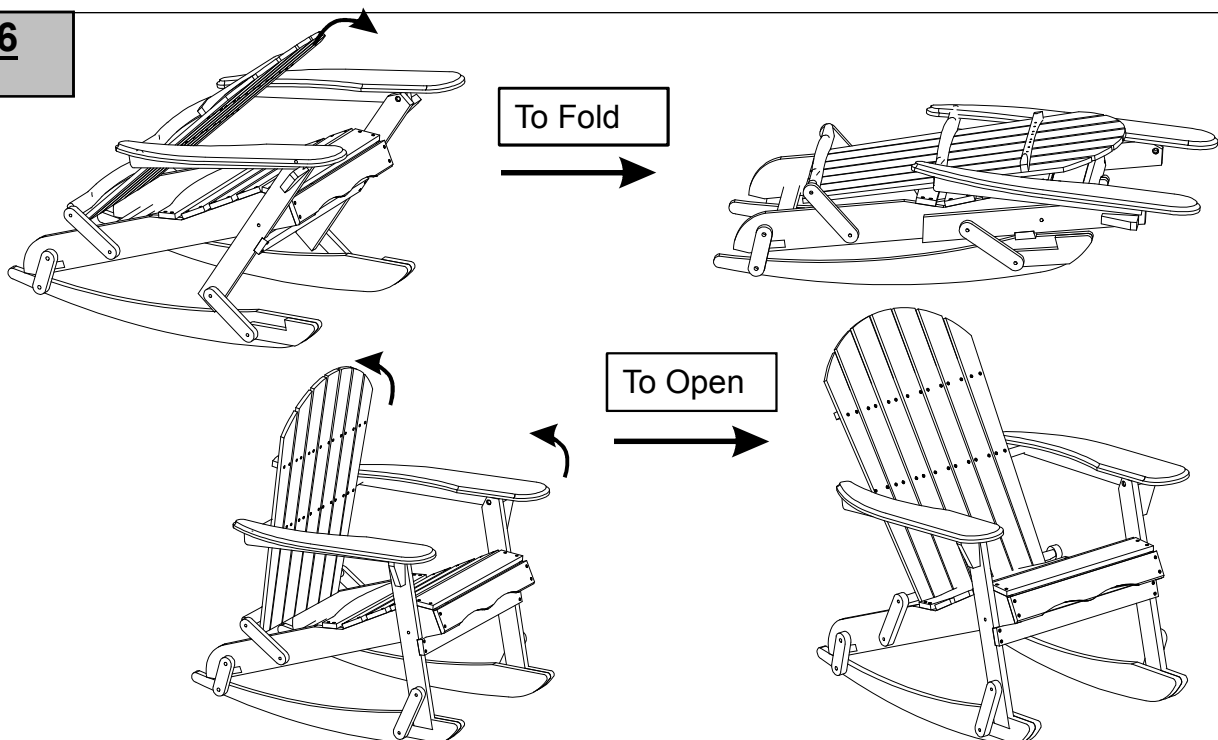



















This Rocking Adirondack can be folded shut.

To fold this Rocking Adirondack, raise up Backrest and fold Seat with Leg Frame as indicated by the arrows, by hand, until the Rocking Adirondack folds shut

To open this Rocking Adirondack, open Backrest and Seat as indicated by the arrows, by hand until the Adirondack folds out and locks into position.

Note: This Rocking Adirondack is slightly heavy, do exercise caution to avoid injury.

## Care & Maintenance

-   ● Do not put hot items directly on furniture surface.
  -   ● Do not clean furniture with harsh cleansers or polish.
  -   ● To obtain the longest lifespan of your outdoor products, minimizing exposure to direct sunlight is recommended.
  -   ● Children should not climb or jump on the furniture.
  -   ● Do not write on furniture without a padded barrier to protect the surface.
  -   ● To obtain the longest lifespan of your outdoor products, avoid extended and lengthy exposure to rain, snow, and direct sunshine. Whenever possible cover the product and /or place under patio or awnings.
  -   ● Not for commercial use. For residential use only.
  -   ● Stains may be removed with mild soap solution and damp cloth.
- 
-   ● Dust and pick-up spills using a clean, non-colored, lint-free cloth.

## Questions & Answers about Proposition 65

- What is Proposition 65?

Proposition 65 requires businesses to provide warnings to Californians about significant exposures to chemicals that cause cancer, birth defects or other reproductive harm. These chemicals can be in the products that Californians purchase, in their homes or workplaces, or that are released into the environment. By requiring that this information be provided, Proposition 65 enables Californians to make informed decisions about their exposures to these chemicals.

Proposition 65 also prohibits California businesses from knowingly discharging significant amounts of listed chemicals into sources of drinking water.

Proposition 65 requires California to publish a list of chemicals known to cause cancer, birth defects or other reproductive harm. This list, which must be updated at least once a year, has grown to include approximately 900 chemicals since it was first published in 1987.

- What types of chemicals are on the Proposition 65 list?

The list contains a wide range of naturally occurring and synthetic chemicals that include additives or ingredients in pesticides, common household products, food, drugs, dyes, or solvents. Listed chemicals may also be used in manufacturing and construction, or they may be byproducts of chemical processes, such as motor vehicle exhaust.

- What does a warning mean?

If a warning is placed on a product label or posted or distributed at a workplace, a business, or in rental housing, the business issuing the warning is aware or believes that it is exposing individuals to one or more listed chemicals.

By law, a warning must be given for listed chemicals unless the exposure is low enough to pose no significant risk of cancer or is significantly below levels observed to cause birth defects or other reproductive harm.

- Where can I get more information on Proposition 65?

If you have specific questions on the administration or implementation of Proposition 65, you can contact OEHHA's Proposition 65 program at [P65.Questions@oehha.ca.gov](mailto:P65.Questions@oehha.ca.gov), or by phone at (916) 445-6900.