

# ASSEMBLY INSTRUCTIONS

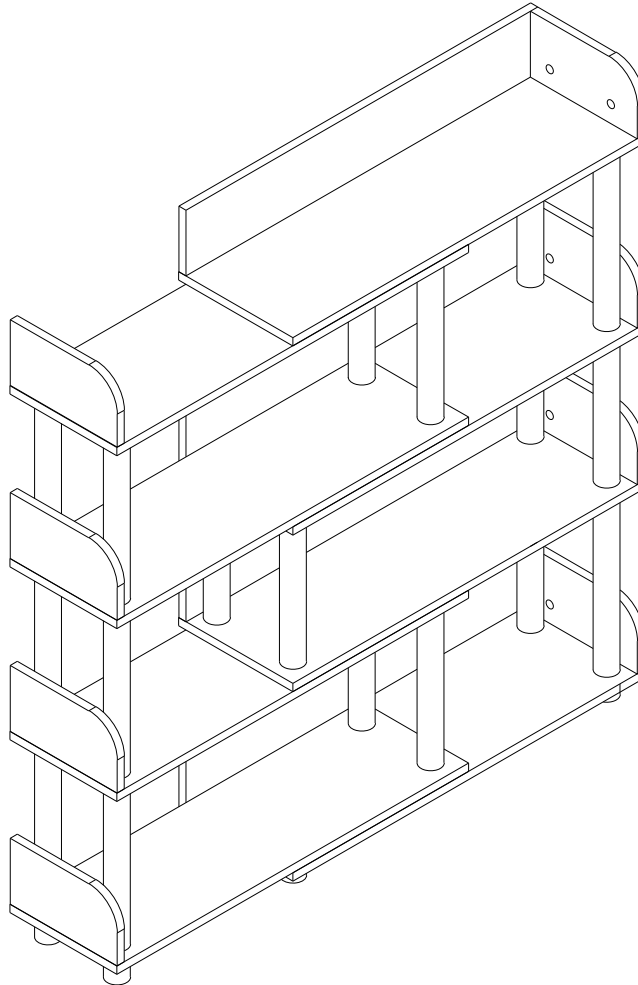

## Notice:

1. Follow the installation instructions. Please confirm all accessories are preset before installation.
2. Do not fully tighten the screws during initial assembly. Fully tighten screws only once all pieces which are correctly assembled.
3. If you encounter any problems during installation, please contact our customer service.
4. Please unbox the item from the side with an open-label and put a carpet on the floor to avoid scratching it.

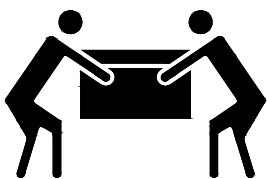

Recommended installers:2

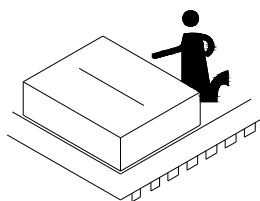



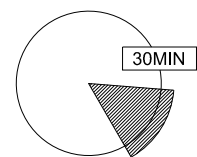

Put a carpet on the floor  
before unpacking



Estimate installation time:  
30minutes

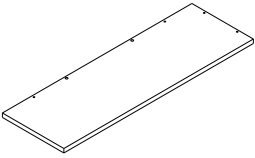
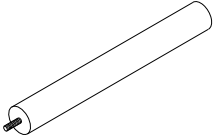
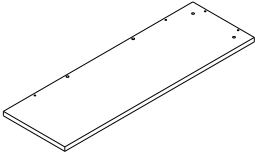
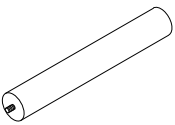
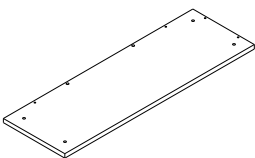

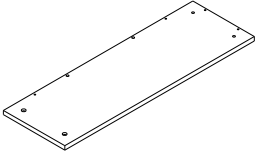
# ASSEMBLY INSTRUCTIONS

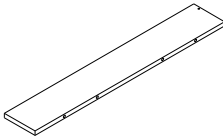
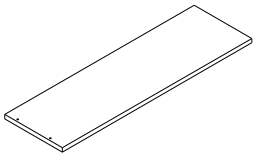
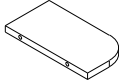
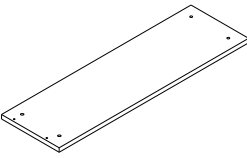
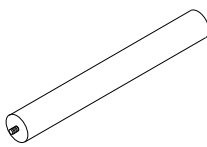
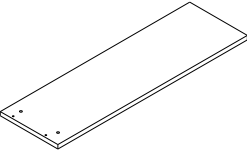
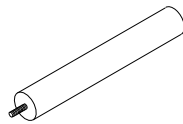
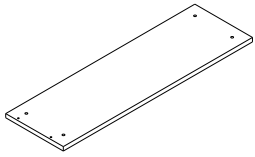
## PART LIST





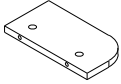
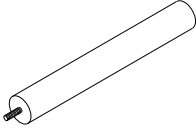
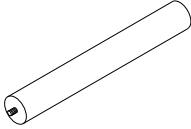

Item no.	Reference Image	Qty	Item no.	Reference Image	Qty
(A)		X1	(I)		X2
(B)		X1	(J)		X2
(C)		X1	(K)		X2
(D)		X1	(L)		X2
(E)		X4	(M)		X1
(F)		X4	(N)		X1
(G)		X2	(O)		X1
(H)		X2	(P)		X1

# ASSEMBLY INSTRUCTIONS

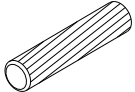
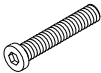
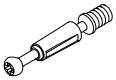
## PART LIST

Item no.	Reference Image	Qty	Item no.	Reference Image	Qty
Q		X4	S		X4
R		X6	T		X2

## HARDWARE LIST

Item no.	Reference Image	Qty	Item no.	Reference Image	Qty
1	 Ø8*30mm	X8	5	 Ø1/4*2-1/4"	X4
2		X24+2	6		X1
3		X24+2	7		X2
4	 Ø1/4*1-1/4"	X8	8	 Ø7*Ø4*24mm	X4

# ASSEMBLY INSTRUCTIONS

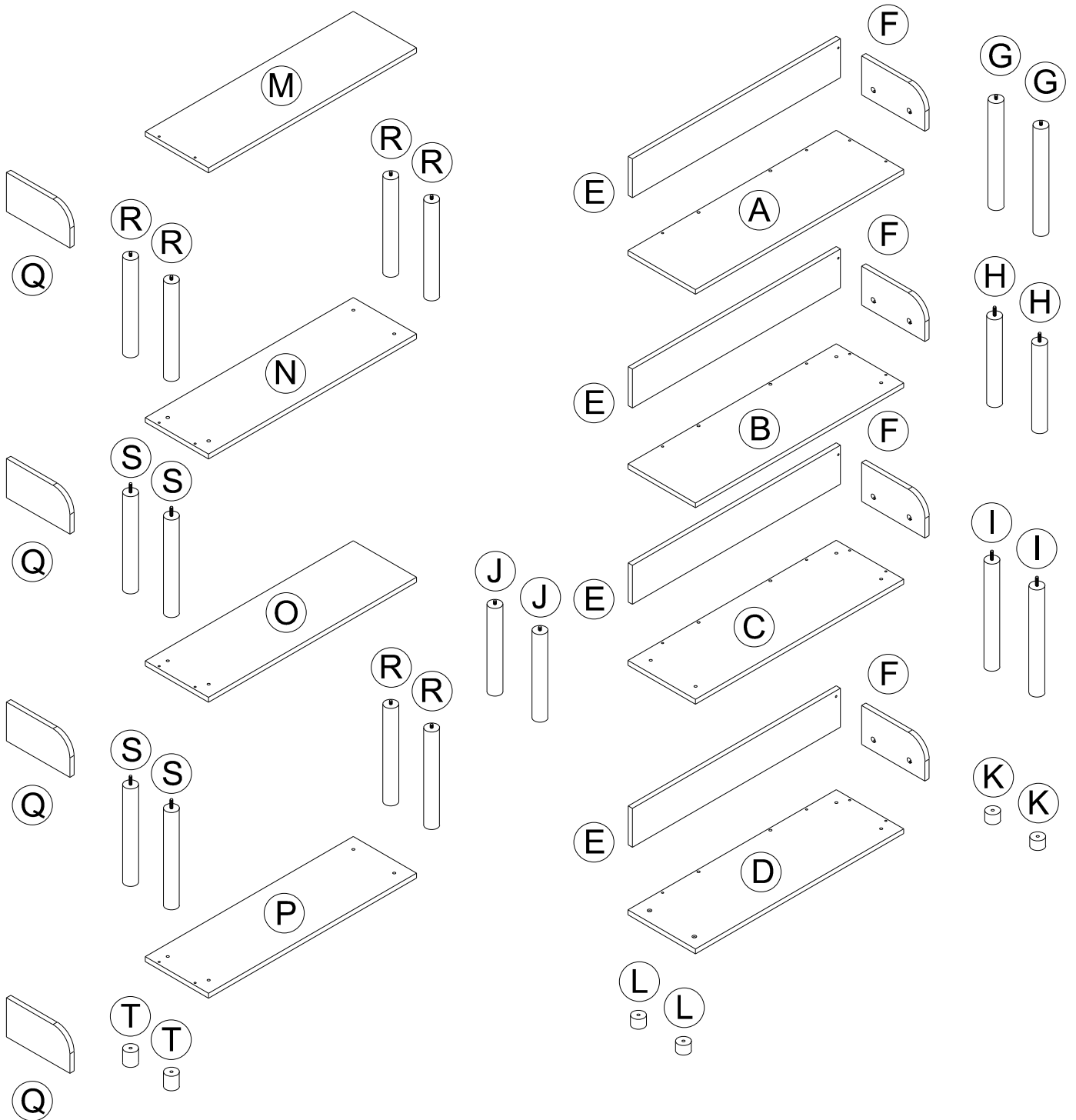

# ASSEMBLY INSTRUCTIONS

1

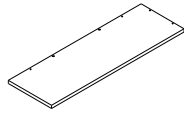

(A) 1pc

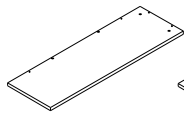

(B) 1pc

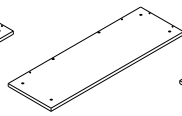

(C) 1pc

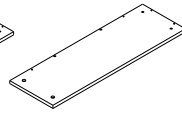

(D) 1pc

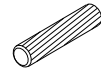

(1) 8pcs

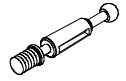

(2) 16pcs

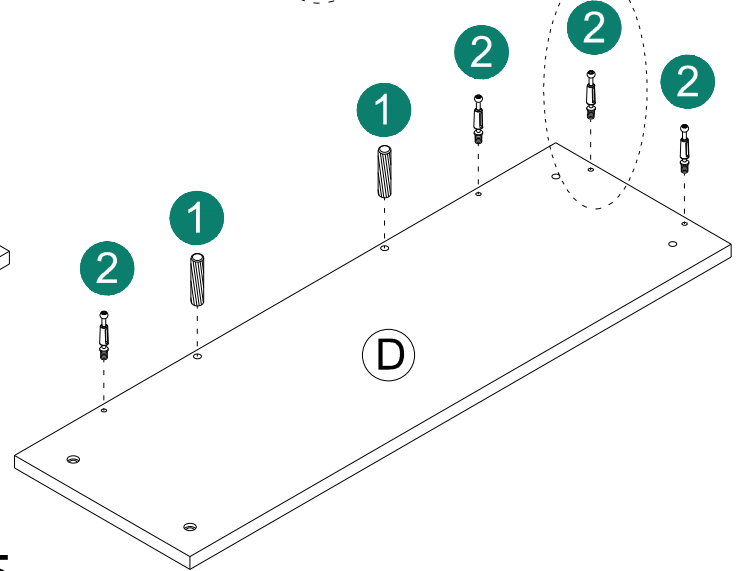
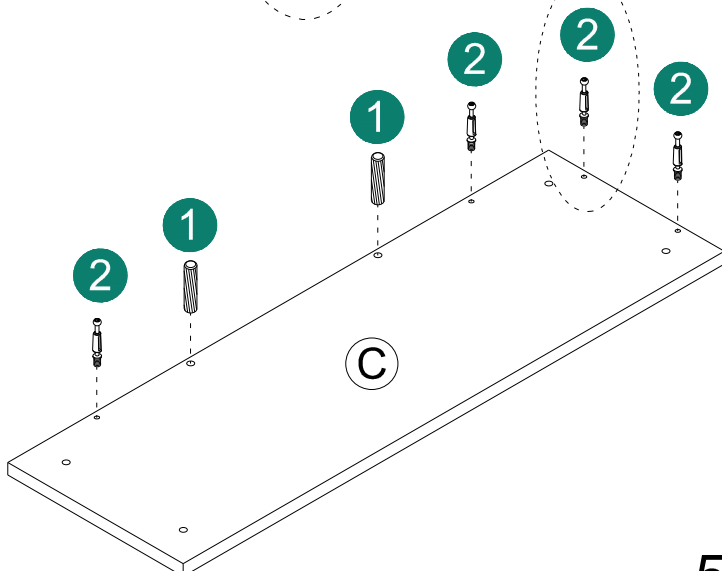
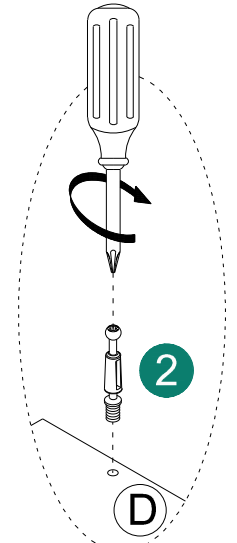
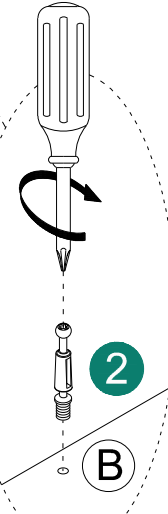
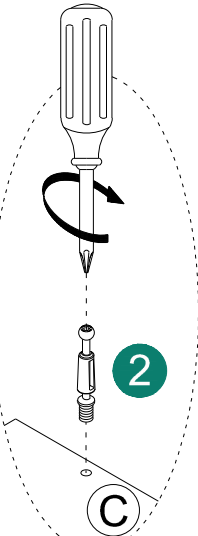
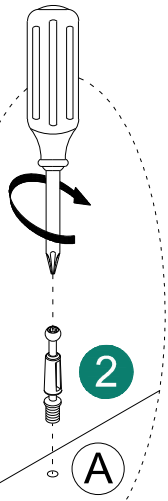
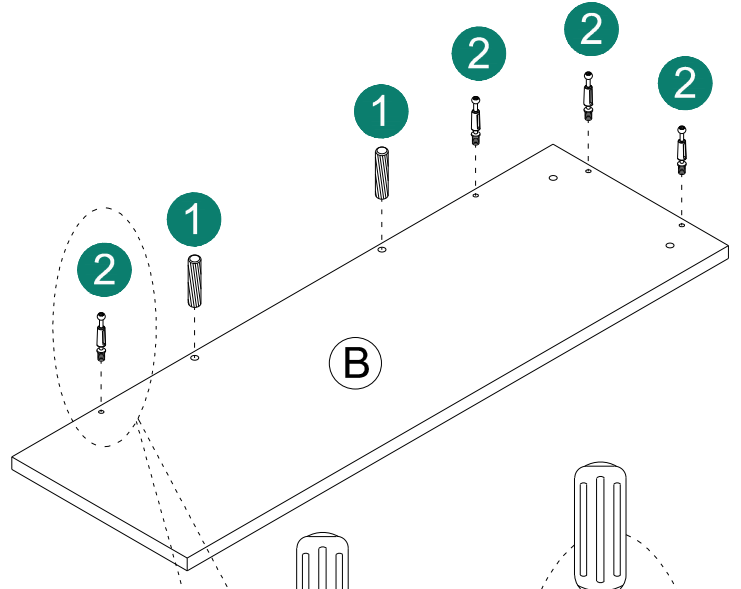
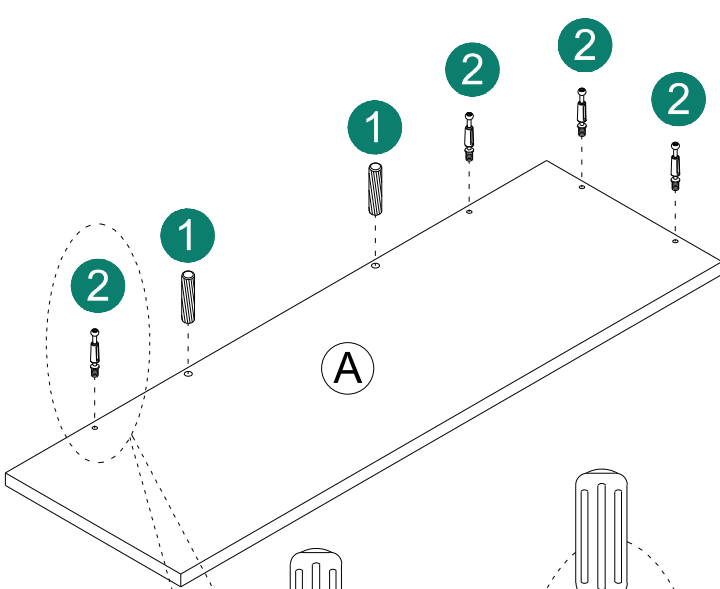

# ASSEMBLY INSTRUCTIONS

2

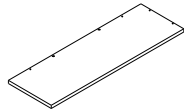

A 1pc

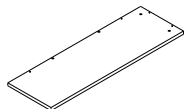

B 1pc

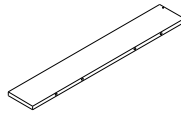

E 2pc

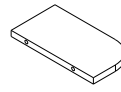

F 2pc



3 8pcs

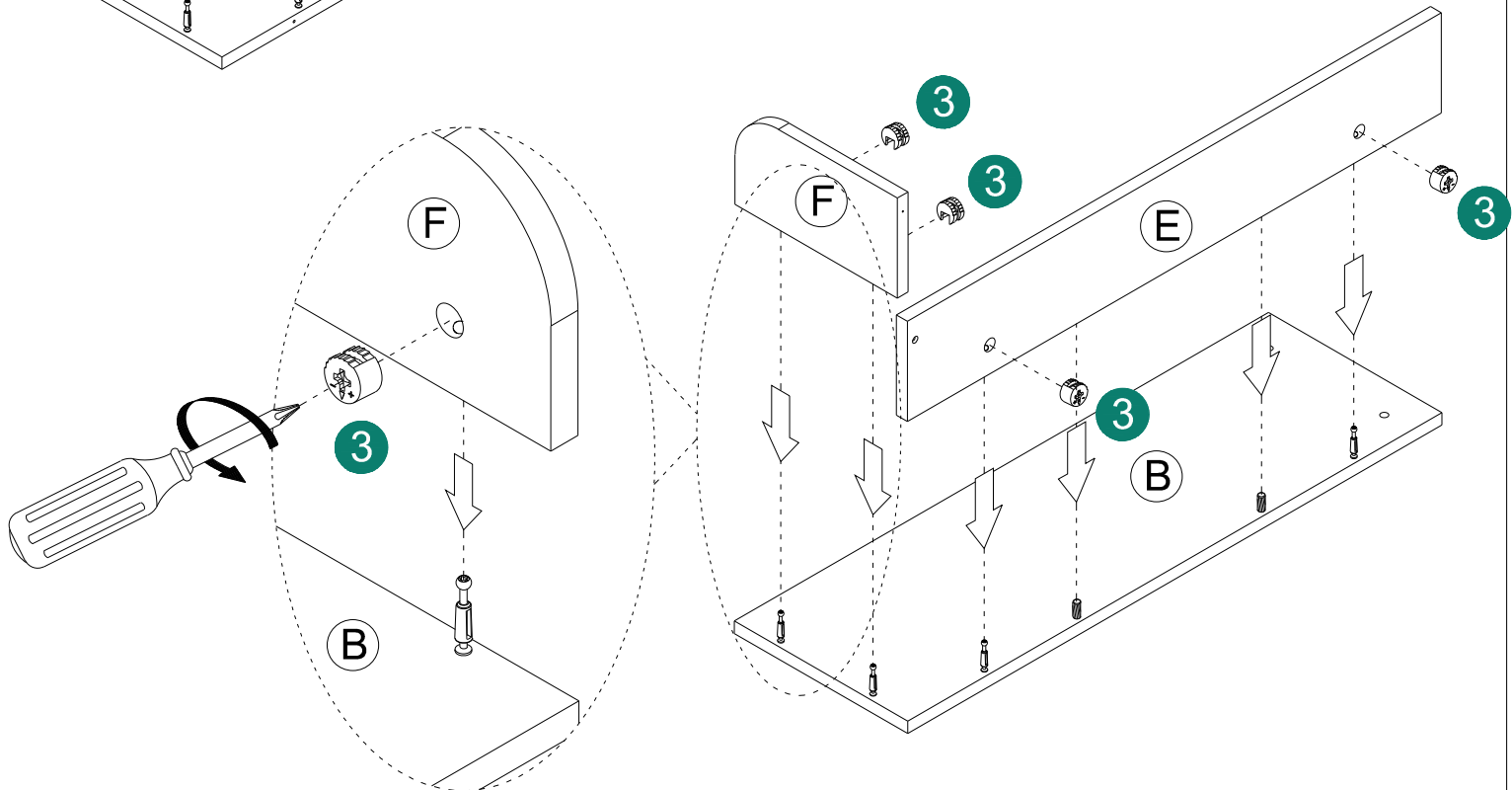
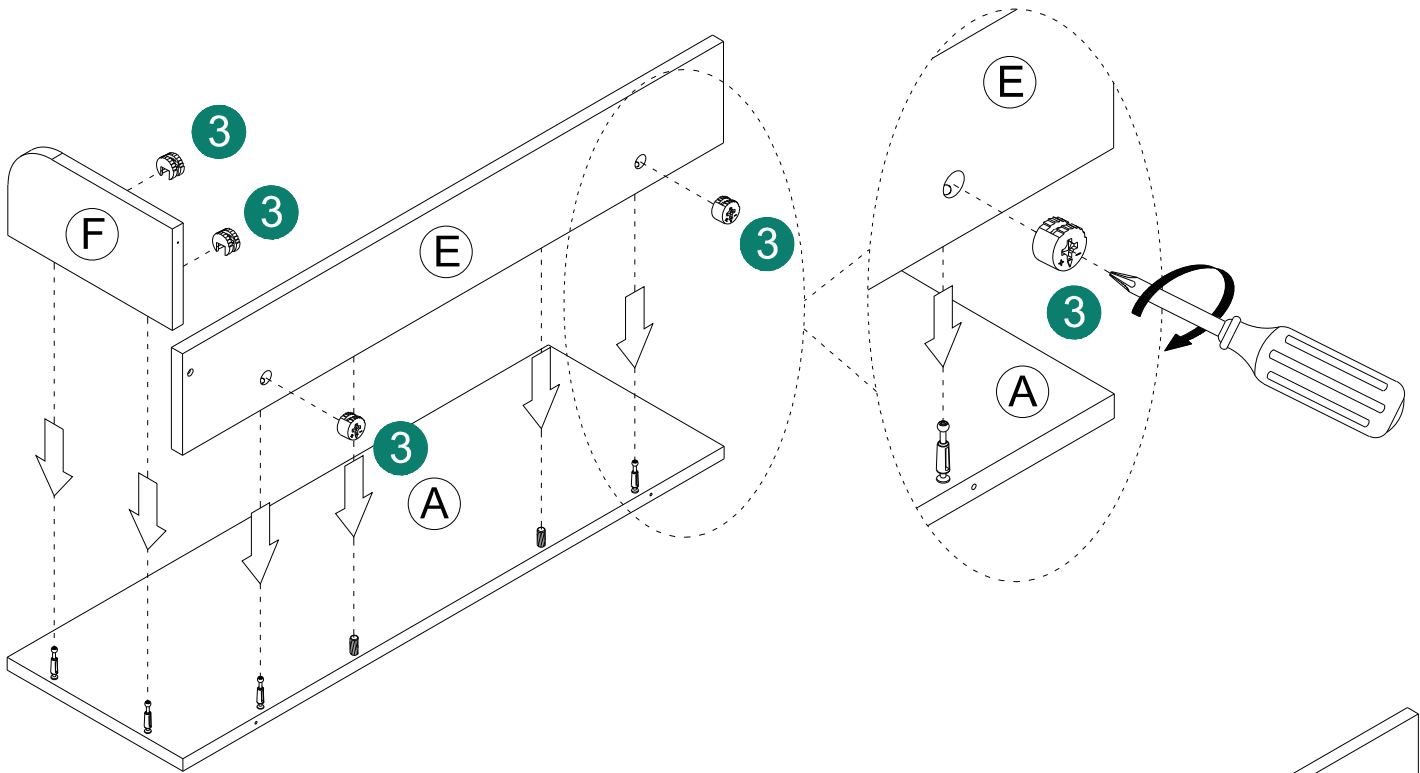

# ASSEMBLY INSTRUCTIONS

3

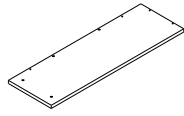

(C) 1pc

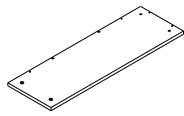

(D) 1pc

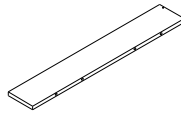

(E) 2pc

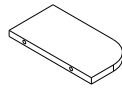

(F) 2pc



(3) 8pcs

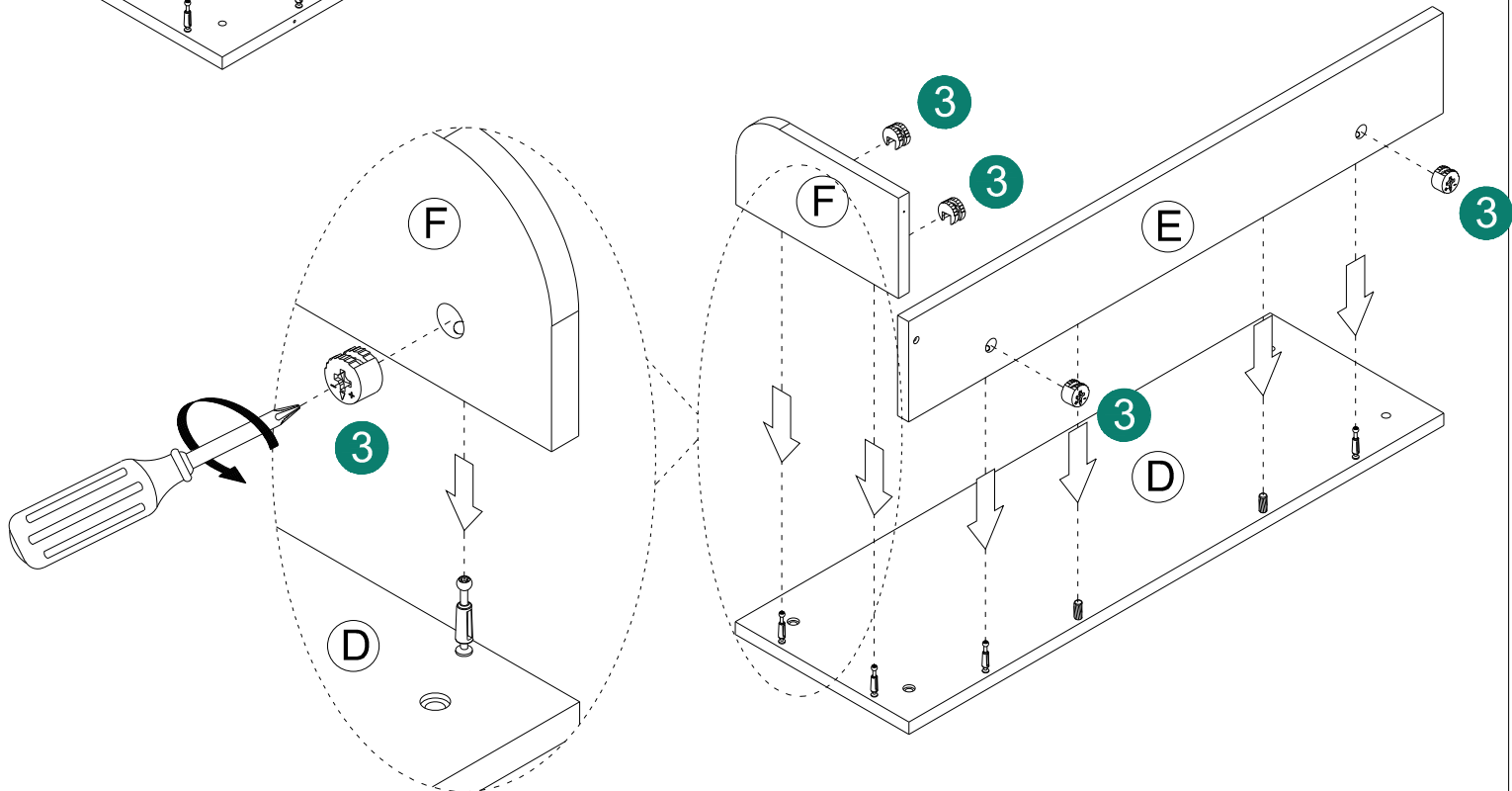
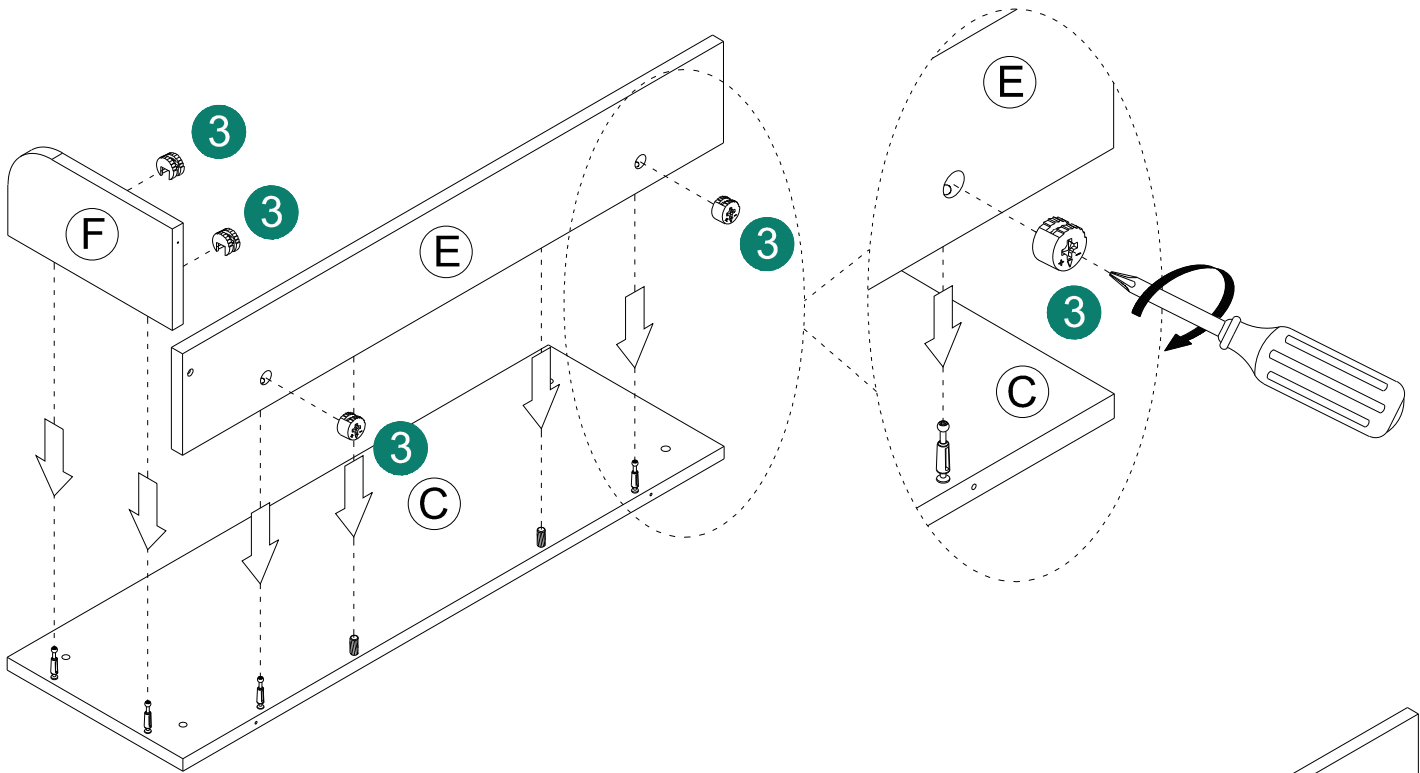

# ASSEMBLY INSTRUCTIONS

4

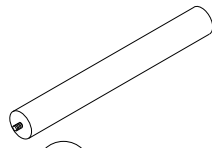

G 2pc

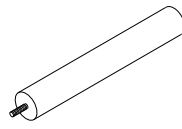

H 2pc

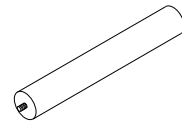

J 2pc

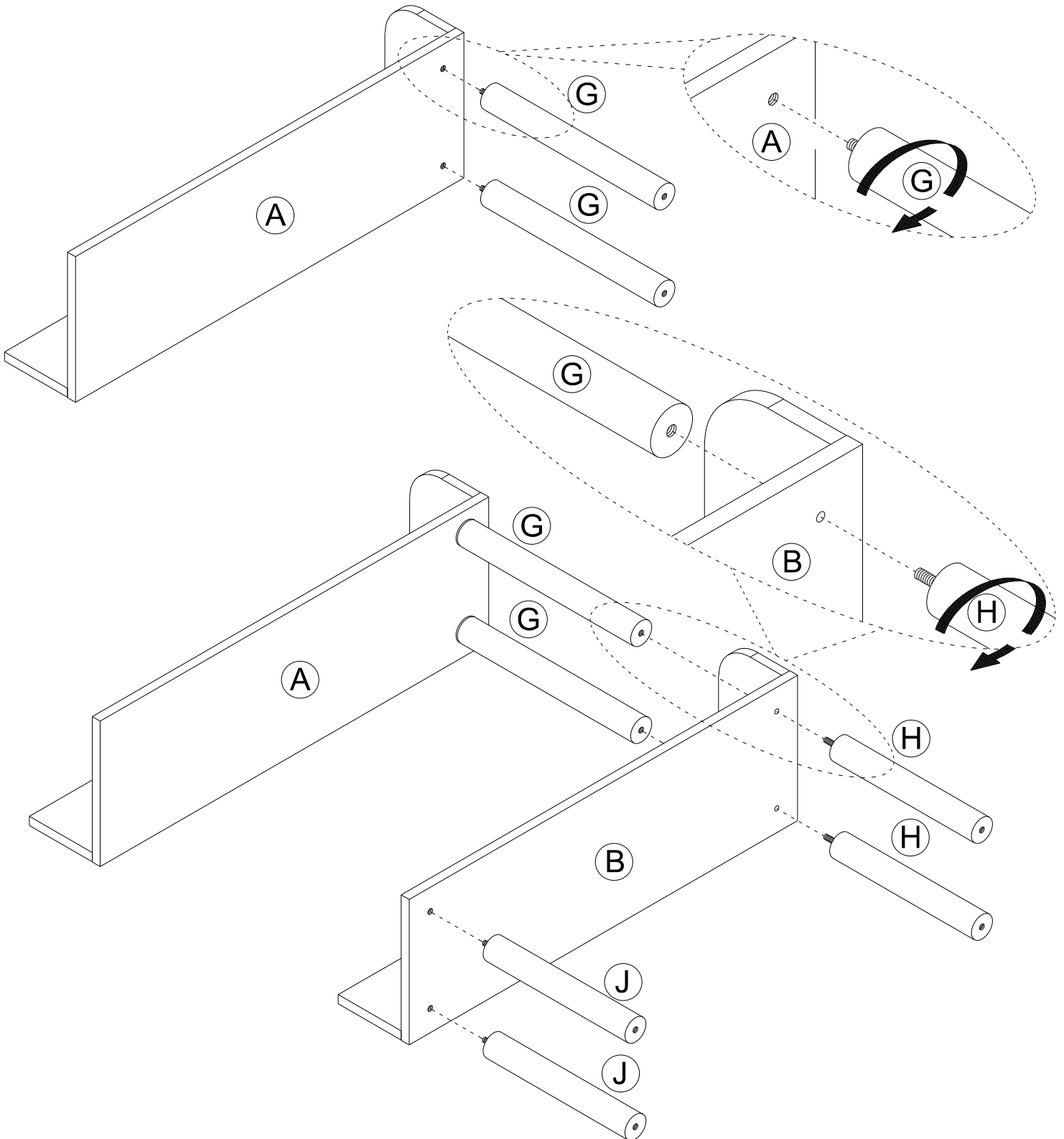

# ASSEMBLY INSTRUCTIONS

5

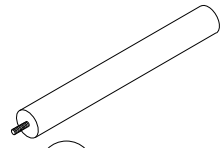

I 2pc



4 2pcs



6 1pc

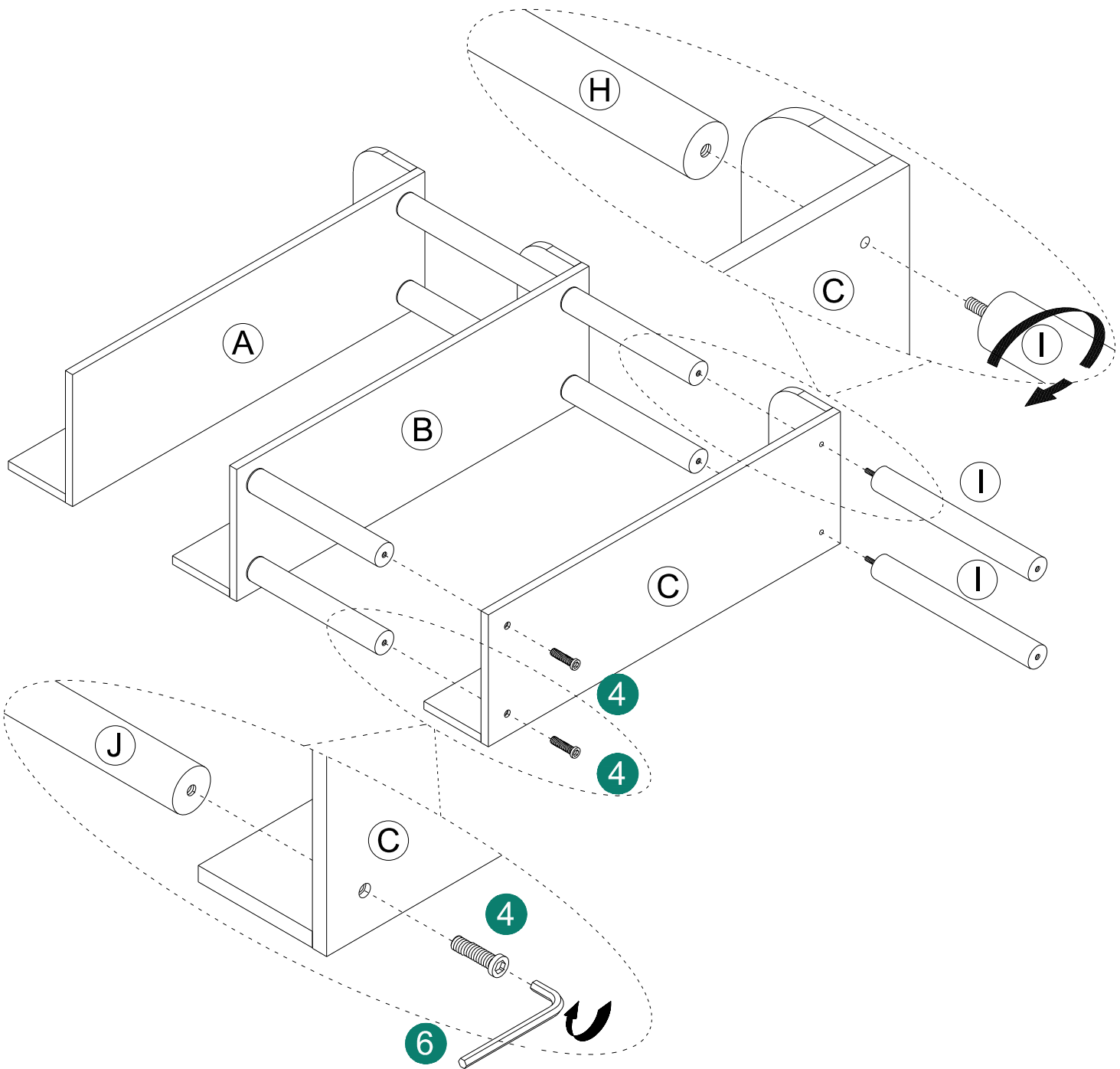

# ASSEMBLY INSTRUCTIONS

6



Ⓚ 2pc



Ⓛ 2pc



④ 2pcs

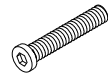

⑤ 4pcs

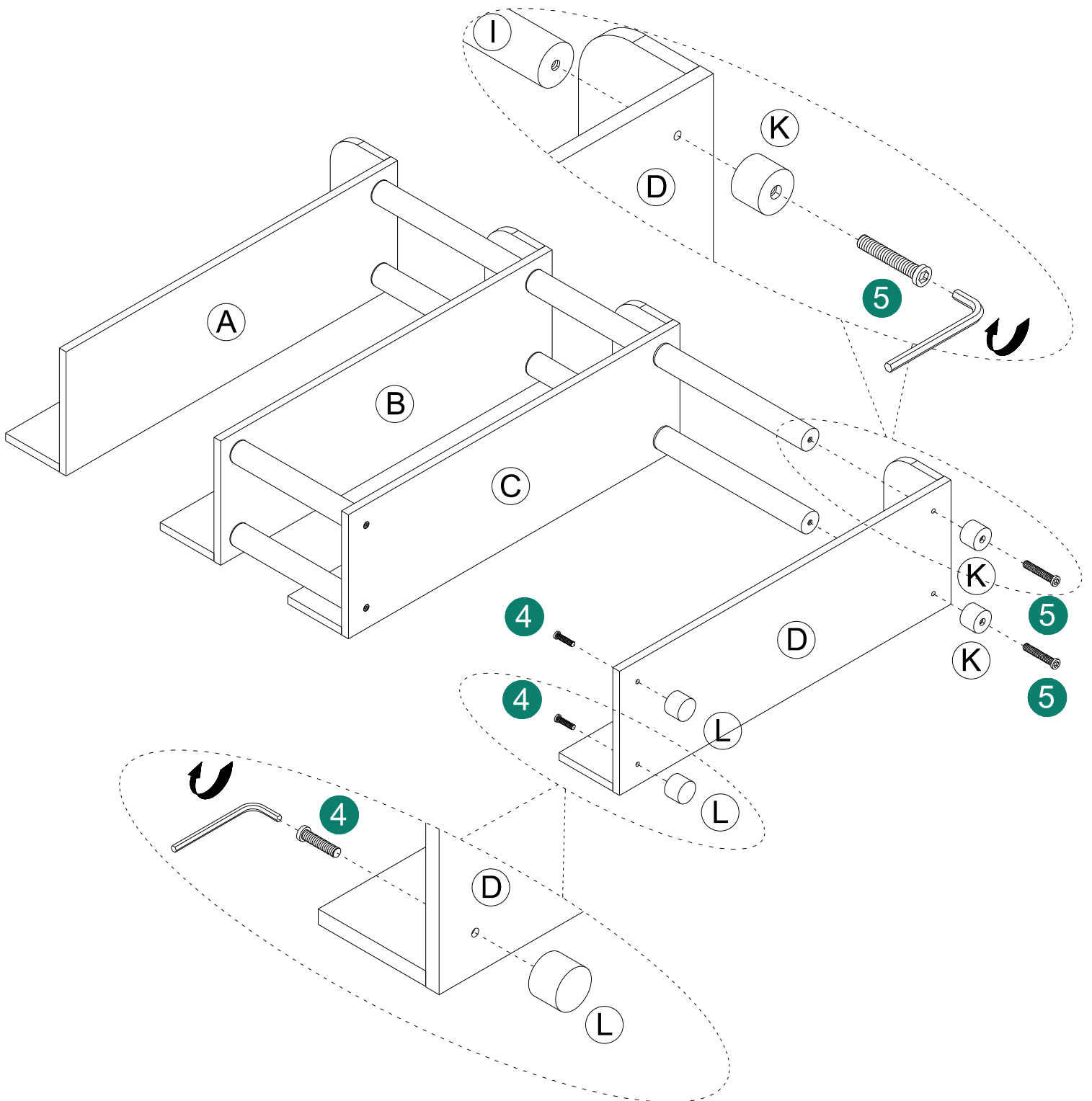

# ASSEMBLY INSTRUCTIONS

7

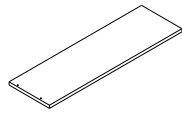

(M) 1pc

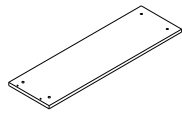

(N) 1pc

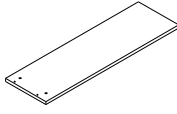

(O) 1pc

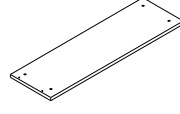

(P) 1pc

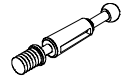

(2) 8pcs

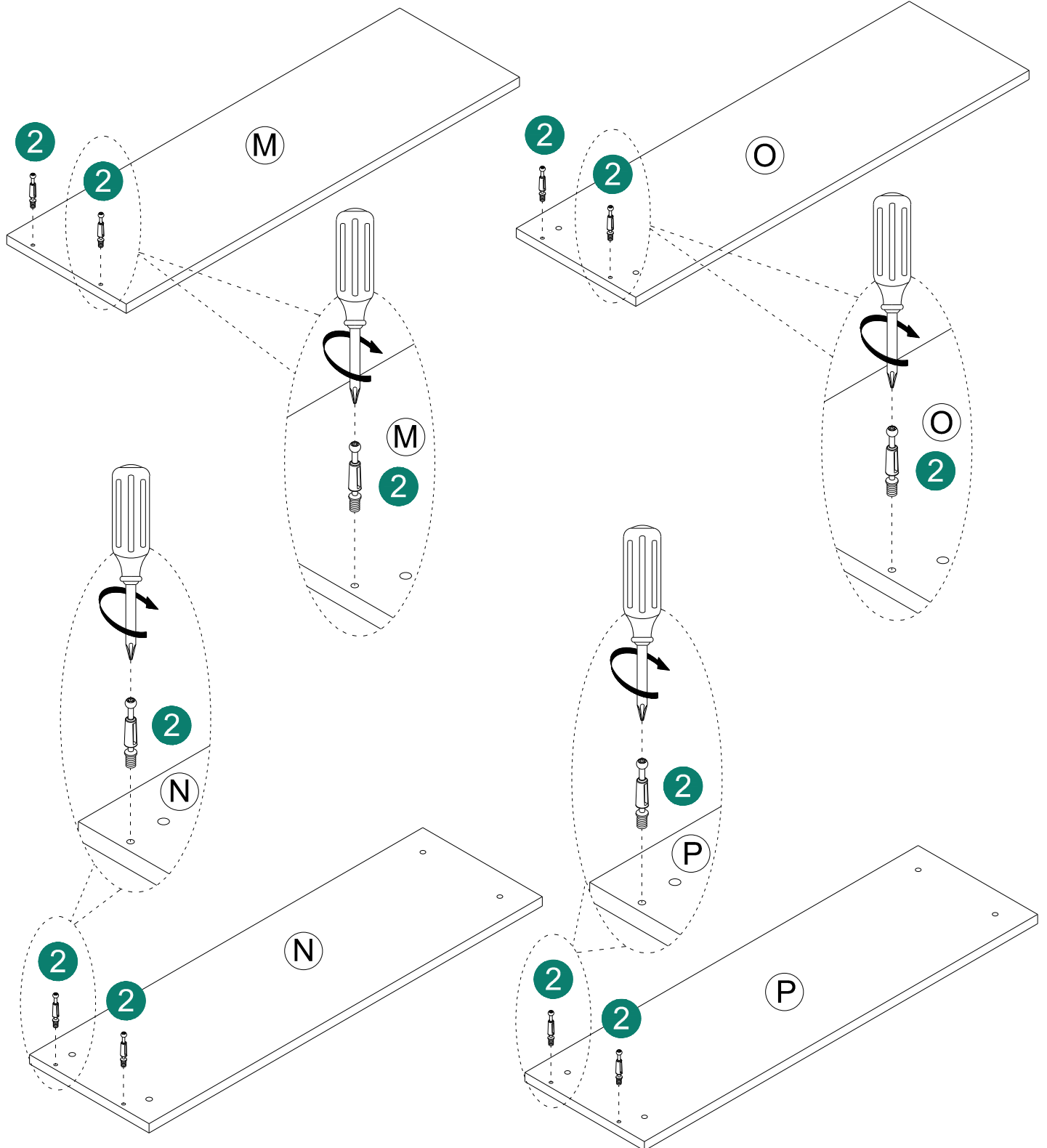

# ASSEMBLY INSTRUCTIONS

8

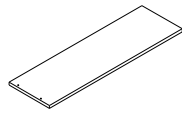

(M) 1pc

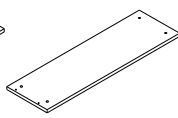

(N) 1pc

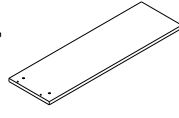

(O) 1pc

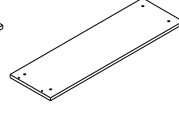

(P) 1pc

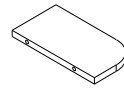

(Q) 4pc



(3) 8pcs

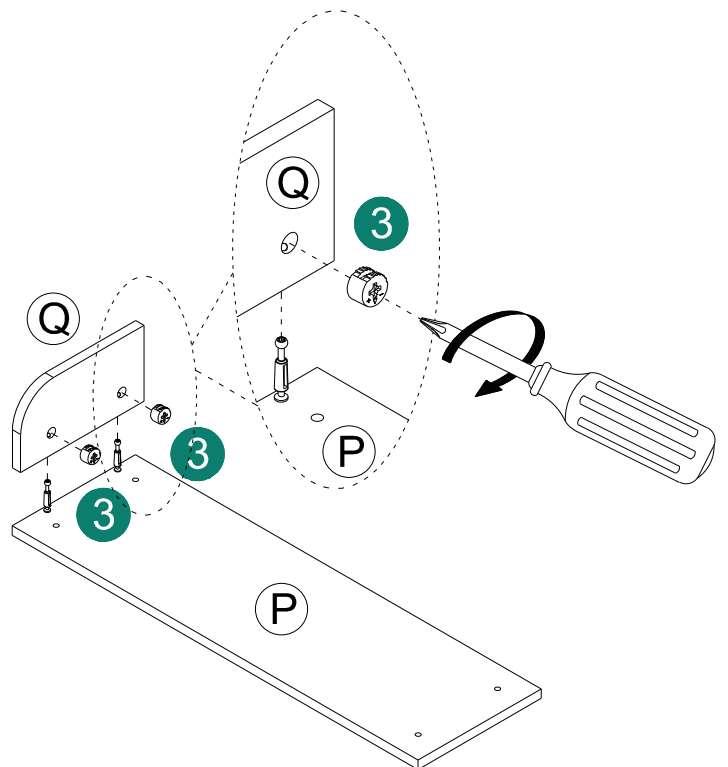
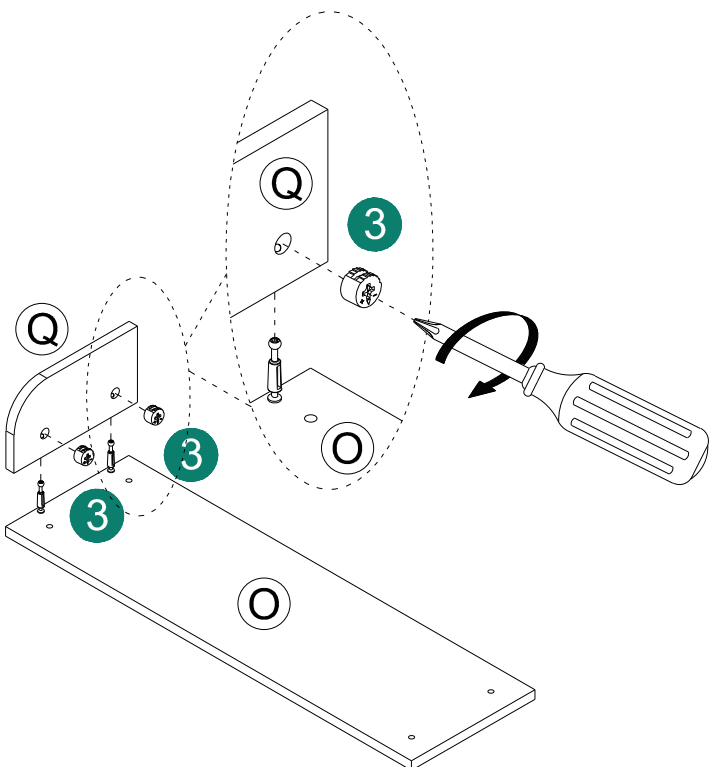
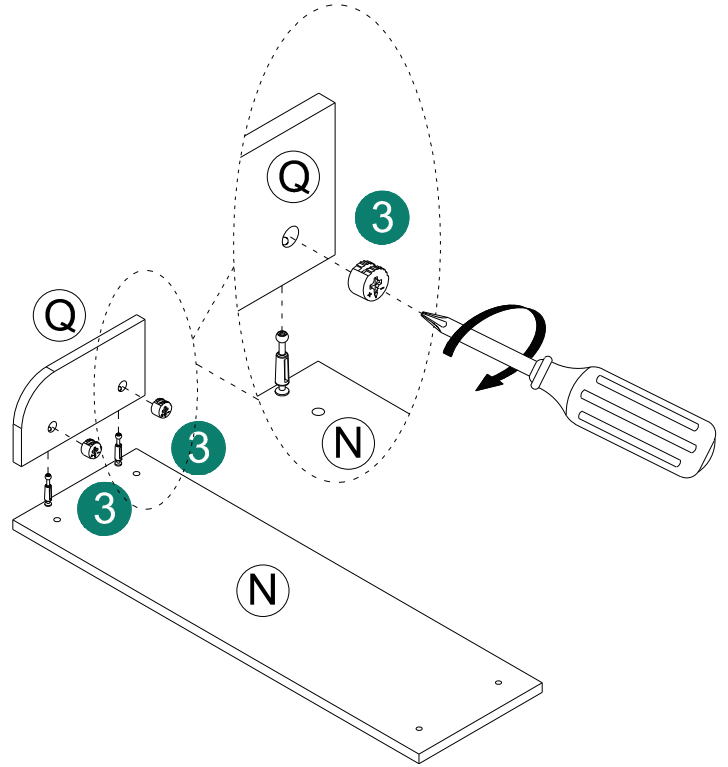
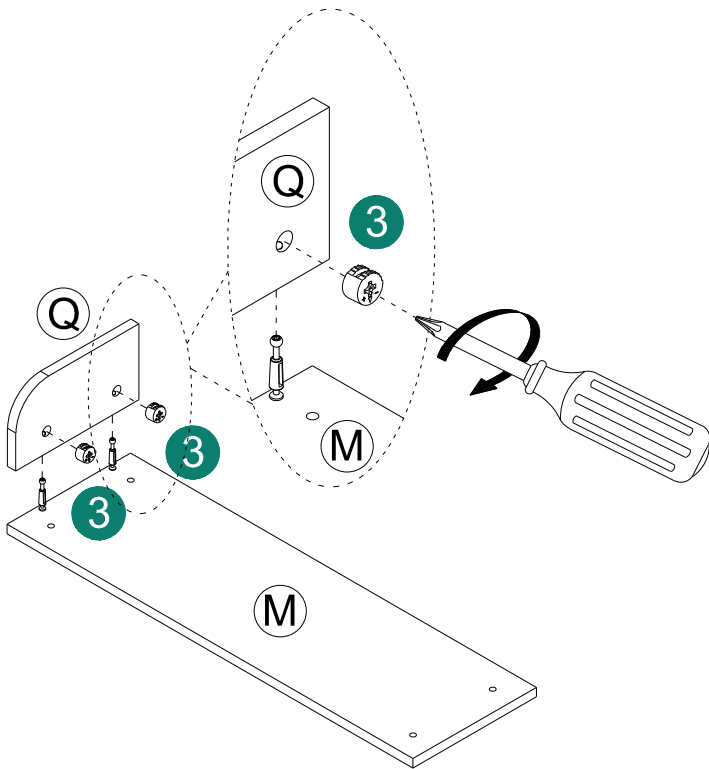

# ASSEMBLY INSTRUCTIONS

9

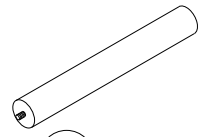

R 4pc

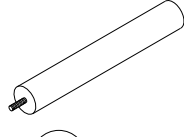

S 2pc



4 2pcs

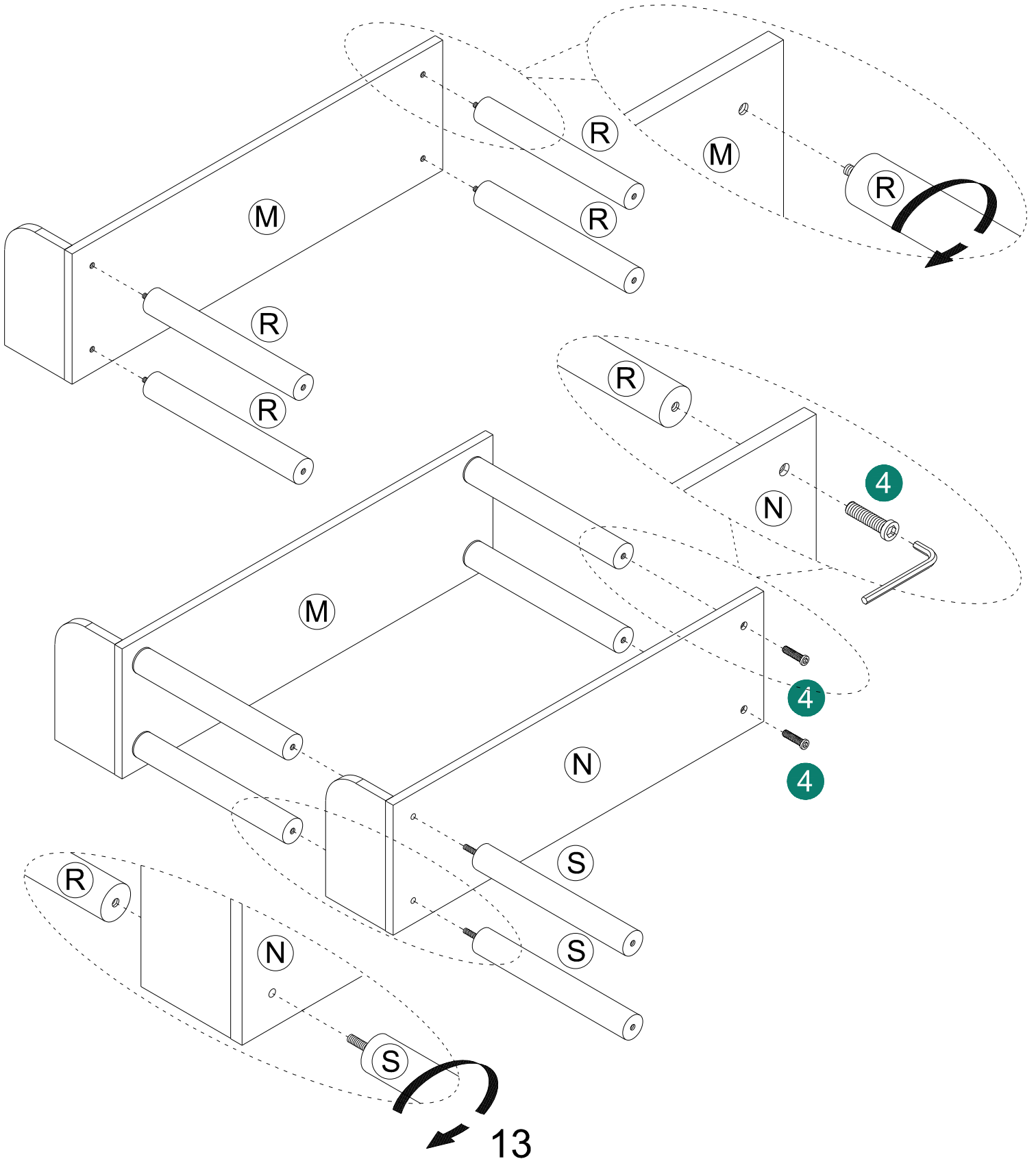

# ASSEMBLY INSTRUCTIONS

10

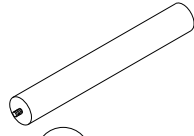

(R) 2pc

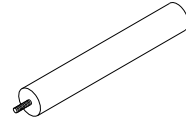

(S) 2pc

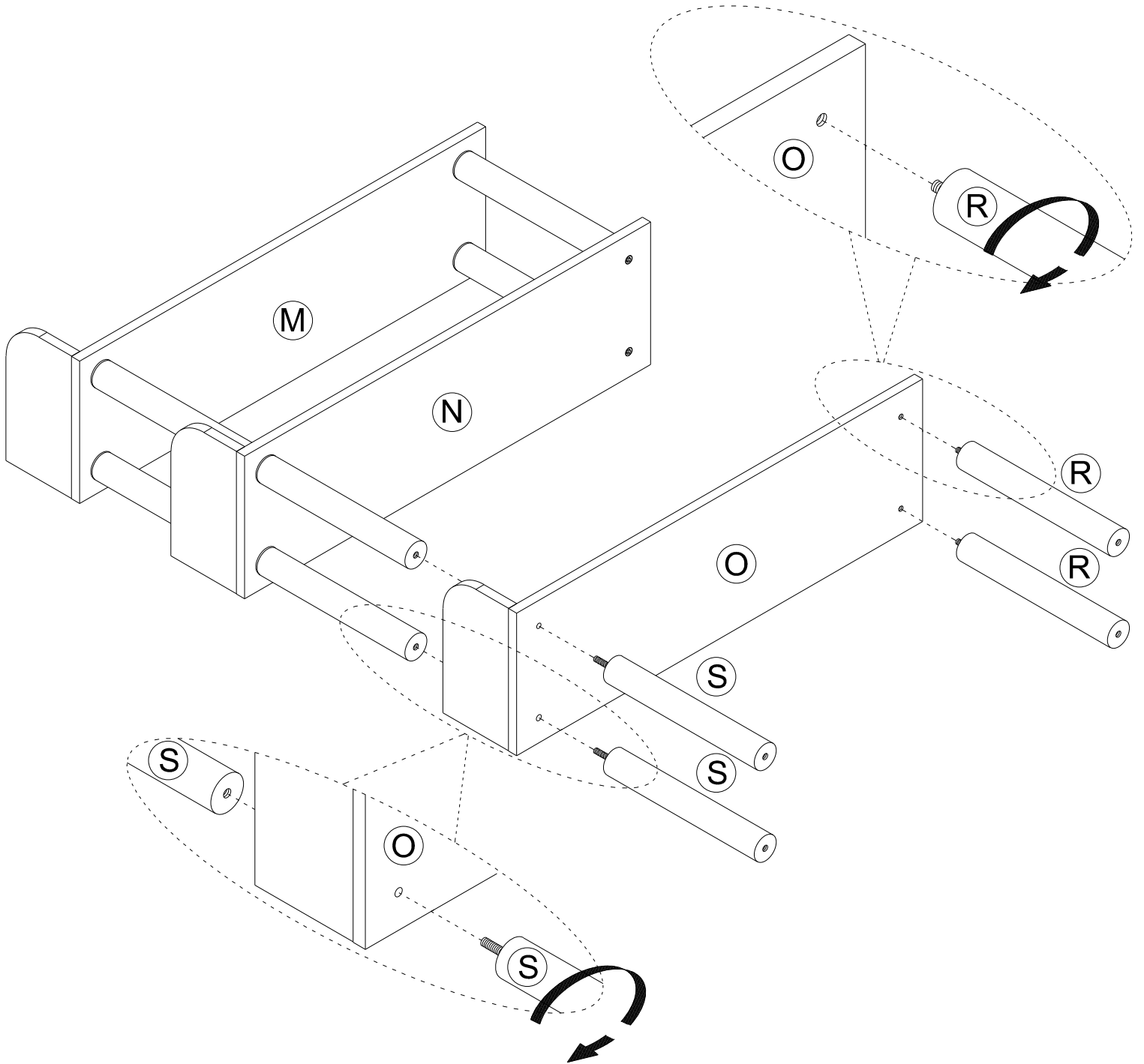

# ASSEMBLY INSTRUCTIONS

11

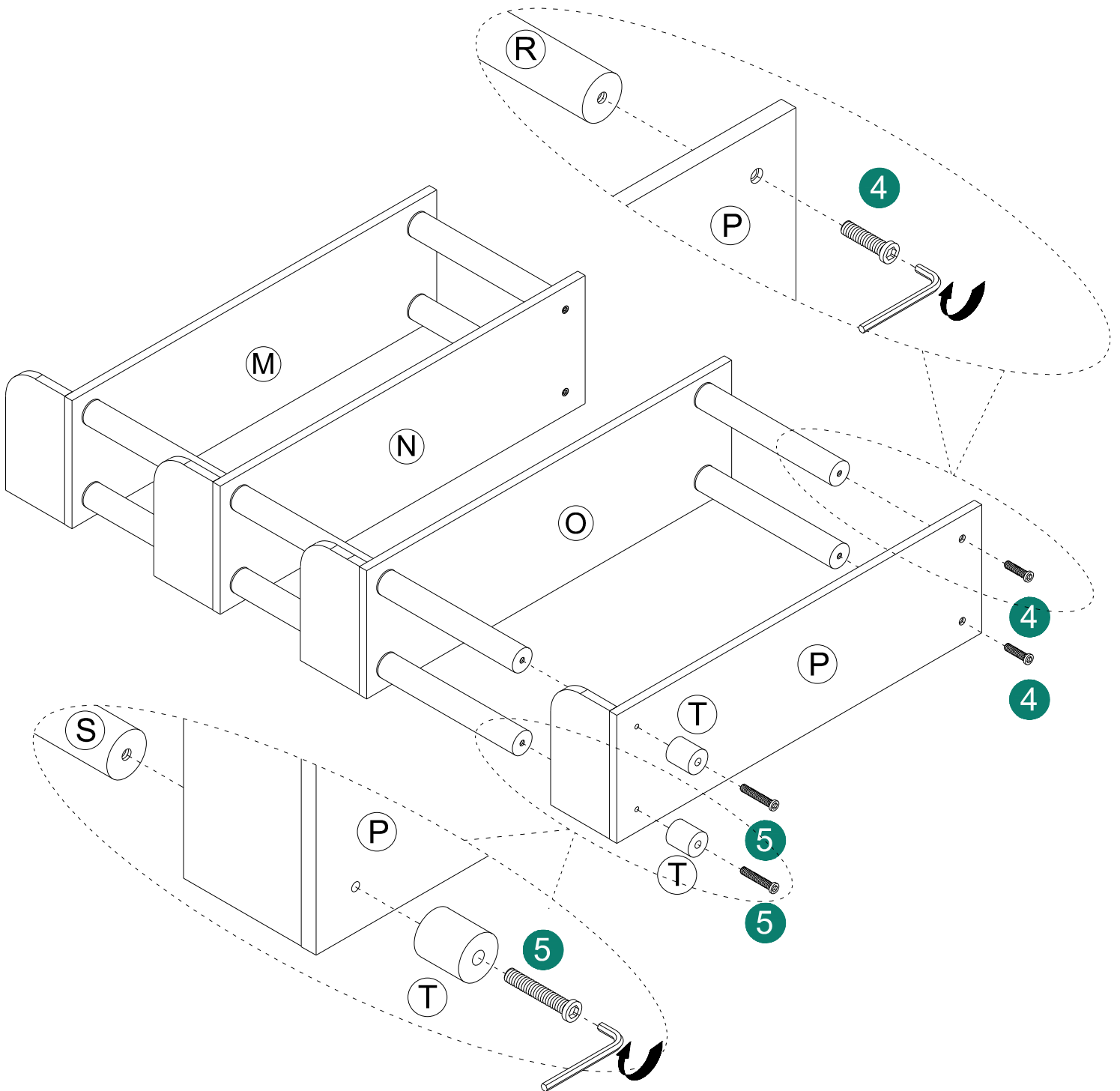
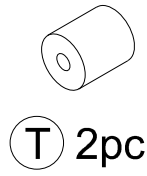

# ASSEMBLY INSTRUCTIONS

12

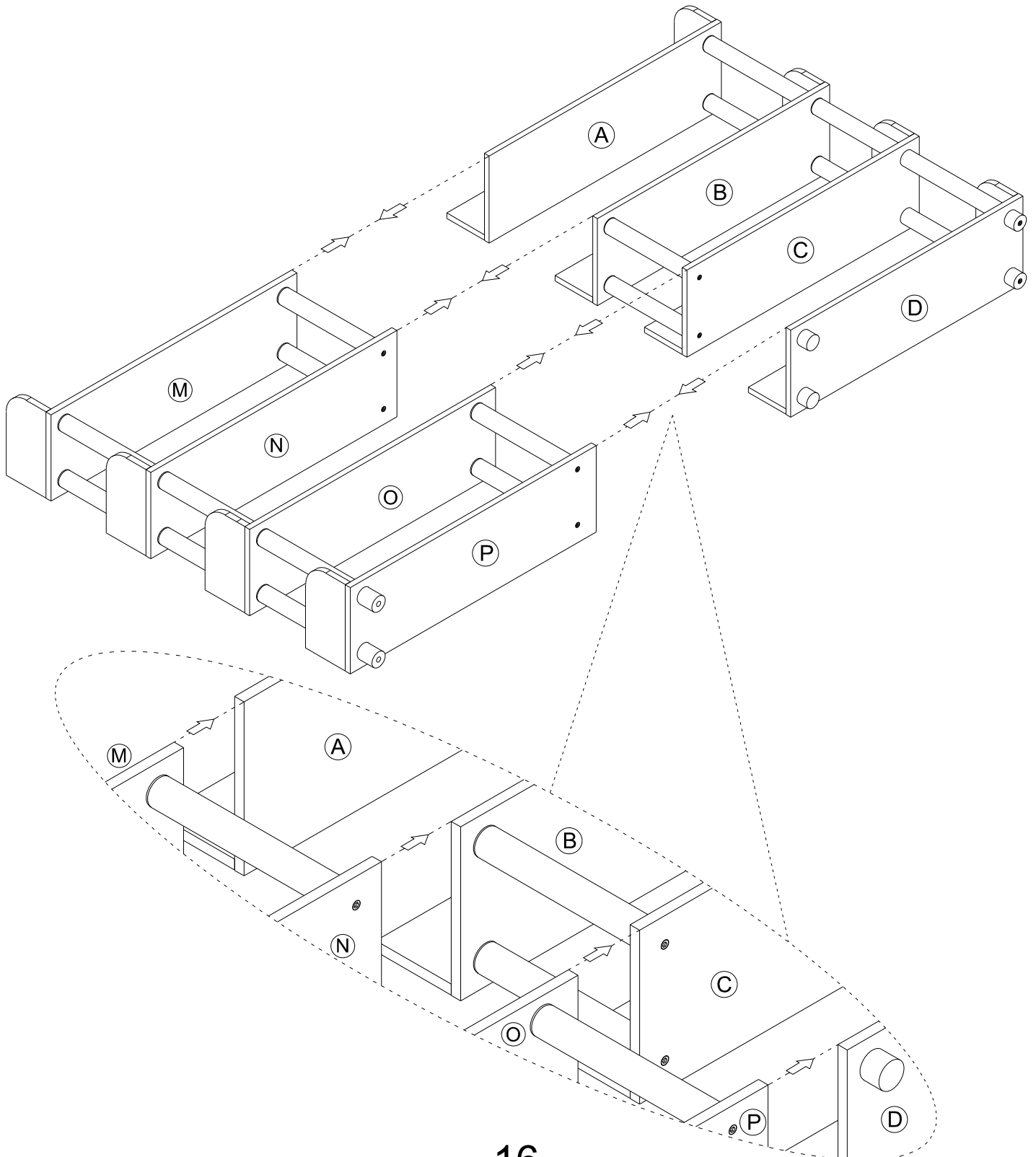

# ASSEMBLY INSTRUCTIONS

13



8 4pcs

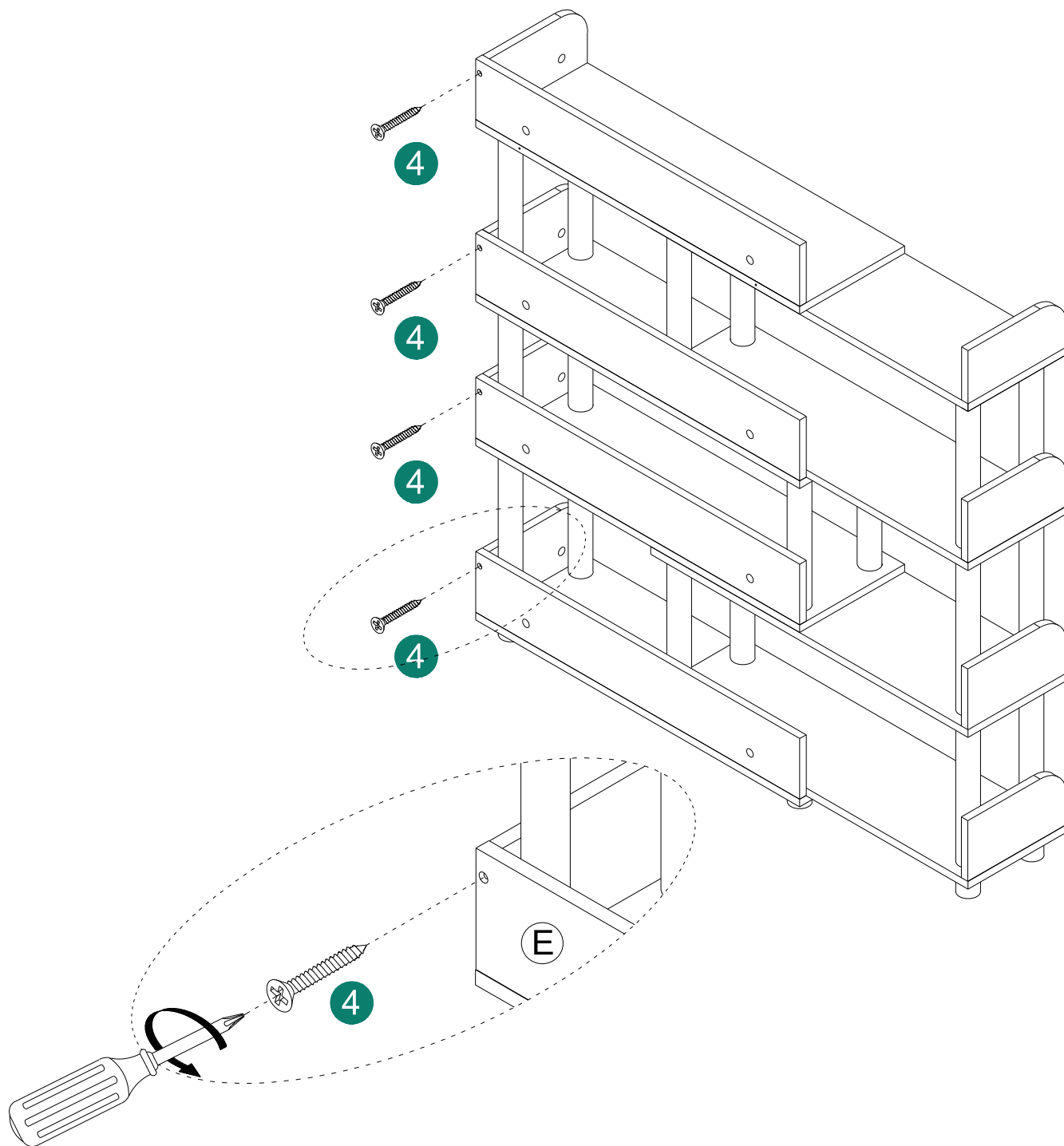

# ASSEMBLY INSTRUCTIONS

14

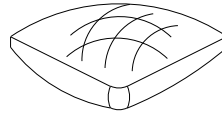

7 2set

A

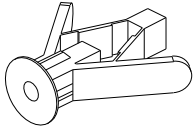

2pcs

B

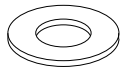

4pcs

C

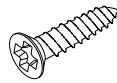

Ø8\*3/4"

2pcs

D

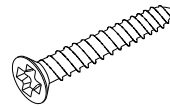

Ø8\*1-1/2"

2pcs

E

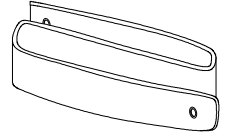

2pcs

WALL

