

WARNING

This portable lamp has a polarized plug (one blade is wider than the other) as a safety feature to reduce the risk of electric shock. This plug will fit in a polarized outlet only one way. If the plug does not fit fully in the outlet, reverse the plug, if it still does not fit, contact a qualified electrician. Never use with an extension cord unless the plug can be fully inserted. Do not attempt to defeat this safety feature.







CARE AND MAINTENANCE

Unplug lamps before using any cleaning solutions. Dust shades with a feather duster or with an appropriate vacuum-brush attachment. Wipe with a soft, dry cloth and clean lamp bases with the methods appropriate to the material. Avoid the use of chemicals and household cleaners as they may damage the finish.

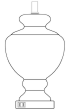
NOTICE & IMPORTANT SAFETY INSTRUCTIONS

- * Please make sure that you have all parts indicated before you begin assembly of this item
- * This item should be assembled on a soft surface to prevent scratching the finish during assembly
- * To reduce the risk of fire, electrical shock or injury to persons or property, please follow the guideline below for safe use and installation
- * The external flexible cable or cord of this luminaire cannot be replaced
- * If the cord is damaged, the luminaire shall be destroyed

Part List and Hardware List

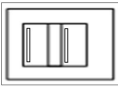
PIECE	DESCRIPTION	PICTURE	QUANTITY	PIECE	DESCRIPTION	PICTURE	QUANTITY
A	Lamp base		1X	E	Shade		1X
B	Saddle		1X	F	Finial		1X
C	Socket		1X	G	Bulb		1X
D	Harp		1X	H	USB		1X

Product Dimensions: 15" L x 15"W x 27.75"H

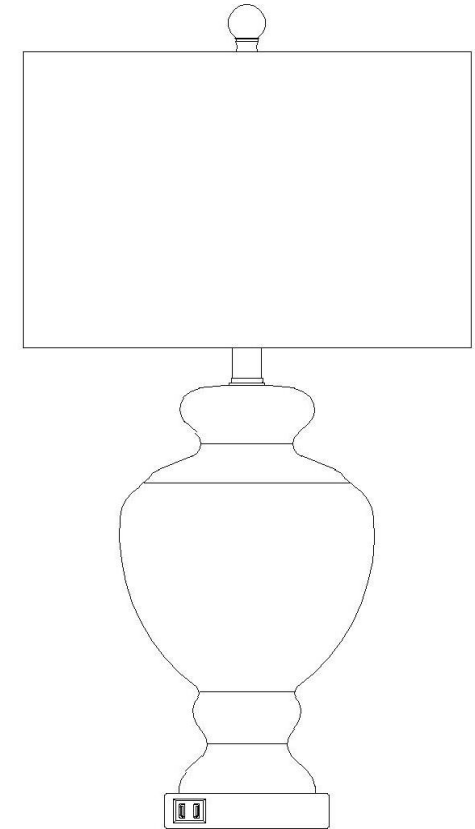

PREPARATION

- * Before beginning assembly of product, make sure all parts are present. Compare parts with package contents list and hardware contents list.
- * If any part is missing or damaged, do not attempt to assemble the product.
- * Estimated Assembly Time: 6 minutes.
- * If you are having difficulty, our friendly Customer Care team is always here to help.

NOTE: PLEASE USE ON/OFF TYPE "A" BULB MAX 100-WATT OR LED BULB MAX 12-WATT, THERE IS LED 9-WATT BULB IN THE BOX

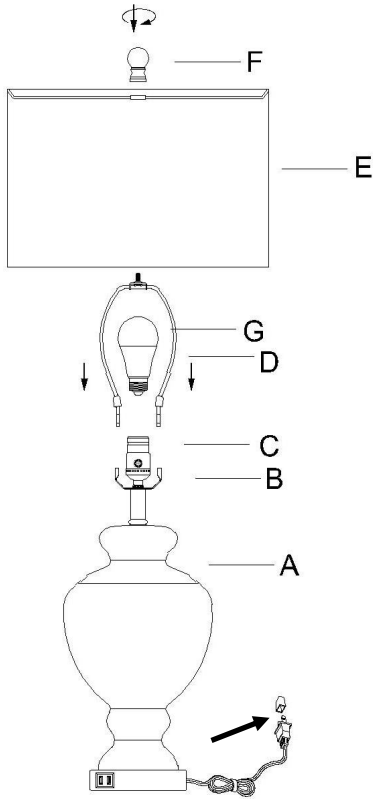

Step1: Insert the Harp (D) into the Saddle (B). Put the shade (E) on the Harp (D), then tighten the Finial (F) into the Harp (D), Insert the bulb (G) into the socket (C). Be careful not to twist the power cord and tighten securely.

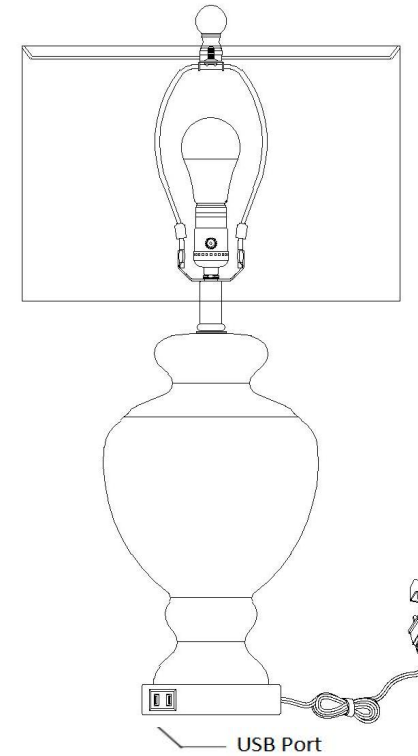

Step2: Put the light on a level surface to check if everything is stable. There is a USB port on the side of bottom base, the USB port enables to charge mobile phones, the charging function is available whether the lamp is on or off.