

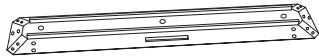













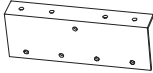





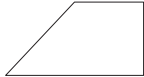
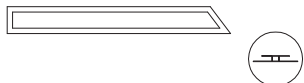

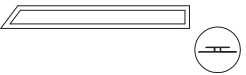
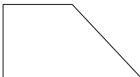
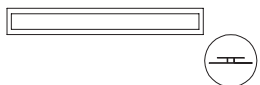





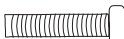

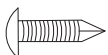
! "IMPORTANT, RETAIN FOR FUTURE REFERENCE: READ CAREFULLY"

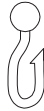
1. Gather and organize all required parts prior to assembly.
2. Assemble on a flat, clean and soft surface.

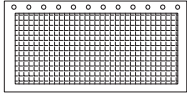
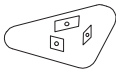
Item no.	Reference Image	Qty.	Item no.	Reference Image	Qty.
A		X4	P		X1
B		X2	Q		X1
C		X2	R		X4
D		X2	S		X4
E		X2	T		X6
F		X4	U		X4
G		X6	V		X4
H		X4	W		X4
I		X4	X		X4
J		X2	Y		X4
K		X8	Z		X4
L		X8	1	 M6 X 15MM	X102
M		X2	2	 M6 X 50MM	X2
N		X4	3	 φ4 X 10MM	X28
O		X4	4	 M6 X 15MM	X50

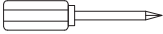
Item no.	Reference Image	Qty.	Item no.	Reference Image	Qty.
5		X88	9		X8
6		X4	10		X4
7		X4	11		X1
8		X1	12		X2

1



Ⓐ 4pcs



Ⓑ 2pcs



Ⓒ 2pcs

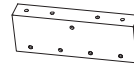

Ⓢ 2pcs



④ 28pcs

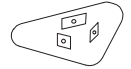

⑩ 4pcs

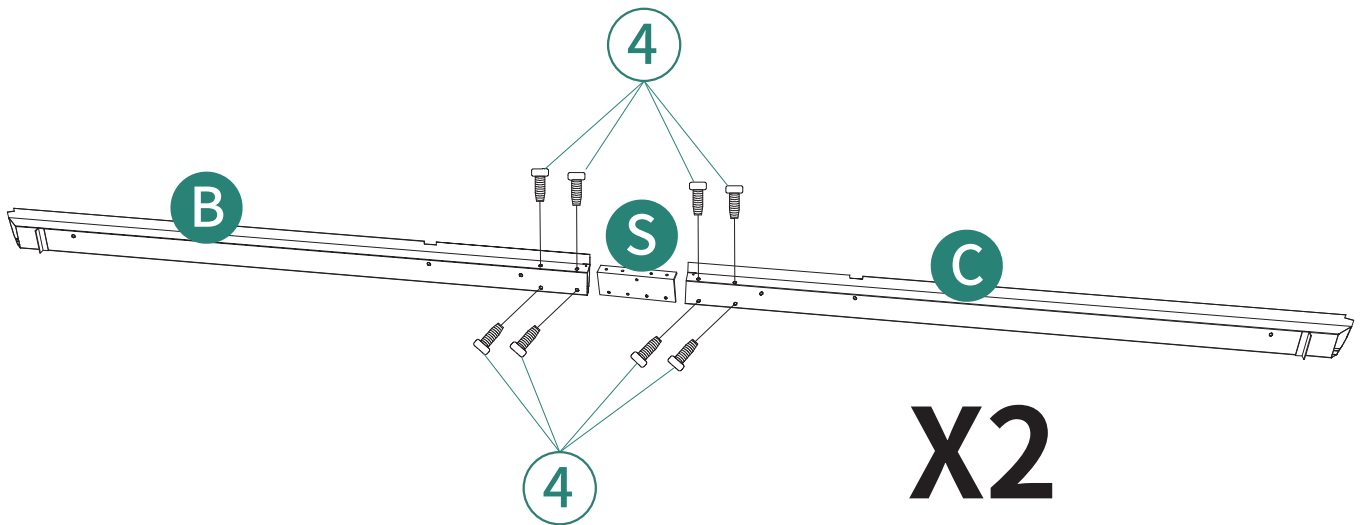
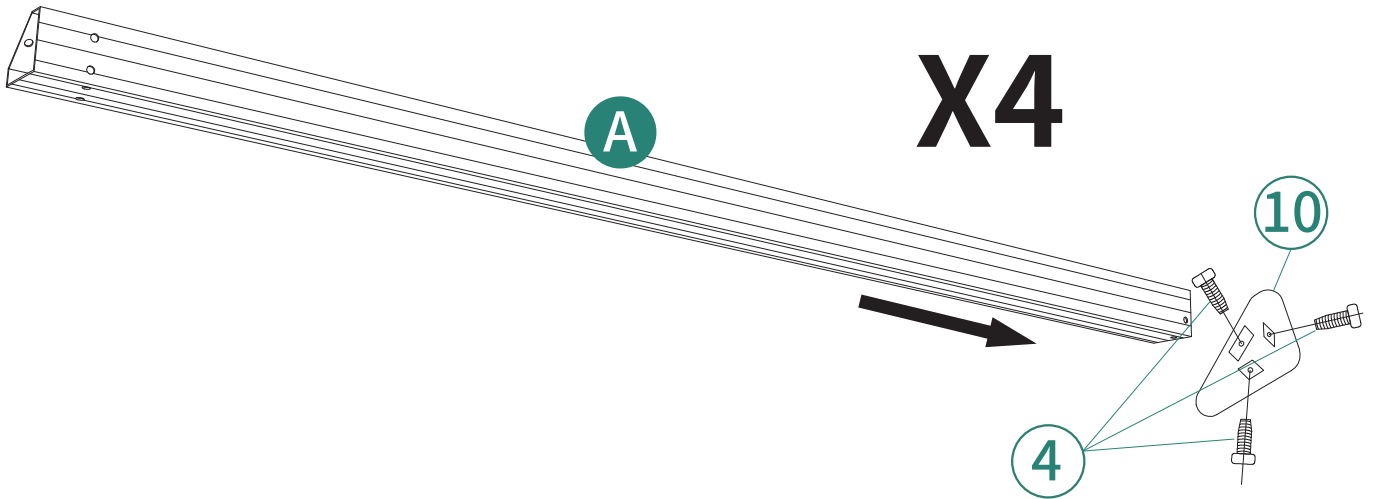

2
X2

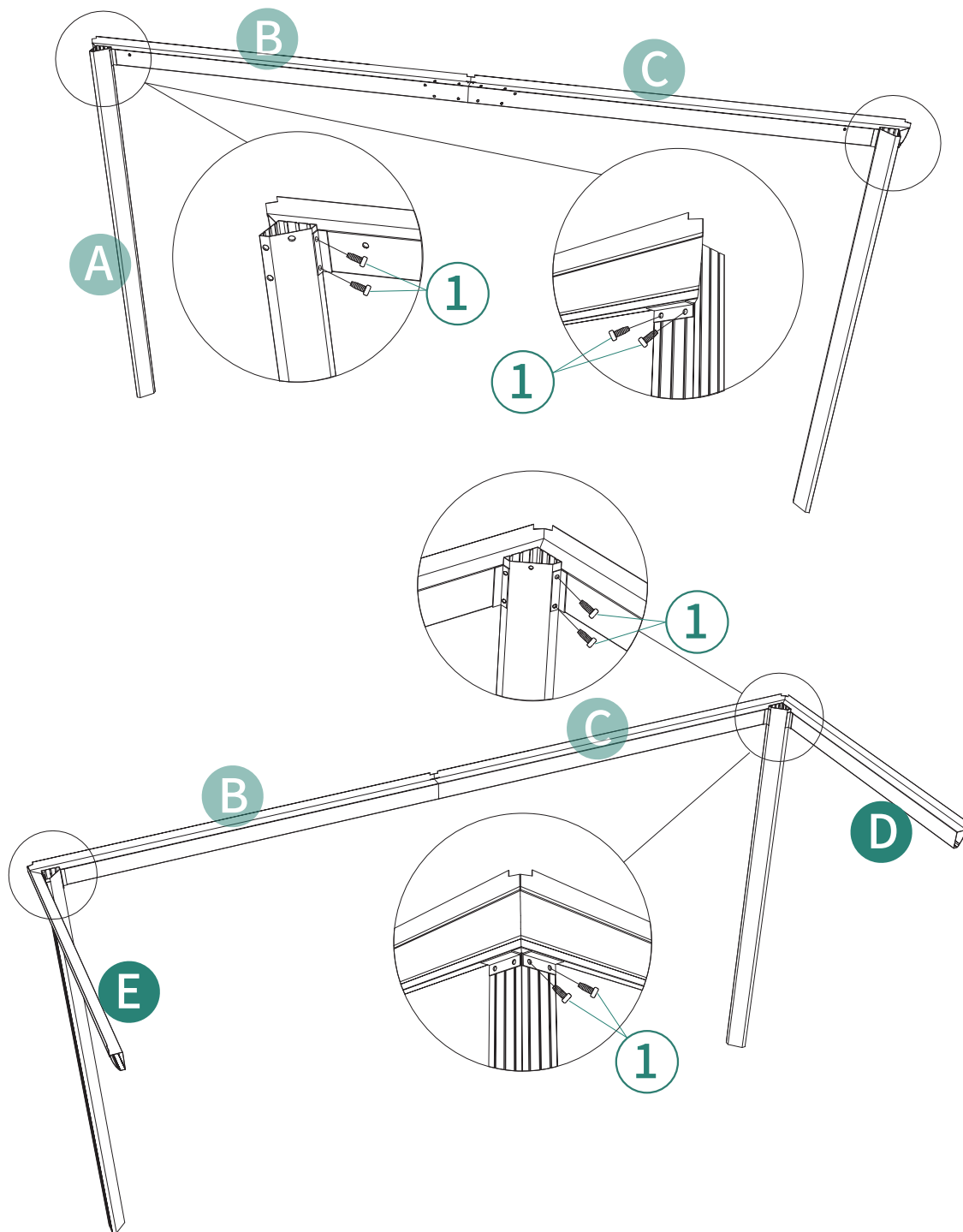
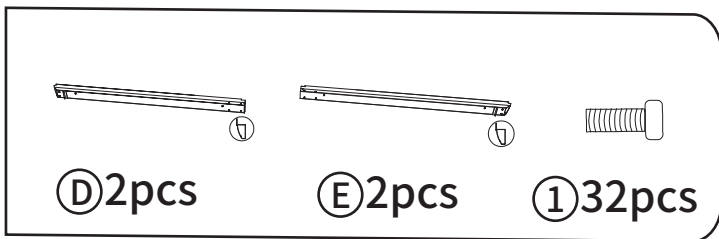

3

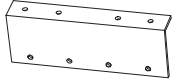

Ⓢ 2pcs

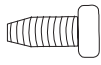

④ 16pcs

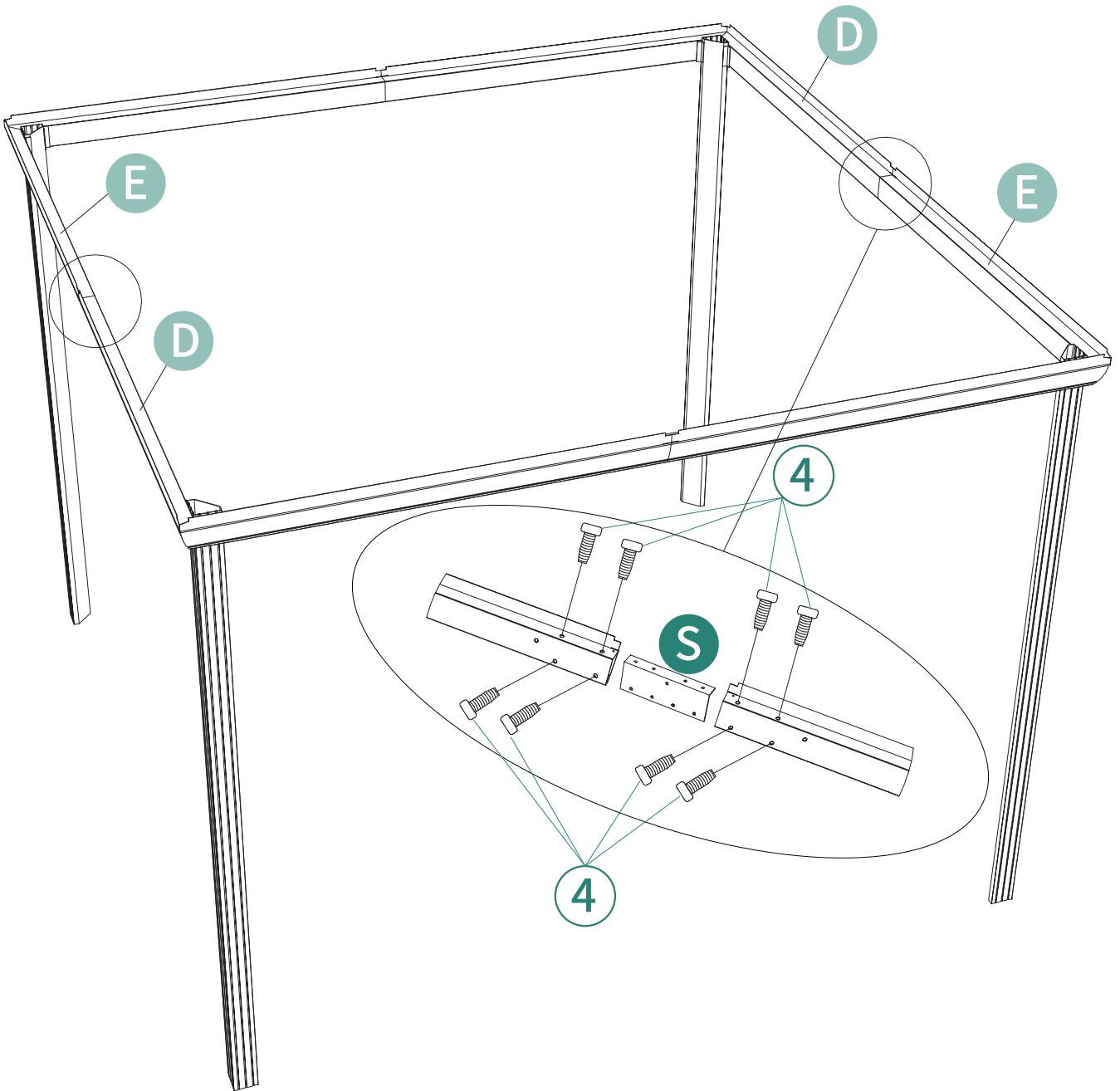

4



⓪ 2pcs



① 2pcs



① 8pcs



⑤ 88pcs

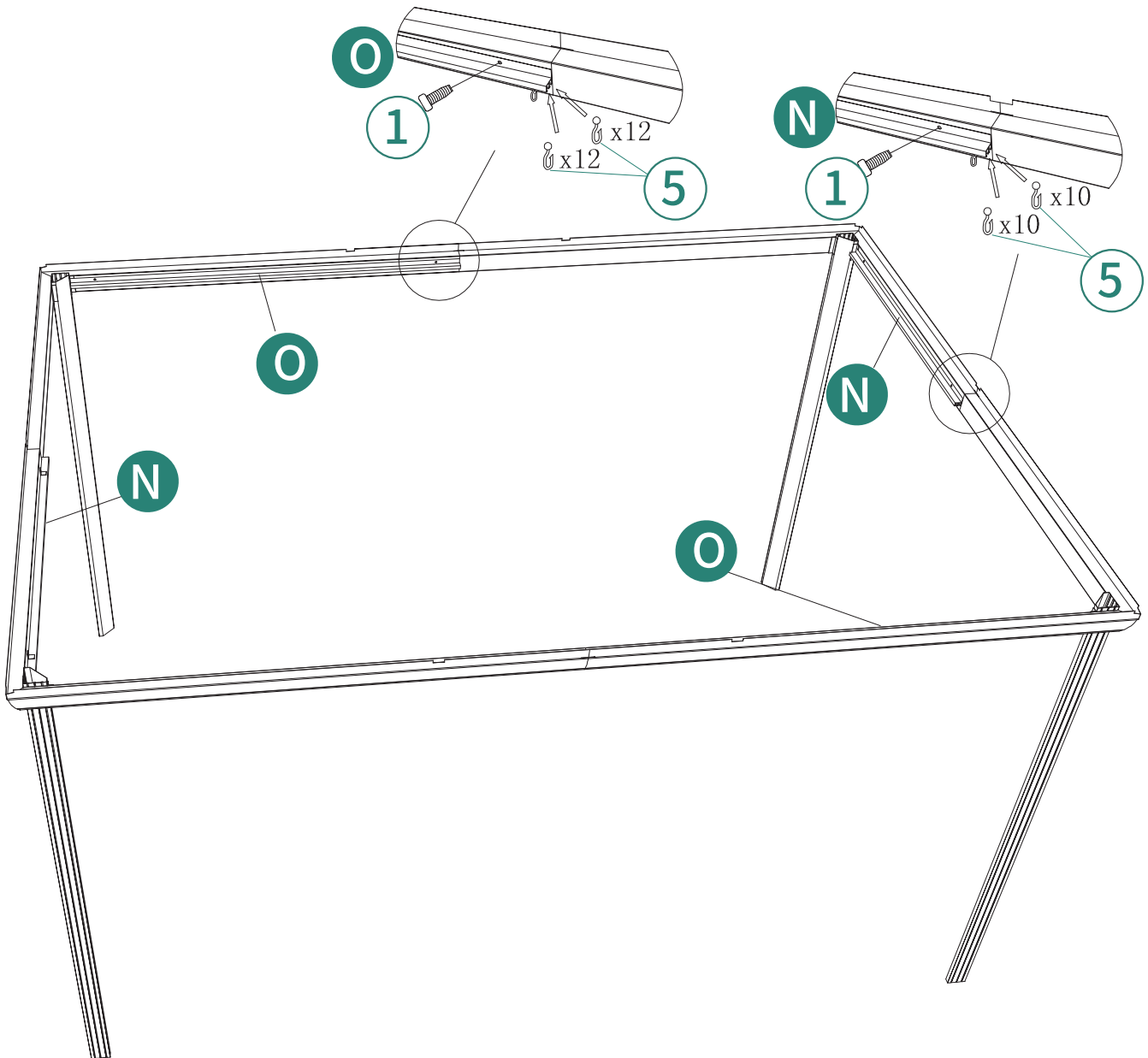

5



Ⓝ 2 pcs Ⓞ 2 pcs ① 8 pcs

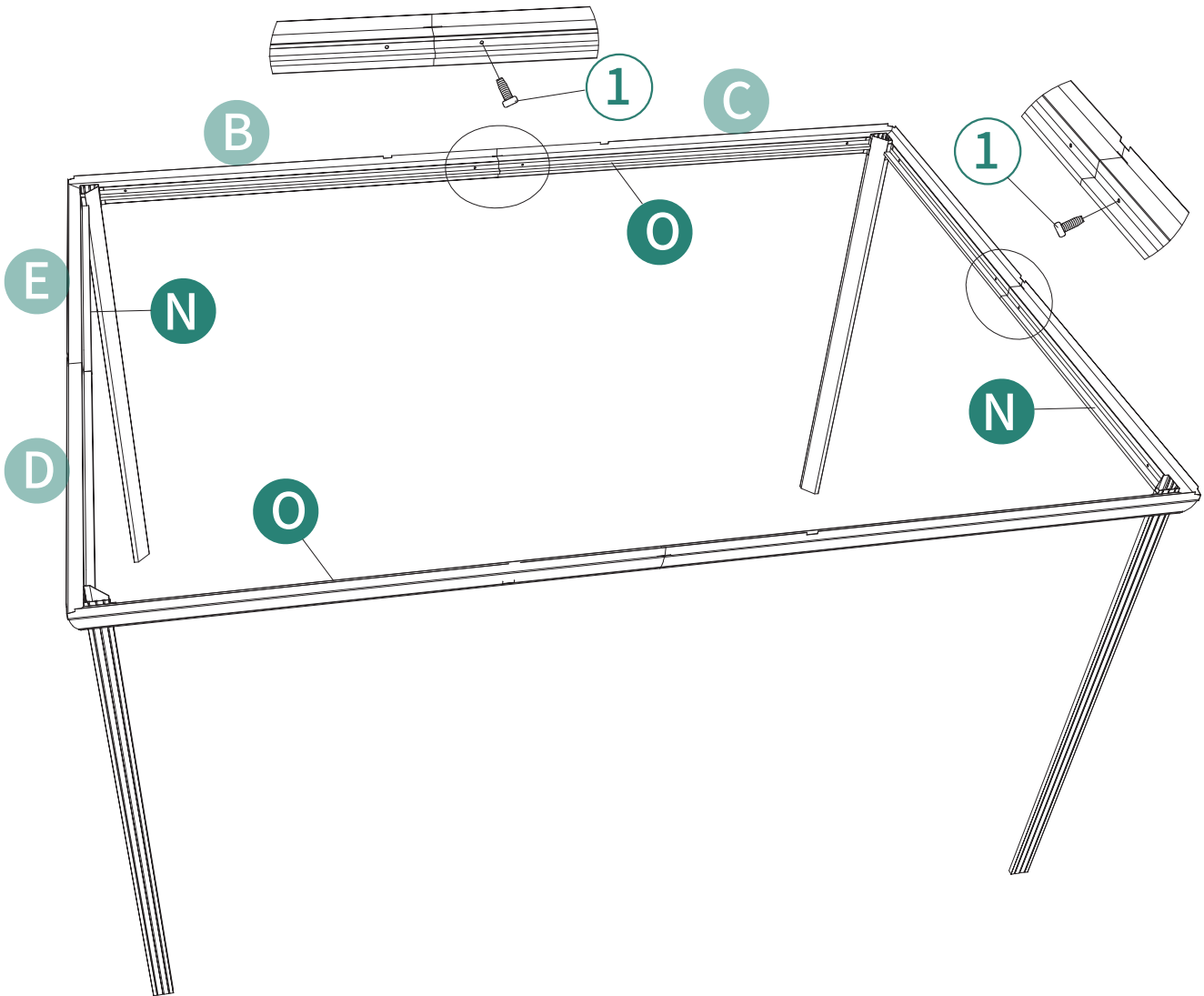

6



Ⓚ8pcs



Ⓡ4pcs



①16pcs







③8pcs

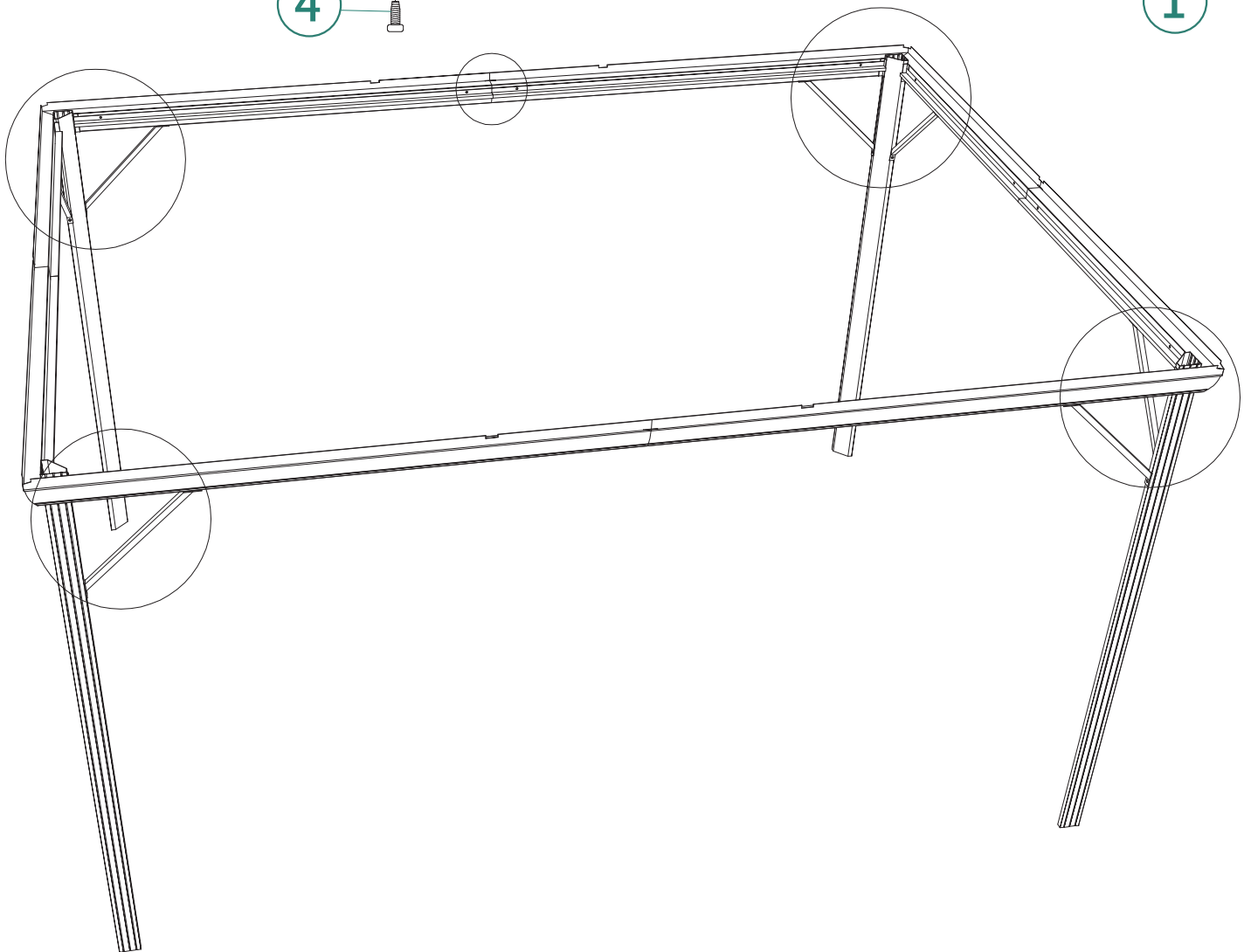
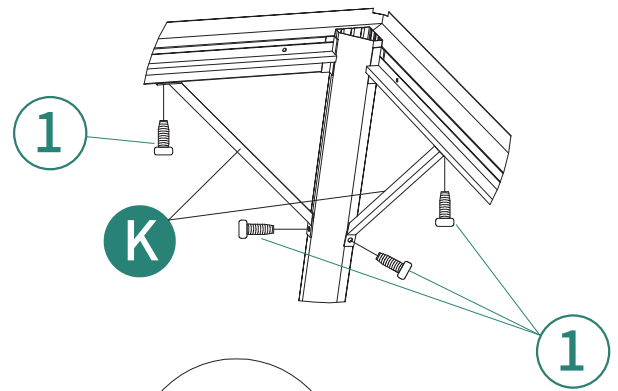
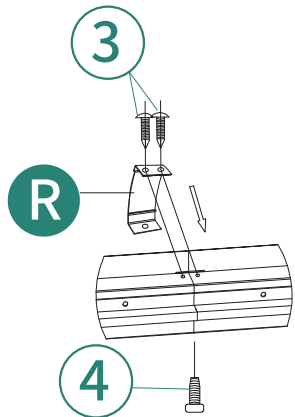

④4pcs



7

-  **F** 4pcs
-  **G** 6pcs
-  **P** 1pc
-  **Q** 1pc
-  **1** 20pcs
-  **2** 2pcs
-  **11** 1pc

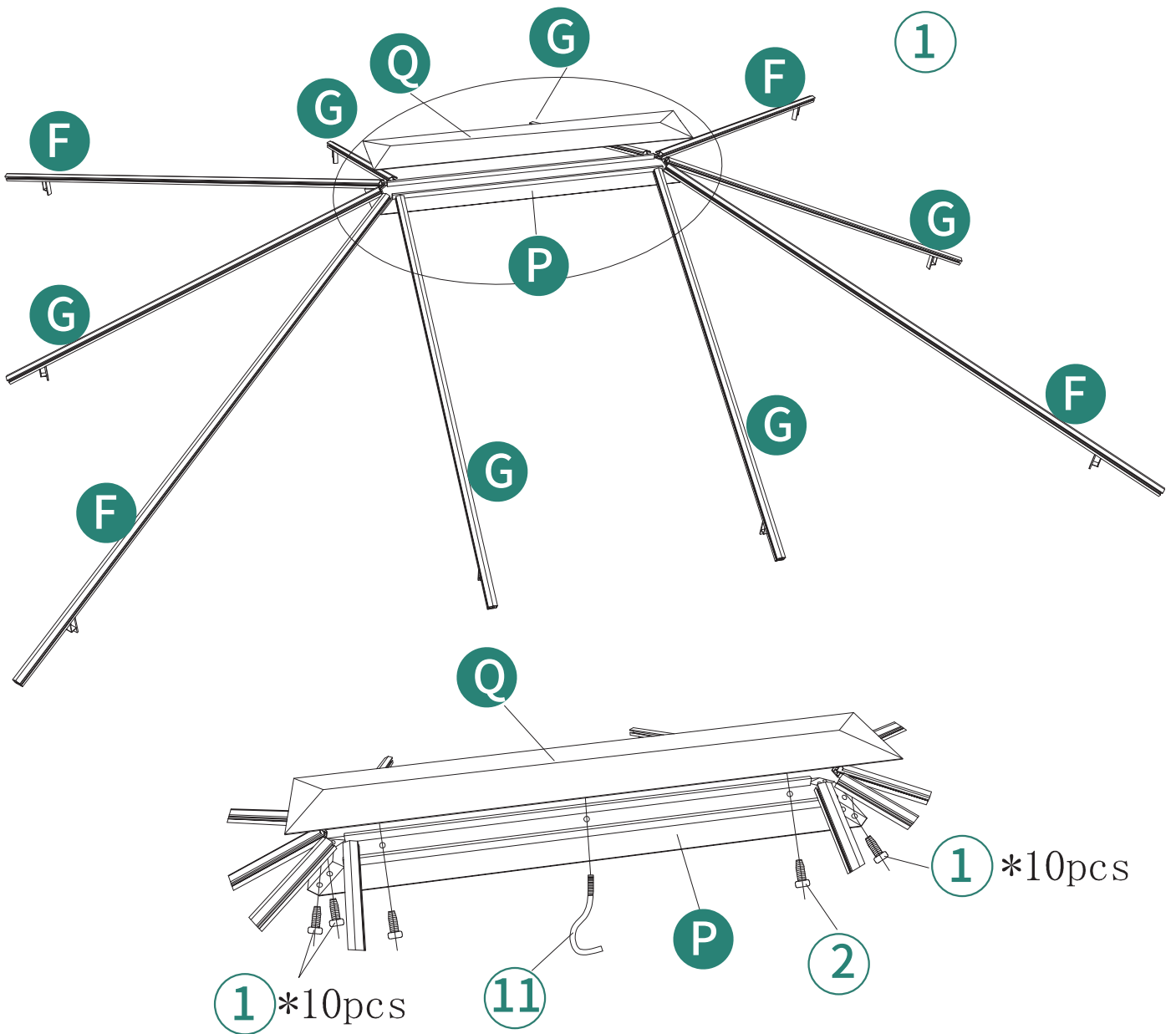

8



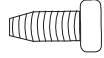

① 8pcs

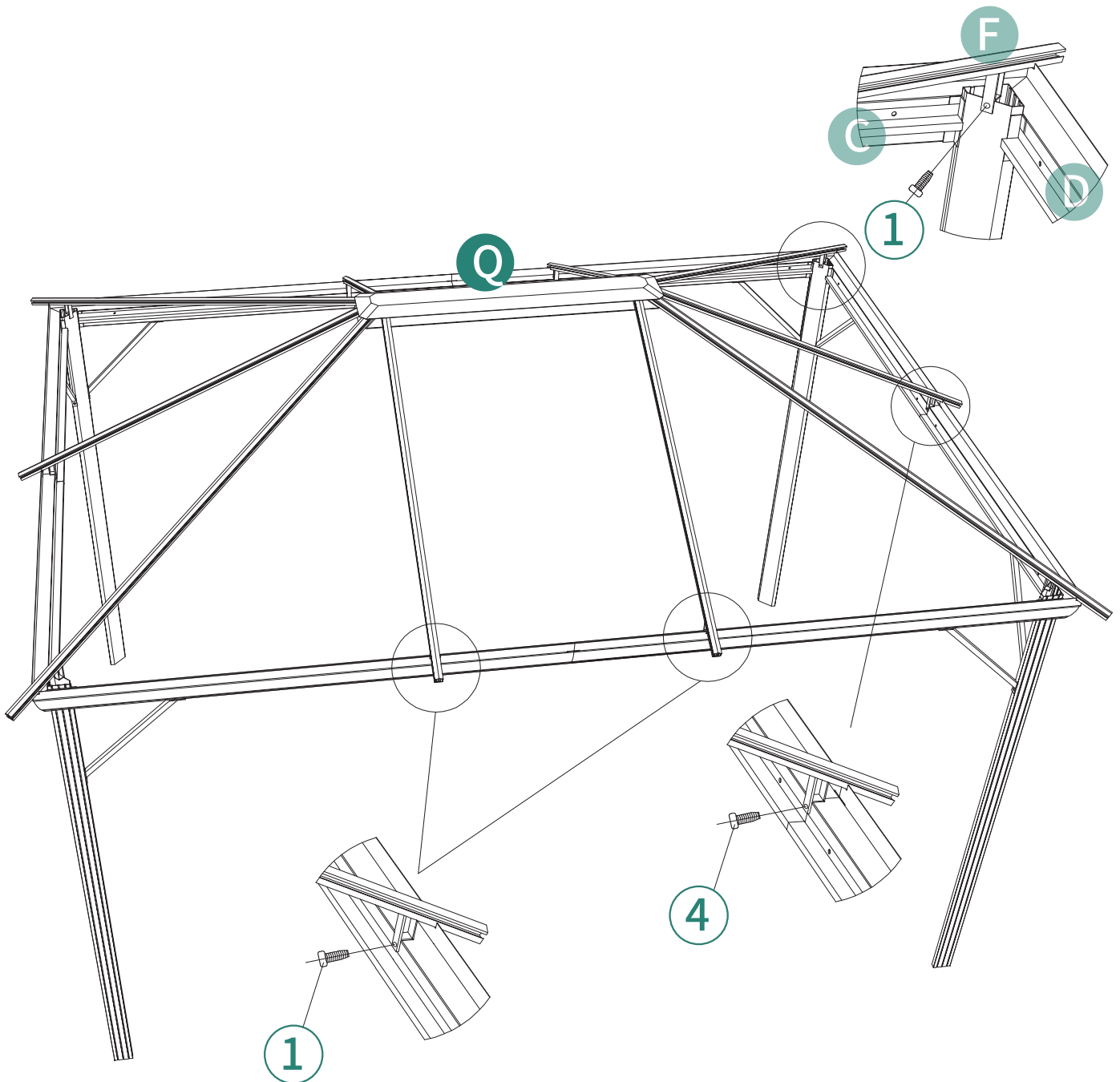

④ 2pcs



9

     
Ⓜ4pcs Ⓜ4pcs Ⓜ2pcs Ⓜ4pcs Ⓜ4pcs Ⓜ4pcs Ⓜ4pcs Ⓜ4pcs

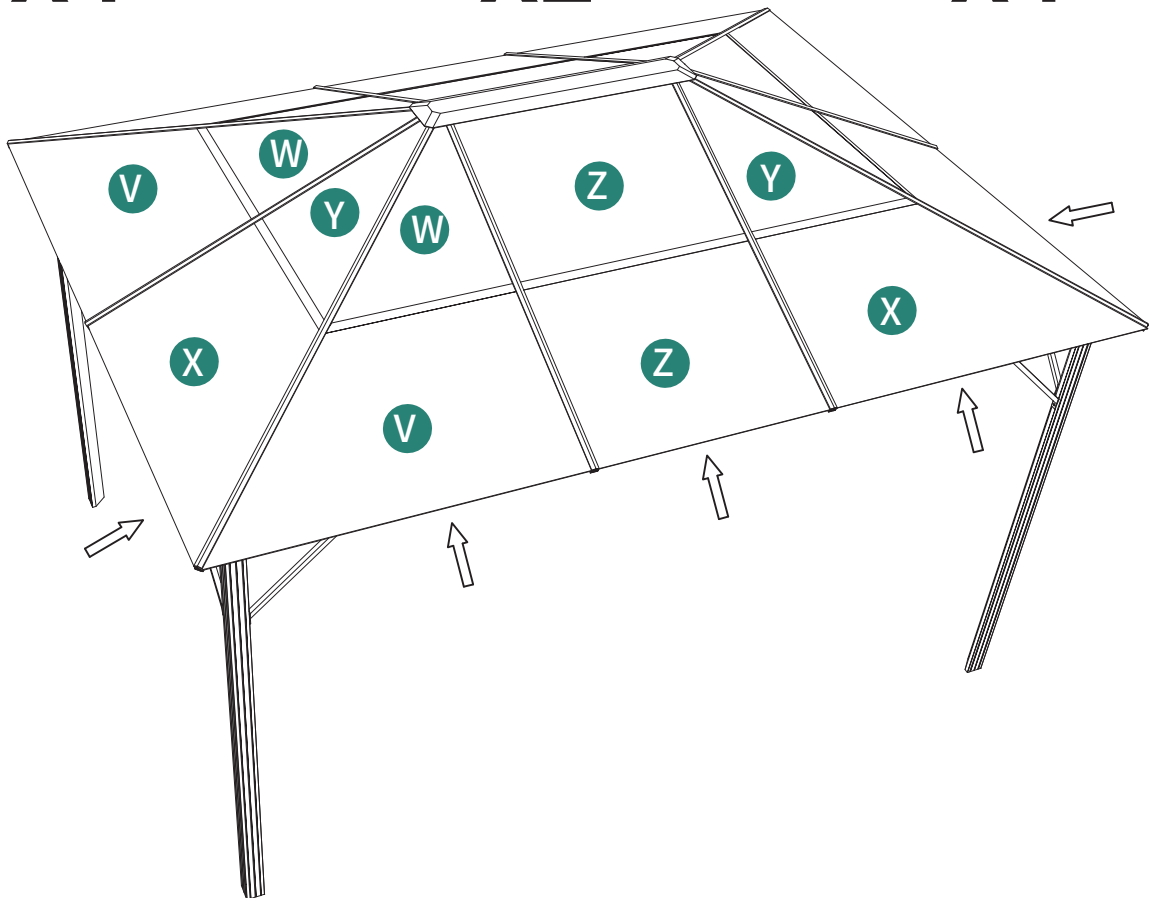
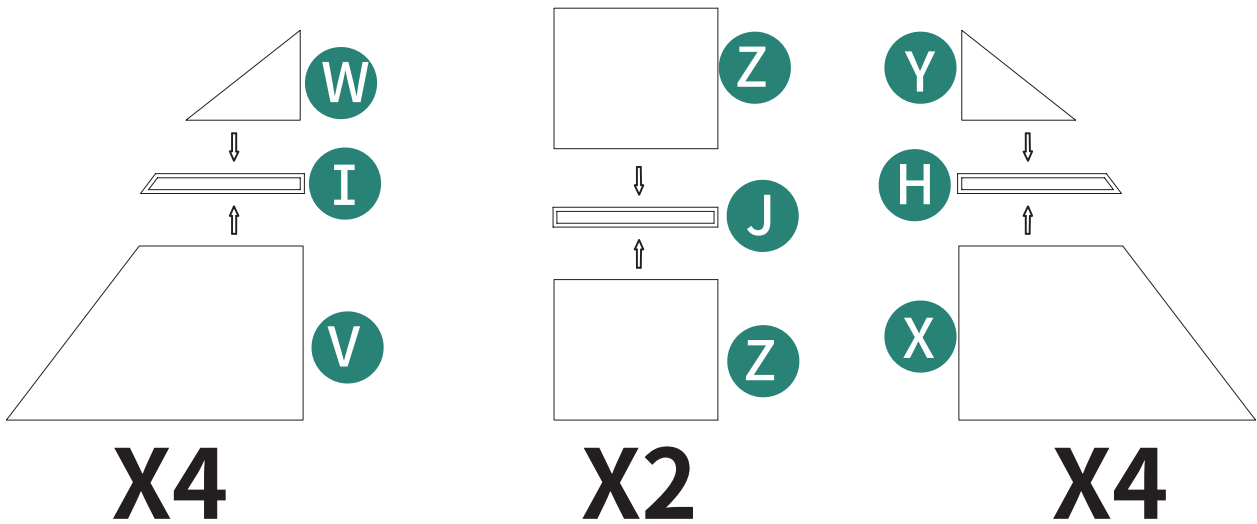

10



Ⓛ 8pcs



Ⓜ 2pcs



Ⓣ 6pcs



Ⓤ 4pcs



① 10pcs



③ 20pcs

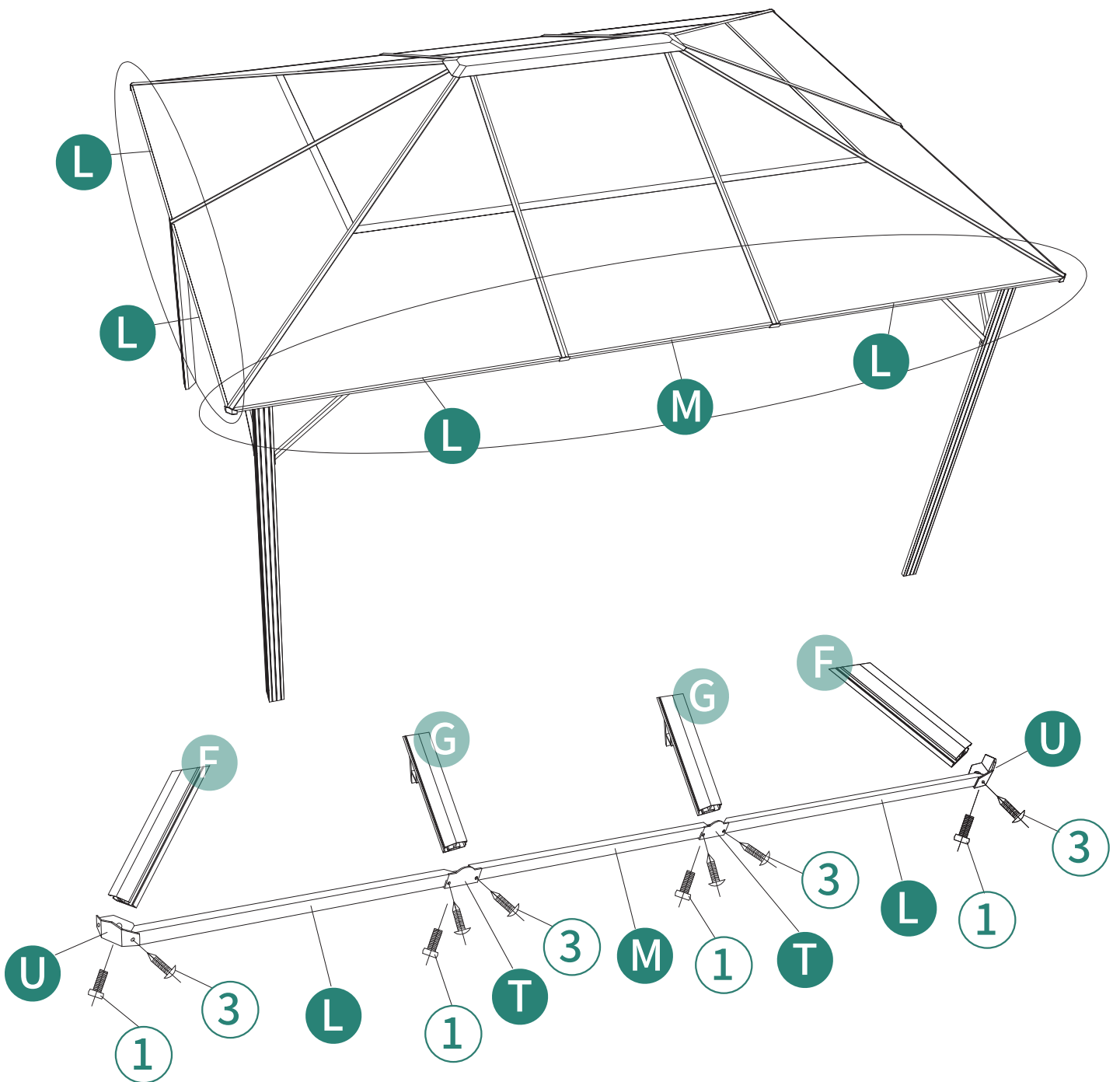

ASSEMBLY INSTRUCTIONS

11

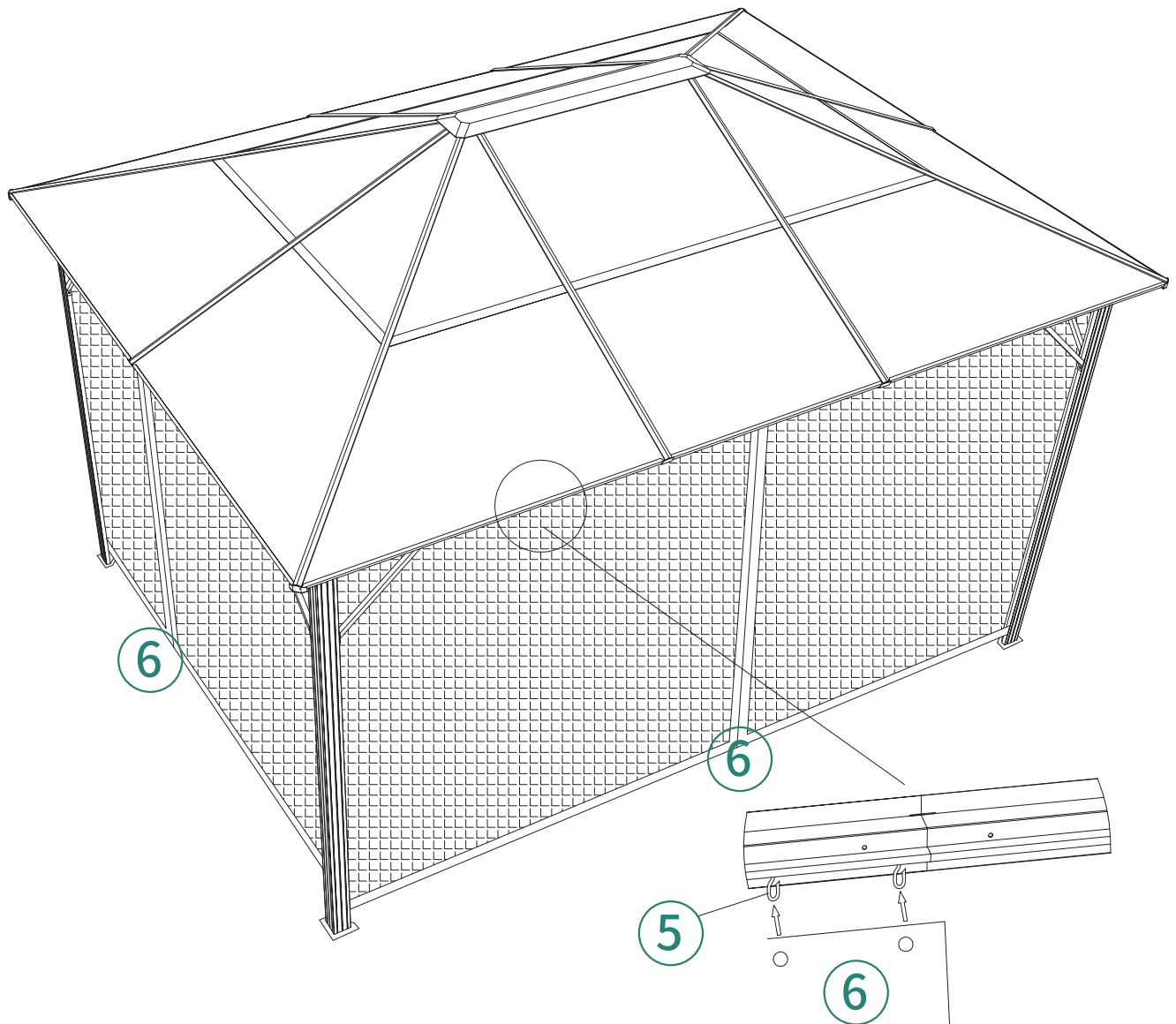
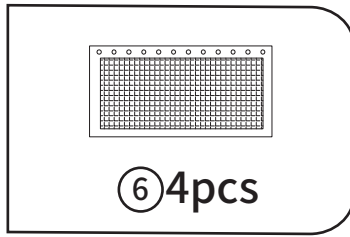

ASSEMBLY INSTRUCTIONS

12

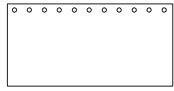

⑦ 4pcs

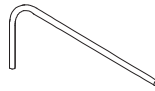

⑨ 8pcs

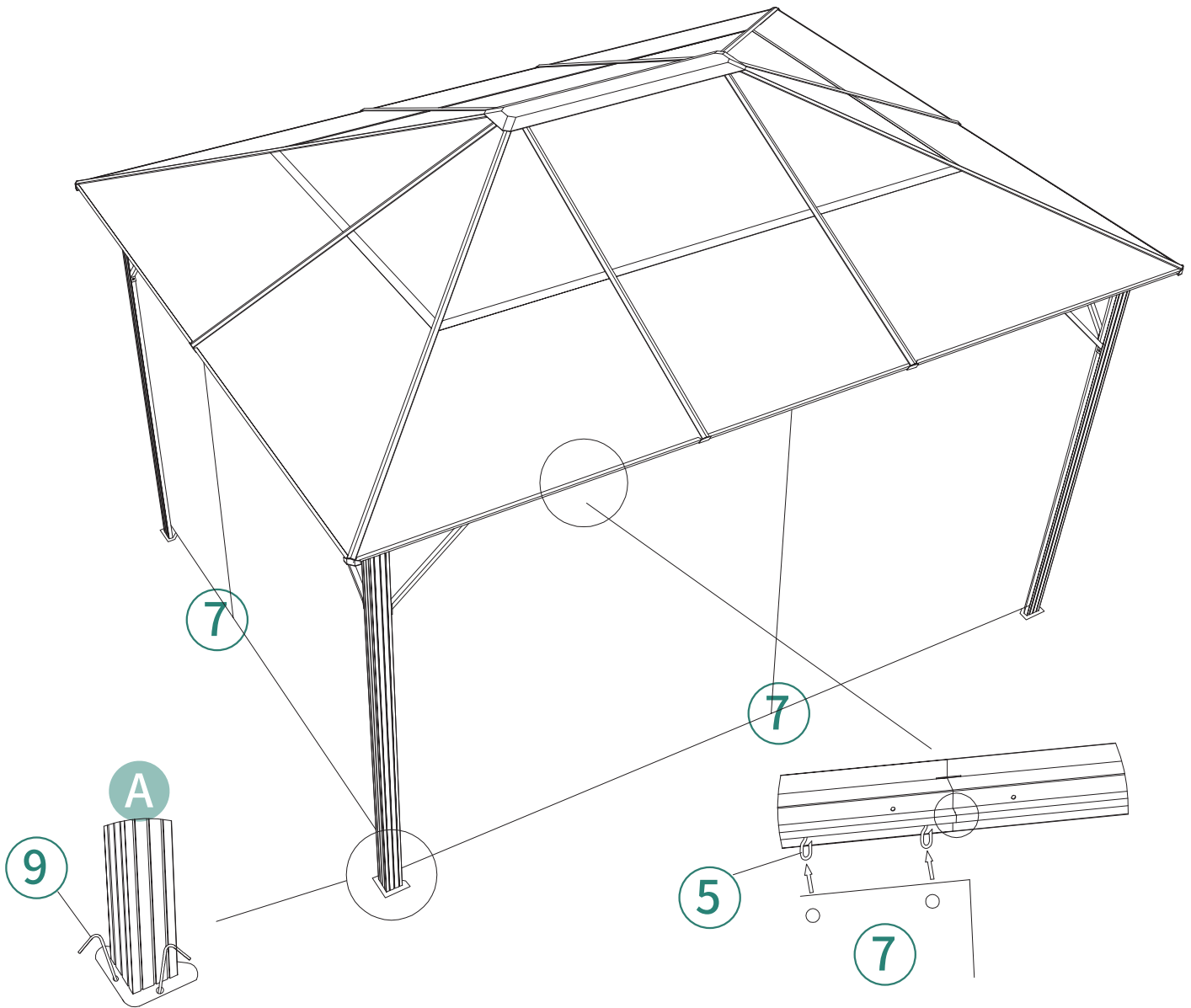

13

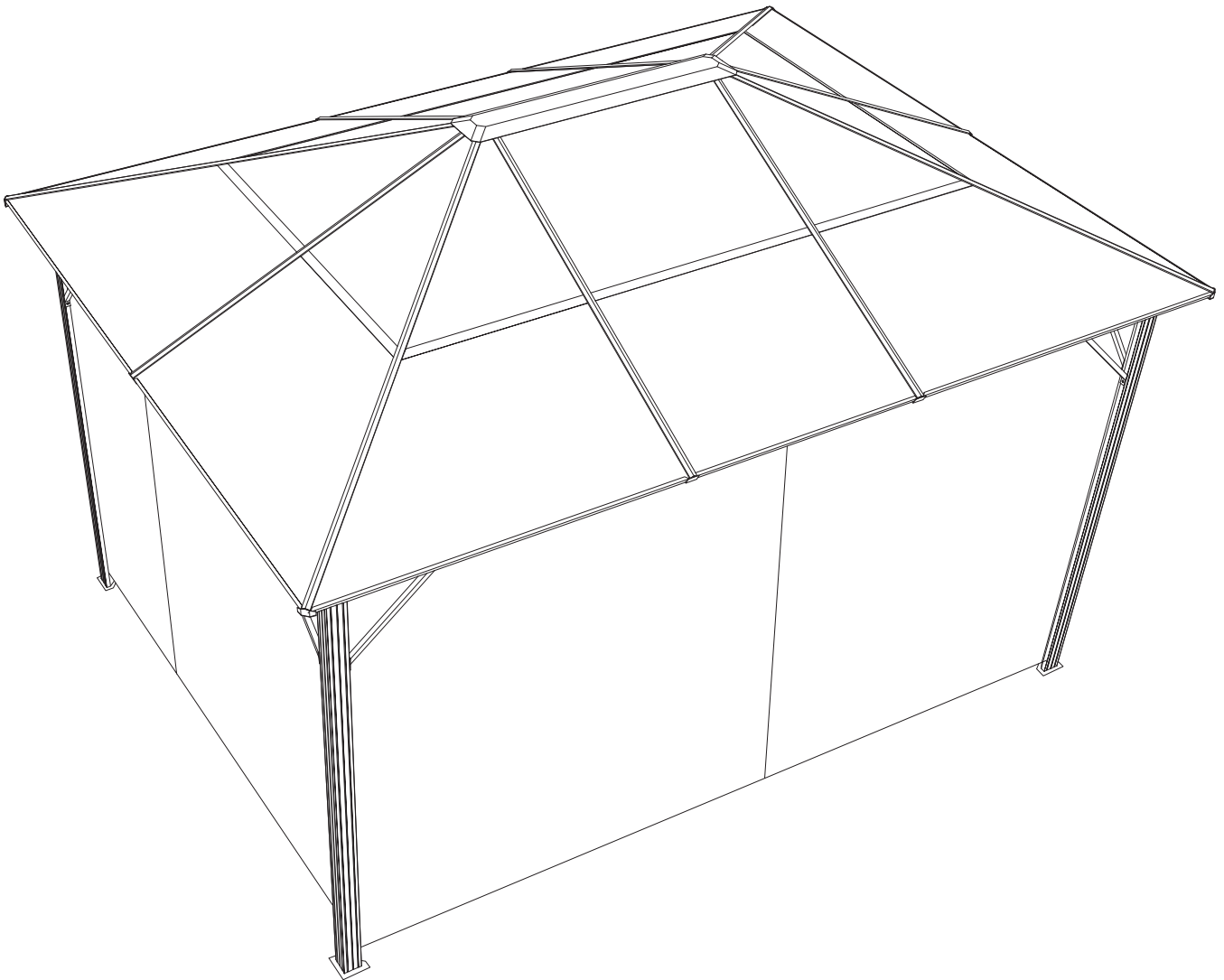

Installation Completed